

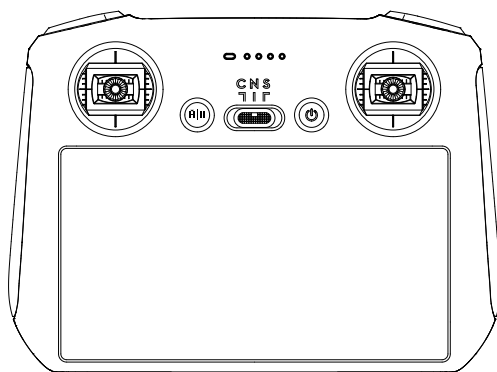

User Manual v1.0 2022.05



Searching for Keywords

Search for keywords such as “battery” and “install” to find a topic. If you are using Adobe Acrobat Reader to read this document, press Ctrl+F on Windows or Command+F on Mac to begin a search.

Navigating to a Topic

View a complete list of topics in the table of contents. Click on a topic to navigate to that section.

Printing this Document

This document supports high resolution printing.

Using this Manual

Legend

 Important

 Hints and Tips

 Reference

Read Before the First Use

Read the following documents before using the DJI™ RC.

1. Product Information
2. User Manual

It is recommended to watch all tutorial videos on the official DJI website and read product information before using for the first time. Refer to this user manual for more information.

Video Tutorials

Go to the address below or scan the QR code to watch the DJI RC tutorial videos, which demonstrate how to use the DJI RC safely.



<https://s.dji.com/guide23>

Contents

Using this Manual	2
Legend	2
Read Before the First Use	2
Video Tutorials	2
Product Profile	4
Introduction	4
Overview	5
Preparing the Remote Controller	6
Charging the Battery	6
Mounting	6
Activating the Remote Controller	7
Remote Controller Operations	8
Checking the Battery Level	8
Powering On/Off	8
Linking the Remote Controller	8
Controlling the Aircraft	9
Controlling the Gimbal and Camera	12
Customizable Buttons	12
Status LED and Battery Level LEDs Description	13
Remote Controller Alert	13
Touchscreen	14
Home	14
Operations	15
Quick Settings	16
Calibrating the Compass	17
Firmware Update	17
Appendix	18
Specifications	18

Product Profile

Introduction

The DJI RC remote controller features OCUSYNC™ image transmission technology, which transmits a live HD view from the camera of an aircraft supporting the OcuSync technology. ^[1] The remote controller is equipped with a wide range of controls and customizable buttons, enabling users to easily control the aircraft and remotely change aircraft settings at a distance of up to 15 km. ^[2] The remote controller works at both 2.4 and 5.8 GHz and is capable of selecting the best transmission channel automatically. The remote controller has a maximum operating time of four hours. ^[3] The remote controller is pre-installed with the DJI Fly app, enabling users to check the flight status and set flight and camera parameters. The mobile devices can connect directly to the aircraft via Wi-Fi for image transmission, enabling users to download photos and videos from the aircraft camera to the mobile device. Users can enjoy faster and more convenient downloads without using the remote controller.

Touch Screen: The built-in 5.5-in bright 700 cd/m² screen boasts a resolution of 1920×1080 pixels.

Multiple Connection Options: The Android operating system comes with a variety of functions, such as Bluetooth and GNSS. Users can connect to the internet via Wi-Fi.

Extended Storage Capability: The remote controller supports a microSD card to cache photos and videos, enabling users to preview the photos and videos on the remote controller. ^[4]

Reliable in More Environments: The remote controller can operate normally within a wide temperature range from -10° to 40° C (14° to 104° F).

[1] When used with different aircraft hardware configurations, the remote controller will automatically select the corresponding firmware version to update and support the following transmission technologies enabled by the hardware performance of the linked aircraft models:

- a. DJI Mini 3 Pro: O3
- b. DJI Mavic 3: O3+

[2] The maximum transmission distance (FCC) was tested in a wide-open area with no electromagnetic interference at an altitude of approximately 400 ft (120m).

- a. The maximum transmission distance (FCC) is 15 km when linked with DJI Mavic 3.
- b. The maximum transmission distance (FCC) is 12 km when linked with DJI Mini 3 Pro.

[3] The maximum operating time was tested in a lab environment and is for reference only.

[4] It is recommended to insert a microSD card.

Overview

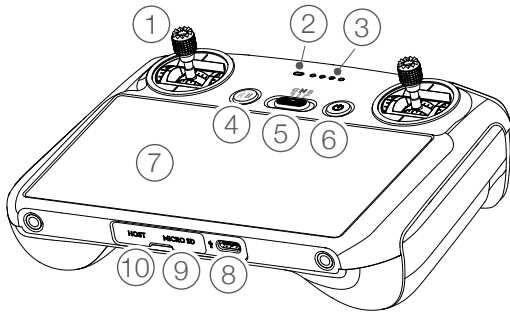

1. Control Sticks

Use the control sticks to control the movement of the aircraft. The control sticks are removable and easy to store. Set the flight control mode in DJI Fly.

2. Status LED

Indicates the status of the remote controller.

3. Battery Level LEDs

Displays the current battery level of the remote controller.

4. Flight Pause/Return to Home (RTH) Button

Press once to make the aircraft brake and hover in place (only when GNSS or Vision Systems are available). Press and hold to initiate RTH. Press again to cancel RTH.

5. Flight Mode Switch

Switch between Cine, Normal, and Sport mode.

6. Power Button

Press once to check the current battery level. Press, and then press and hold to power the remote controller on or off. When the remote controller is powered on, press once to turn the touchscreen on or off.

7. Touchscreen

Touch the screen to operate the remote controller. Note that the touchscreen is not waterproof. Operate with caution.

8. USB-C Port

For charging and connecting the remote controller to your computer.

9. microSD Card Slot

For inserting a microSD card.

10. Host Port (USB-C)

Reserved.

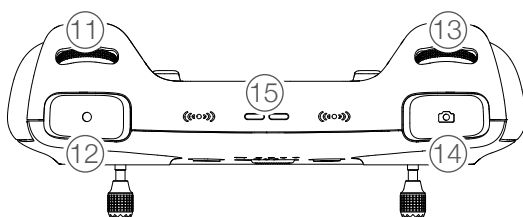

11. Gimbal Dial

Controls the tilt of the camera.

12. Record Button

Press once to start or stop recording.

13. Camera Control Dial

For zoom control.

14. Focus/Shutter Button

Press halfway down on the button to auto focus and press all the way down to take a photo.

15. Speaker

Outputs sound.

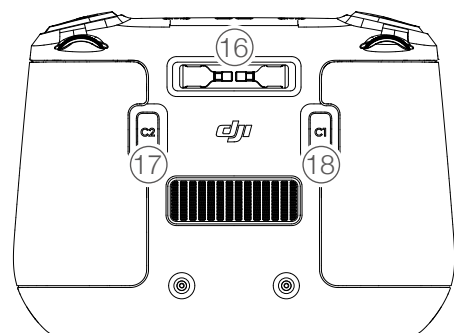

16. Control Sticks Storage Slot

For storing the control sticks.

17. Customizable C2 Button

Switch between recentering the gimbal and pointing the gimbal downward. The function can be set in DJI Fly.

18. Customizable C1 Button

Switch between recentering the gimbal and pointing the gimbal downward. The function can be set in DJI Fly.

Preparing the Remote Controller

Charging the Battery

Use a USB-C cable to connect a USB charger to the USB-C port of the remote controller. The battery can be fully charged in about 1 hour and 30 minutes with a maximum charging power of 15 W (5V/3A).

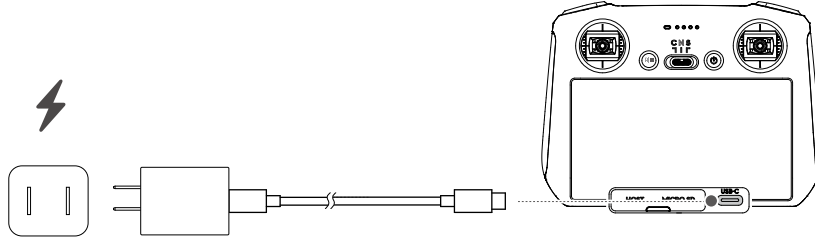

- It is recommended to use a USB Power Delivery charger.
- Recharge the battery at least every three months to prevent over discharging. The battery depletes when stored for an extended period.

Mounting

Remove the control sticks from the storage slots on the remote controller and screw them into place. Make sure the control sticks are firmly mounted.

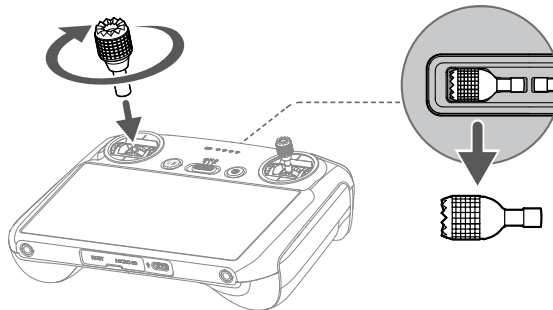

Activating the Remote Controller



The remote controller needs to be activated before using for the first time. Make sure the remote controller can connect to the internet during activation. Follow the steps below to activate the remote controller.

1. Power on the remote controller. Select the language and tap “Next”. Carefully read the terms of use and privacy policy and tap “Agree”. After confirming, set the country/region.
2. Connect the remote controller to the internet via Wi-Fi. After connecting, tap “Next” to continue and select the time zone, date, and time.
3. Log in with your DJI account. If you do not have an account, create a DJI account and log in.
4. Tap “Activate” on the activation page.
5. After activating, select if you would like to join the improvement project. The project helps to improve the user experience by sending diagnostic and usage data automatically every day. No personal data will be collected by DJI.



- Check the internet connection if the activation fails. If the internet connection is normal, please try to activate the remote controller again. Contact DJI Support if the issue persists.
-

Remote Controller Operations

Checking the Battery Level

Press the power button once to check the current battery level.

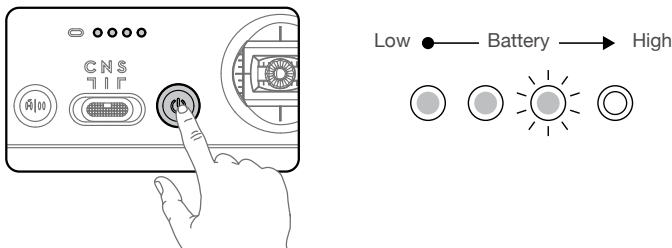

Powering On/Off

Press and then press again and hold to power the remote controller on or off.

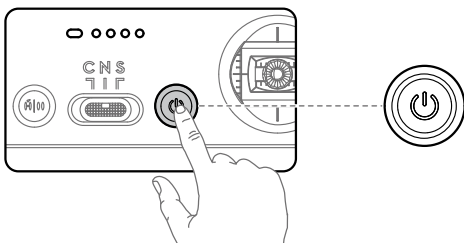

Linking the Remote Controller

The remote controller is already linked to the aircraft when purchased together as a combo. Otherwise, follow the steps below to link the remote controller and the aircraft after activation.

1. Power on the aircraft and the remote controller.
2. Launch DJI Fly.
3. In camera view, tap ●●● and select Control and then Pair to Aircraft (Link).
4. Press and hold the power button on the aircraft for more than four seconds. The aircraft will beep once when it is ready to link. After the linking is successful, the aircraft will beep twice and the battery level LEDs of the remote controller will appear on and solid.



- Make sure the remote controller is within 0.5 m of the aircraft during the linking.
- The remote controller will automatically unlink from an aircraft if a new remote controller is linked to the same aircraft.
- Turn off Bluetooth and Wi-Fi of the remote controller for optimal video transmission.



- Fully charge the remote controller before each flight. The remote controller sounds an alert when the battery level is low.
- If the remote controller is powered on and not in use for five minutes, an alert will sound. After six minutes, the remote controller automatically powers off. Move the control sticks or press any button to cancel the alert.
- Fully charge the battery at least once every three months to maintain the battery's health.

Controlling the Aircraft

The control sticks control the aircraft's orientation (pan), forward/backward movement (pitch), altitude (throttle), and left/right movement (roll). The control stick mode determines the function of each control stick movement. Three preprogrammed modes (Mode 1, Mode 2, and Mode 3) are available and custom modes can be configured in DJI Fly.

Mode 1

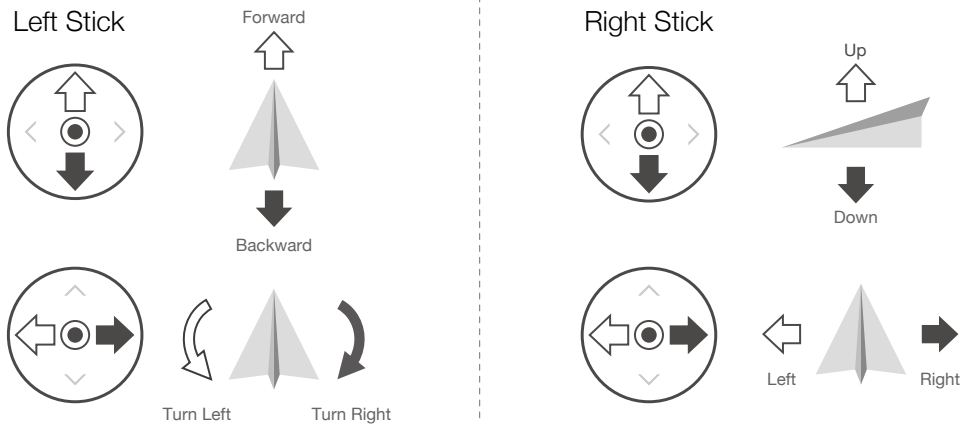

Mode 2

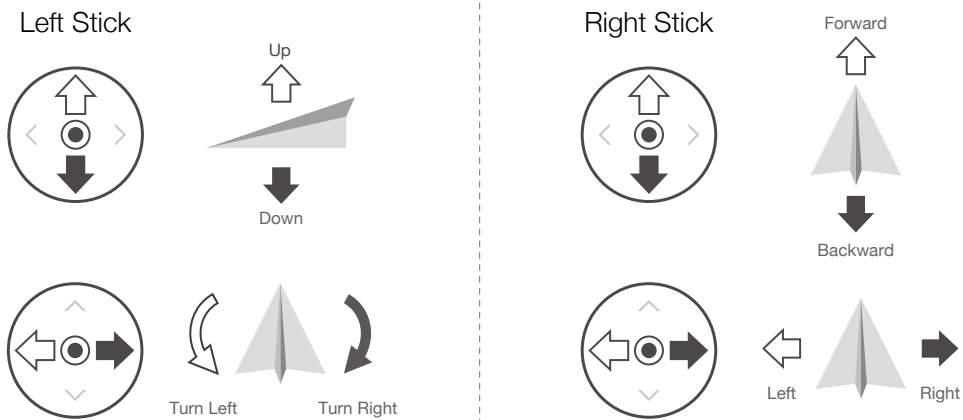



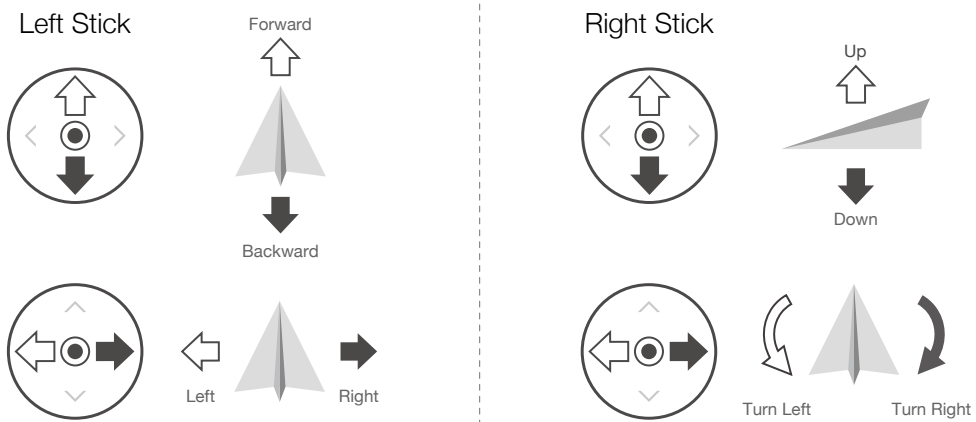

Mode 3

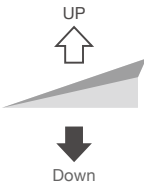
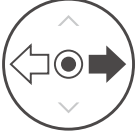
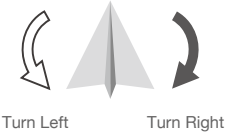

The default control mode of the remote controller is Mode 2. In this manual, Mode 2 is used as the example to illustrate how to use the control sticks.

-  • Stick Neutral/Center Point: Control sticks are in the center.
- Moving the control stick: The control stick is pushed away from the center position.

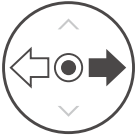
The figure below explains how to use each control stick. Mode 2 has been used as an example.

Remote Controller (Mode 2)	Aircraft	Remarks
Left Stick 		Moving the left stick up or down changes the aircraft's altitude. Push the stick up to ascend and down to descend. The more the stick is pushed away from the center position, the faster the aircraft will change altitude. Push the stick gently to prevent sudden and unexpected changes in altitude.
Left Stick 		Moving the left stick to the left or right controls the orientation of the aircraft. Push the stick left to rotate the aircraft counter-clockwise and right to rotate the aircraft clockwise. The more the stick is pushed away from the center position, the faster the aircraft will rotate.
Right Stick 		Moving the right stick up and down changes the aircraft's pitch. Push the stick up to fly forward and down to fly backward. The more the stick is pushed away from the center position, the faster the aircraft will move.
Right Stick 		Moving the right stick to the left or right changes the aircraft's roll. Push the stick left to fly left and right to fly right. The more the stick is pushed away from the center position, the faster the aircraft will move.

-  • Keep the remote controller away from magnetic materials to avoid it being affected by magnetic interference.
- To avoid damage, it is recommended that the control sticks are removed and stored in the storage slot on the remote controller during transportation or storage.

Flight Mode Switch

Toggle the switch to select the desired flight mode.

Position	Flight Mode
C	Cine Mode
N	Normal Mode
S	Sport Mode

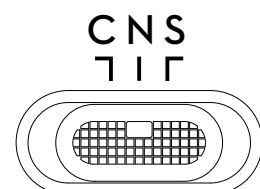

Normal Mode: The aircraft utilizes GNSS and the Vision Systems and Infrared Sensing System to locate and stabilize itself. When the GNSS signal is strong, the aircraft uses GNSS to locate and stabilize itself. When the GNSS is weak but the lighting and other environment conditions are sufficient, the aircraft uses the vision systems to locate and stabilize itself.

Sport Mode: In Sport Mode, the aircraft uses GNSS for positioning and the aircraft responses are optimized for agility and speed making it more responsive to control stick movements. Note that obstacle sensing is disabled in Sport Mode.

Cine Mode: Cine mode is based on Normal mode and the flight speed is limited, making the aircraft more stable during shooting.

-
-  • Refer to the flight modes section in the aircraft's user manual for more information about flight mode features for different aircraft types.
-

Flight Pause/RTH Button

Press once to make the aircraft brake and hover in place. Press and hold the button until the remote controller beeps to start RTH, the aircraft will return to the last recorded Home Point. Press this button again to cancel RTH and to regain control of the aircraft.

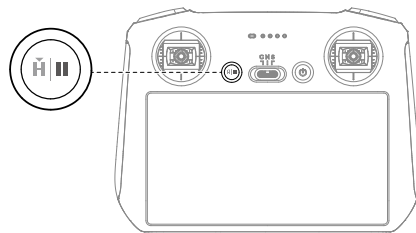

Optimal Transmission Zone

The signal between the aircraft and the remote controller is most reliable when the remote controller is positioned towards the aircraft as depicted below.

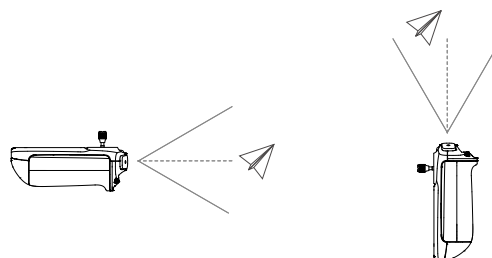

-
-  • DO NOT use other wireless devices operating at the same frequency as the remote controller. Otherwise, the remote controller will experience interference.
- A prompt will be displayed in DJI Fly if the transmission signal is weak during flight. Adjust the remote controller orientation to make sure that the aircraft is in the optimal transmission range.
-

Controlling the Gimbal and Camera

The remote controller can be used to control the gimbal and camera. The photos and videos are stored in the aircraft and can be previewed on the remote controller. The QuickTransfer function allows the mobile device to connect to the aircraft directly via Wi-Fi. Users can download photos and videos to the mobile device without using the remote controller.

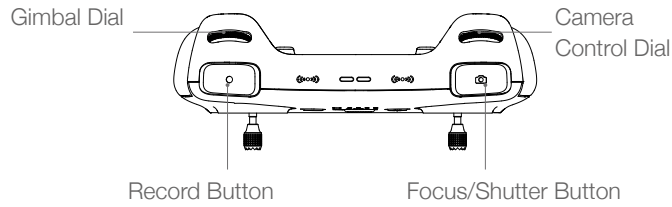

Focus/Shutter Button: Press halfway down to auto-focus and press all the way down to take a photo.

Record Button: Press once to start or stop recording.

Camera Control Dial: Adjust the zoom.

Gimbal Dial: Control the tilt of the gimbal.





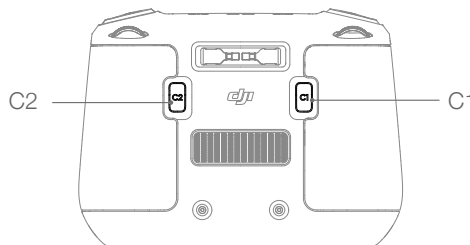



Customizable Buttons

The customizable buttons include C1 and C2. Go to System Settings in DJI Fly and select Control to set the functions of the customizable C1 and C2 buttons.



















Status LED and Battery Level LEDs Description

Status LED

Blinking Pattern	Description
 ———	Solid red Disconnected from the aircraft
	Blinking red The battery level of the aircraft is low
 ———	Solid green Connected with the aircraft
	Blinking blue The remote controller is linking to an aircraft
 ———	Solid yellow Firmware update failed
 ———	Solid blue Firmware update successful
	Blinking yellow The battery level of the remote controller is low
	Blinking cyan Control sticks not centered

Battery Levels LEDs

Blinking Pattern				Battery Level
				75%~100%
				50%~75%
				25%~50%
				0%~25%

Remote Controller Alert

The remote controller beeps when there is an error or warning. Pay attention when prompts appear on the touchscreen or in DJI Fly. Slide down from the top and select Mute to disable all alerts, or slide the volume bar to 0 to disable some alerts.

The remote controller sounds an alert during RTH. The RTH alert cannot be cancelled. The remote controller sounds an alert when the battery level of the remote controller is low (6% to 10%). A low battery level alert can be cancelled by pressing the power button. The critical low battery level alert, which is triggered when the battery level is less than 5%, cannot be cancelled.

Touchscreen

Home

The remote controller is pre-installed with the DJI Fly app. Power on the remote controller to enter the home screen of DJI Fly.

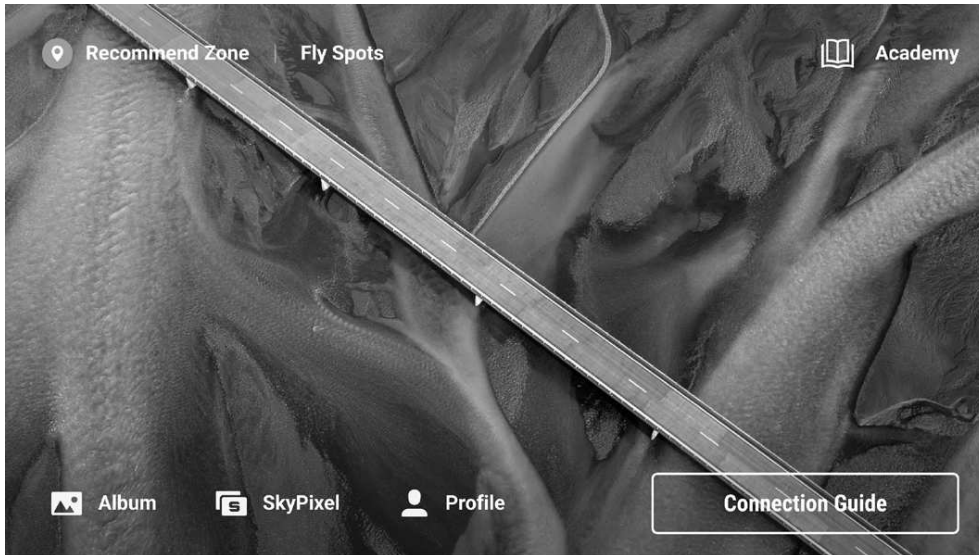

Fly Spots

View or share suitable flight and shooting locations nearby, learn more about GEO Zones, and preview aerial photos of different locations taken by other users.

Academy

Tap the icon in the top right corner to enter Academy and view product tutorials, flight tips, flight safety notices, and manual documents.

Album

View photos and videos from the aircraft and DJI Fly.

SkyPixel

Enter SkyPixel to view videos and photos shared by users.

Profile

View account information, flight records; visit the DJI forum, online store; access the Find My Drone feature, and other settings such as firmware updates, camera view, cached data, account privacy, and language.

Since the DJI RC is compatible with multiple aircraft models and the interface of DJI Fly may vary depending on the aircraft model, refer to the DJI Fly app section in the user manual of the relevant aircraft for more information.

Operations

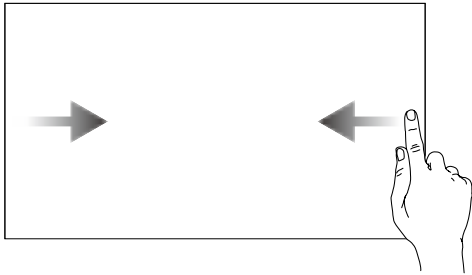

Slide from the left or right to the center of the screen to return to the previous screen.

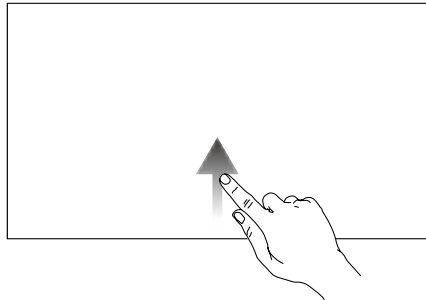

Slide up from the bottom of the screen to return to DJI Fly.

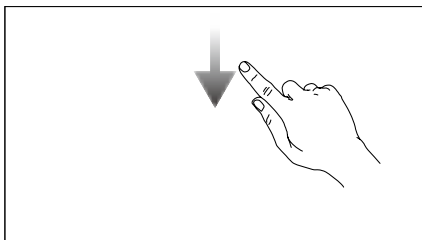

Slide down from the top of the screen to open the status bar when in DJI Fly. The status bar displays the time, Wi-Fi signal, battery level of the remote controller, etc.

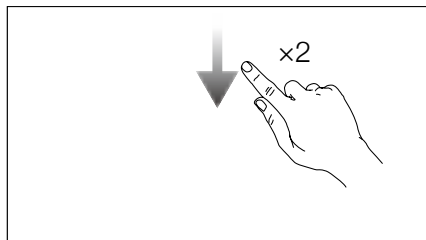

Slide down twice from the top of the screen to open Quick Settings when in DJI Fly.

Quick Settings

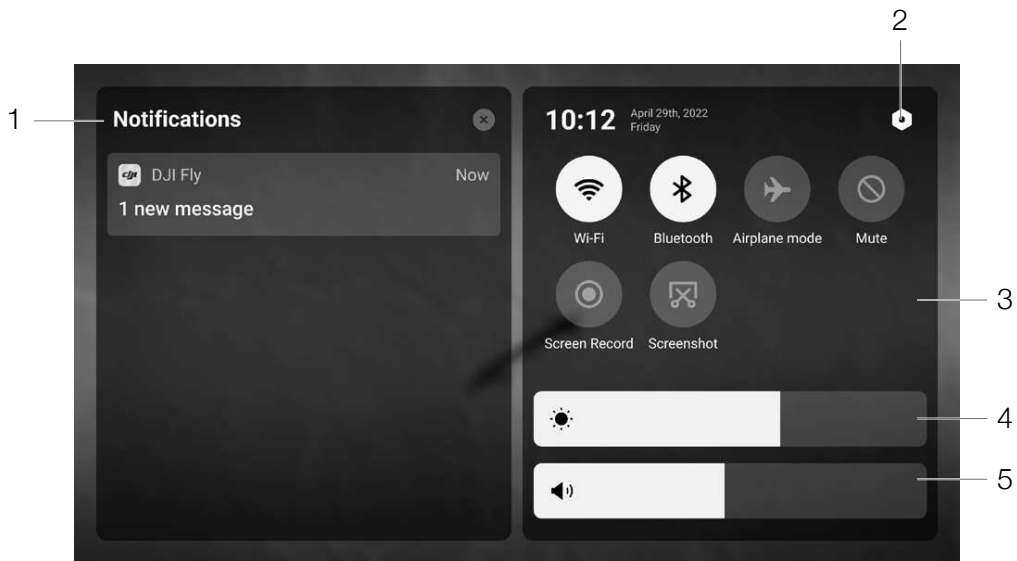

1. Notifications

Tap to check system notifications.

2. System Settings

Tap  to access system settings and configure the Bluetooth, volume, network, etc. You can also view the Guide to learn more about the controls and status LEDs.

3. Shortcuts

 : Tap to enable or disable Wi-Fi. Hold to enter settings and then connect to or add a Wi-Fi network.

 : Tap to enable or disable Bluetooth. Hold to enter settings and connect with nearby Bluetooth devices.

 : Tap to enable Airplane mode. Wi-Fi and Bluetooth will be disabled.

 : Tap to turn off system notifications and disable all alerts.

 : Tap to start recording the screen*. The function will be available only after a microSD card is inserted into the microSD slot on the remote controller.

 : Tap to take a screenshot. The function will be available only after a microSD card is inserted into the microSD slot on the remote controller.

4. Adjusting Brightness

Slide the bar to adjust the screen brightness.

5. Adjusting Volume

Slide the bar to adjust the volume.

* When the remote controller is linked with DJI Mavic 3, the frame rate of the transmission image will drop to 30fps during the recording.

Calibrating the Compass

The compass may need to be calibrated after the remote controller is used in areas with electromagnetic interference. Follow the steps below to calibrate your remote controller.

1. Power on the remote controller, and enter Quick Settings.
2. Tap  enter system settings, scroll down and tap Compass.
3. Follow the on-screen instructions to calibrate the compass.
4. A prompt will be displayed when the calibration is successful.

Firmware Update

When the remote controller is linked with the aircraft, a prompt will appear if new firmware is available. Tap the prompt and follow the instructions to update the remote controller. The remote controller automatically restarts when the update is complete. Make sure the remote controller is connected to the internet during the update.



- The remote controller is pre-installed with the DJI Fly app. You can update the remote controller without the aircraft being linked. Power on the remote controller and enter the home screen of DJI Fly. Tap Profile > Settings > Firmware Update > Check for Firmware Update, and then follow the instructions to update the remote controller.



- Make sure the remote controller has a battery level of more than 20% before updating.
 - The update takes approximately 15 minutes. The time it takes to download the update varies depending on the internet speed. Make sure the remote controller has access to the internet during the update.
-

Appendix

Specifications

Transmission	
Transmission System	When used with different aircraft hardware configurations, DJI RC Remote Controllers will automatically select the corresponding firmware version for updating and support the following transmission technologies enabled by the hardware performance of the linked aircraft models: a. DJI Mini 3 Pro: O3 b. DJI Mavic 3: O3+
Operation Frequency Range	2.4000-2.4835 GHz, 5.725-5.850 GHz ^[1]
Max Transmission Distance (Unobstructed, free of interference)	When used with DJI Mini 3 Pro: 12 km (FCC), 8 km (CE/SRRC/MIC) When used with DJI Mavic 3: 15 km (FCC), 8 km (CE/SRRC/MIC)
Transmission Power (EIRP)	2.4 GHz: <26 dBm (FCC), <20 dBm (CE/SRRC/MIC) 5.8 GHz: <26 dBm (FCC), <23 dBm (SRRC), <14 dBm (CE)
Signal Transmission Ranges (FCC) ^[2]	When used with DJI Mini 3 Pro: Strong interference (e.g., city center): Approx. 1.5-3 km Moderate interference (e.g., suburbs, small towns): Approx. 3-7 km No interference (e.g., rural areas, beaches): Approx. 7-12 km When used with DJI Mavic 3: Strong interference (e.g., city center): Approx. 1.5-3 km Moderate interference (e.g., suburbs, small towns): Approx. 3-9 km No interference (e.g., rural areas, beaches): Approx. 9-15 km
Wi-Fi	
Protocol	802.11a/b/g/n
Operating Frequency	2.4000-2.4835 GHz; 5.150-5.250 GHz; 5.725-5.850 GHz
Transmitter Power (EIRP)	2.4 GHz: < 23 dBm (FCC), < 20 dBm (CE/SRRC/MIC) 5.1 GHz: < 23 dBm (FCC/CE/SRRC/MIC) 5.8 GHz: < 23 dBm (FCC/SRRC), < 14 dBm (CE)
Bluetooth	
Protocol	Bluetooth 4.2
Operating Frequency	2.4000-2.4835 GHz
Transmitter Power (EIRP)	< 10 dBm
General	
Battery Capacity	5200 mAh
Battery Type	Li-ion
Chemical System	LiNiMnCoO2
Operating Current/Voltage	1250 mA@3.6 V
Charging Type	USB Type-C
Rated Power	4.5 W
Storage Capacity	microSD card supported
Supported microSD Cards for DJI RC Remote Controller	UHS-I Speed Grade 3 rating and above

Recommended microSD Cards for DJI RC Remote Controller	SanDisk Extreme 64GB V30 A1 microSDXC SanDisk Extreme 128GB V30 A2 microSDXC SanDisk Extreme 256GB V30 A2 microSDXC SanDisk Extreme 512GB V30 A2 microSDXC SanDisk Extreme Pro 64GB V30 A2 microSDXC SanDisk Extreme Pro 256GB V30 A2 microSDXC SanDisk Extreme Pro 400GB V30 A2 microSDXC SanDisk High Endurance 64GB V30 microSDXC SanDisk High Endurance 256GB V30 microSDXC Kingston Canvas Go Plus 64GB V30 A2 microSDXC Kingston Canvas Go Plus 256GB V30 A2 microSDXC Lexar High Endurance 64GB V30 microSDXC Lexar High Endurance 128GB V30 microSDXC Lexar 633x 256GB V30 A1 microSDXC Lexar 1066x 64GB V30 A2 microSDXC Samsung EVO Plus 512GB microSDXC
Charging Time	1 hr 30 mins @5V3A 2 hrs 20 mins @5V2A
Operating Time	4 hrs
Operation Temperature Range	-10 °C to 40 °C (14° to 104° F)
Storage Temperature Range	Less than one month: -30° to 60° C (-22° to 140° F) One to three months: -30° to 45° C (-22° to 113° F) Three to six months: -30° to 35° C (-22° to 95° F) More than six months: -30° to 25° C (-22° to 77° F)
Charging Temperature Range	5°C to 40°C (41° to 104° F)
Supported Aircraft Models ^[3]	DJI Mini 3 Pro DJI Mavic 3
GNSS	GPS+BEIDOU+Galileo
Weight	390 g
Model	RM330

[1] 5.8 GHz is unavailable in some countries due to local regulations.

[2] Data is tested under FCC standards in unobstructed environments of typical interference. Only to serve as a reference and provides no guarantee as to the actual flight distance.

[3] The DJI RC will support more DJI aircraft in future. Visit the official website for the latest information.

WE ARE HERE FOR YOU



Contact
DJI SUPPORT

This content is subject to change.
Download the latest version from



www.dji.com/rc/downloads

If you have any questions about this document, please contact
DJI by sending a message to **DocSupport@dji.com**.

DJI is a trademark of DJI.

Copyright © 2022 DJI All Rights Reserved.