

NCF USER'S MANUAL



DOWNLOAD APP

This APP can realize the functions of the vehicle such as, self-test, positioning, switch on/off, battery management, etc.

- ① Enter the Apple App Store or Google App Store to search for LINGO APP.
- ② Install and run this App and register.
- ③ Scan the QR code on the previous page in the APP to register your vehicle.

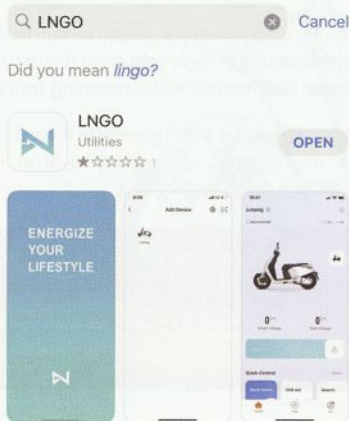

Notes.

1. Please refer to "LVNENG APP Operation Manual" for the specific operation of APP.
2. The cell phone system requirement is to make sure your cell phone system is Android 6.0 or iOS 8 or above.
3. Please make sure the phone is connected to the network (Wi-Fi or 4G) when running APP.

INSTRUCTIONS FOR USE

We are pleased to have you join the NCF family of owners! In order to ensure that you are able to use your vehicle in an appropriate and secure manner, we will walk you through the many functions that it possesses. Before you ride, please make it a point to thoroughly read this handbook and make sure that you always respect the following instructions. Doing so will not only ensure your own safety but also the safety of others around you.

- We ask that you read this handbook all the way through and make sure you completely comprehend its contents, including but not limited to the pertinent directions, cautions, and warnings.
- It is imperative that you have a complete understanding of how to operate the vehicle, as well as the safety procedures and warning labels that are located on the vehicle.
- We cannot be held liable for any performance and safety issues that arise as a result of unauthorized modifications, the non-use of original components, or the installation of items that are not original to the vehicle.
- Please ensure that you comply with all traffic rules and signs, always monitor the surrounding road conditions as well as the state of your vehicle, and take the necessary precautions to be safe.

Before each ride, perform a simple check to ensure that the lights, brakes, tread, and tire pressure are all in working order. Additionally, check to see if any other parts are loose or making an unexpected noise.

- Before beginning any ride, make sure you are equipped with the proper safety gear, such as a helmet, and suitable protective clothing, such as gloves and boots, if they are required.
- In order to prevent possible collisions with other vehicles, we ask that you refrain from picking up or making phone calls while we are moving.
- In well-lit situations, we ask that you kindly refrain from using your high beams. The consistent use of high lights can disrupt regular driving, as well as cause visual interference with oncoming traffic and pedestrians.
- Please refrain from operating a motor vehicle if you have recently taken a medicine that might impair your ability to drive, if you have been consuming alcohol, or if you are ill.

If you have any questions when using this product, please call the customer vehicle center in your area; we are always here to assist you. I hope you have a pleasant and worry-free trip!

PARTS DESCRIPTION

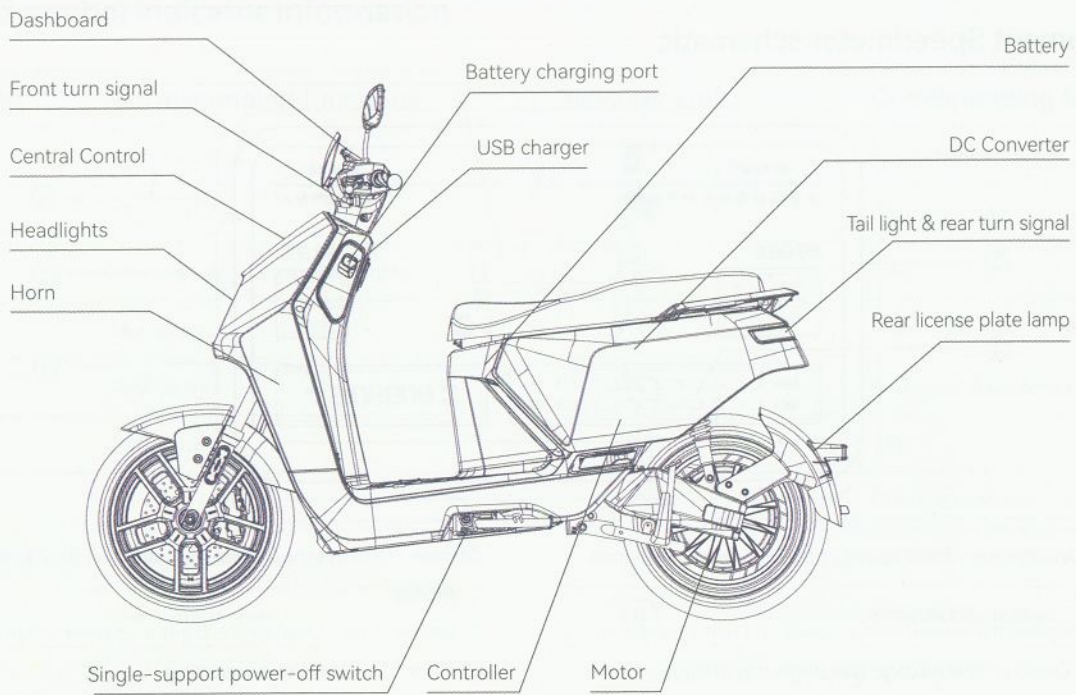

PARTS DESCRIPTION

Instrument Speedmeter schematic

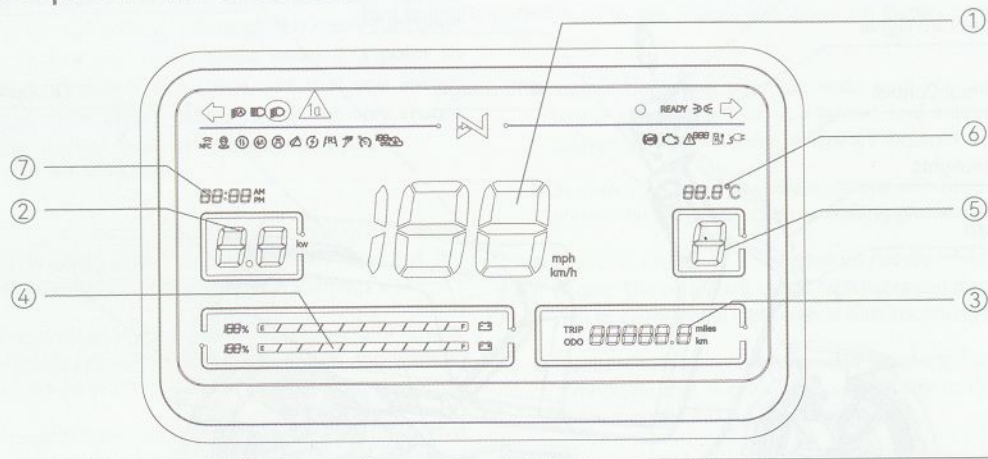

① Speed - Displays the current speed of the vehicle and real-time dynamics.

② Power - Displays the current motor power and real-time dynamics.

③ Mileage - Displays total mileage and single trip mileage.









④ Power - Displays the real-time battery status of both batteries.









⑤ Gear - Displays the current gear, and can display three gear shift modes.

⑥ Temperature - Displays the current ambient temperature.

⑦ Clock - Displays the current time.

Dashboard symbol indicator information

Indicator light	Corresponding functions
	Left turn signal
	Right turn signal
	Low beam & automatic headlights
	High beam
	Position light
	Park status
READY	Driveable status
	Single-support power off
	Seat cushion open

Indicator light	Corresponding functions
	Low battery
	Charging
	OBD
	Fault codes
	Cruise with fixed speed
	GPS
	OTA update status
	Bluetooth connection
	Network connection

OPERATING INSTRUCTIONS

Installation of rear view mirror

- ① Taking the left and right mirrors out from the box, insert them into the holes and rotate them clockwise to the correct position.
- ② Use a wrench to tighten the nuts to ensure that the left and right mirrors are in the same line and appropriate for the driver's view.

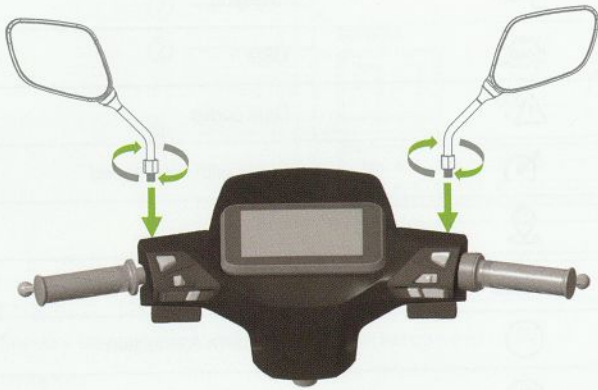

Left Combination Switch

- ① High / low beam buttons
Press up to turn on the high beam, press down to switch to the low beam.
- ② Turn signal button
Dial left to turn on the left turn signal, dial right to turn on the right turn signal, dial to the middle to turn off.
- ③ Horn button
Press and hold the horn to make a sound, release to turn off.
- ④ Speed button
Press it then the vehicle will cruise at the current speed, press again to exit cruise.



Right Combination Switch

- ① Gear button
Press the "+" or "-" button to upshift or downshift.
- ② Headlight button
Dial it to the right to turn off the headlights, dial it to the middle to turn on the headlights, and dial it to the left to enter the automatic headlight mode.
- ③ Repair button
When there is a fault display, press and hold it the vehicle can drive slowly, release it to stop.
- ④ Double flash button
Press it to open the left and right turn signals flashing at the same time, press it again to close.



OPERATING INSTRUCTIONS

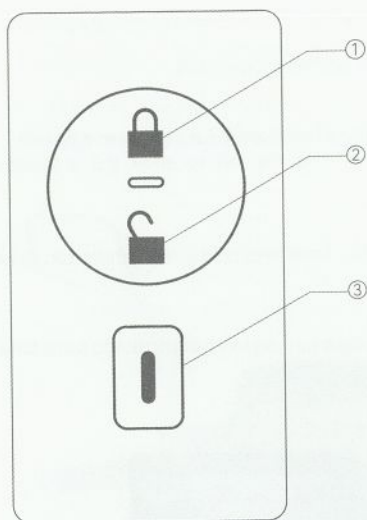

Remote controller

When using this remote key, you can easily lock or unlock the vehicle by simply pressing the button within the remote range.

① Lock

When the vehicle is in [Static], press this key, the front and rear turn signals will double flash once, and enter the [Locked state] at the same time.

② Unlock

Press this key, the front and rear turn signals will double flash once and enter the [unlocked state] at the same time.

③ Start

Press this key 2 times continuously within 2 seconds, the vehicle can enter the [power on state].

⚠ ATTENTION

After the whole vehicle is powered on, please ensure that the leading lock is open to prevent the danger of riding in the locked state.

Please operate with the solenoid valve unlocked:

- ① When the vehicle is in [Static], turn the handlebar to the far left, push forward and rotate to the left from the OFF state to lock the vehicle tap; then push forward and rotate to the right to open the vehicle tap and return to the OFF state.
- ② Rotate to the left from the OFF state and hear the [click] sound to open the saddle, while the knob will automatically return to the OFF state.
- ③ Rotate to the right from the OFF state, the vehicle can enter the power-up state; then rotate to the left, the vehicle returns to the OFF state.

Additional instructions for solenoid valve unlocking

You have the option of using any one of the three methods listed below to unlock the primary lock solenoid.

1. The mobile phone's Bluetooth connection has been established with the vehicle, and the solenoid valve has been opened after the cell phone has been recognized as being in close proximity to the vehicle.
2. While you are in close proximity to the vehicle, press the unlock button on the remote key, and the primary lock solenoid will unlock.
3. Place the mechanical key into the main lock, and the solenoid that controls the main lock should become unlocked.

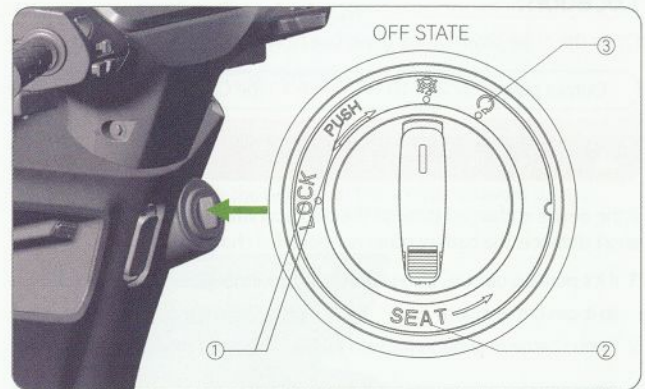

LOCK

OPERATING INSTRUCTIONS

Location:

Open the outer cover of the glove box to find a USB charging port.

Output power: 5V 2A / 10 W (Type A + Type C)

⚠ ATTENTION

If the device is charged through the USB port while the vehicle only goes a short distance, the battery could not get a full charge.

1. If it's pouring outside, please don't plug your gadget into the USB port so it can get charged.
2. If you charge external items with a USB cable, the range may be affected.



USB charging port

OPERATING INSTRUCTIONS

Location

There is a placement hook above the front windshield of the vehicle.

⚠ ATTENTION

The maximum load weight of this hook - 3kg



Hook

Placement of safety helmet:

1. Open the saddle and hang the helmet buckle on the hook.
2. Close the saddle and make sure the saddle is locked.

⚠ ATTENTION

When riding, do not lock the helmet on the scooter to avoid danger.

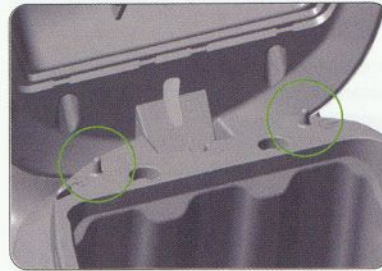

Helmet hook

RIDING GUIDELINES

Checks before riding

Before driving your vehicle, to ensure your safety on the road, please be aware of the following.

- Determine whether or not the handlebar's left and right steering is rigid and adaptable. Check to verify if the rearview mirror can be seen clearly and if it can be adjusted to the correct angle.
- Check to see if there is enough brake oil for the discs and that the braking system is operating correctly.
- Whether or not the surface of the tire has any problems such as cracks, bulges, foreign substances, wear, or any other issues.
- It is advised that the front and rear tires have a pressure of 225 kPa regardless of whether or not the tire pressure is normal.
- It is determined whether there is sufficient power in the battery and whether it has been fully charged. If both the left and right combination switches can be manipulated without any jerkiness and are functioning normally.
- Checking to see that the front lights, back lights, brake lights, and turn signals are all functioning as they should.

- Whether or not the trumpet operates as it should. Whether or not an error message appears on the instrument panel once the power has been turned on.

For any abnormality or operational concern, please contact local Customer Service Center.

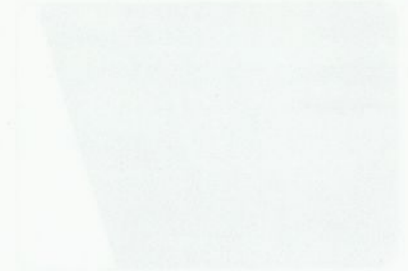

Confirmation of drivable status

Start the engine and turn on the power to the vehicle (you can choose the following 4 ways).

- ① Approach the vehicle while holding the remote key, push the on button, and turn the primary lock to the right.
- ② Utilize the APP and slide the unlock bar button located on the home page of the APP to the right.
- ③ Insert the mechanical key into the main lock and turn it to the right to unlock it.
- ④ Turn the primary lock to the right and press the button on the remote control that is labeled "unlock."



⚠ ATTENTION

After using the mechanical key to turn the power on, the permission is the first priority. Because of this, the mechanical key must still be used when powering down. At this time, using the remote key or the APP cannot power down the device.

2. Once the engine has been started, the front and rear position lights will light up, and at the same time, the instrument will be checked to see if it has power.

3. Because there is an induction strip buried inside the saddle, you need to make sure that the driver sits on the saddle. Once they do this, the instrument P-gear indication will be lifted, the READY light will be illuminated, and the vehicle will transition into the state of being able to be driven.

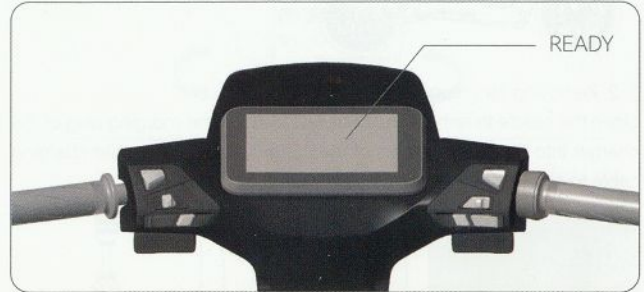

⚠ ATTENTION

Before you get on your bike, you need to put on a helmet, make sure the Single Support has been retracted, and check that the leading lock is in the open position.

BATTERY USE INSTRUCTIONS

How to charge the battery

1-1. Charging in the vehicle.

Open the outer cover of the glove box and insert the charging plug of the charger into the charging cradle of the vehicle.

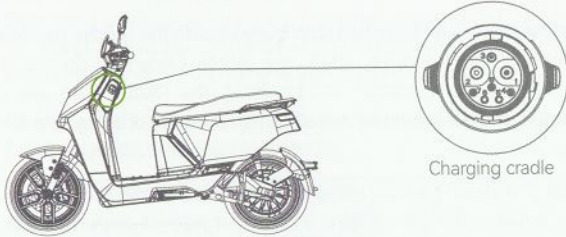

1-2. Removing for charging

Open the saddle to remove the battery and insert the charging plug of the charger into the charging port of the battery or use the parallel charging cable to charge at the same time.



Charging port

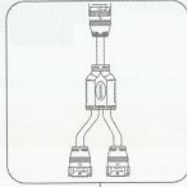

Parallel charging cable

2. Connect the charger to the household power outlet using the AC power cord; when the charger indicator turns red, it indicates that the battery is beginning to charge; when the charger indicator changes.

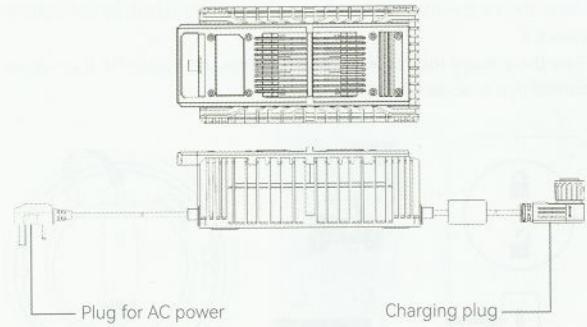

Plugging and unplugging of power plugs

1. The electrical connector's three holes that are perfectly aligned with the battery 3PIN must be pushed in until you hear a "click" sound; this indicates that it has been successfully inserted.

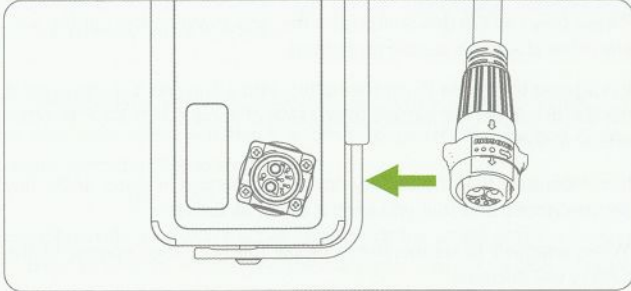

⚠ CAUTION

If the plug is not properly inserted, the power plug and socket may be damaged.

2. According to the arrow of the plug, holding the plug shell counterclockwise rotation to the end, and follow the trend upward, you can pull out the power plug.

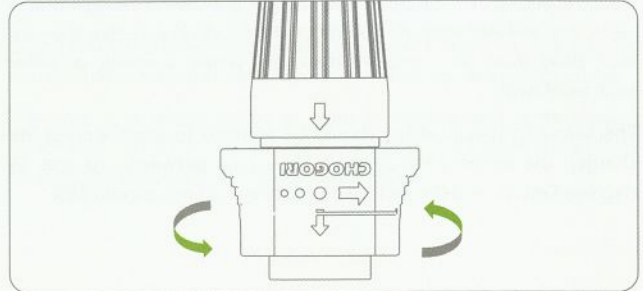

BATTERY USE INSTRUCTIONS

Storage, Transportation

Please make sure the battery is charged to a semi-saturated state before storing it or transporting it.

Please ensure that the battery and charger are kept in an area that is clean, dry, and well ventilated. Additionally, please ensure that they are kept away from any corrosive materials, power supplies, or other sources of heat.

The following specifications should be adhered to when storing the charger: the ambient temperature should be between -20 and 35 degrees Celsius, and the relative humidity should not exceed 65%.

Tips:

- Before the battery is allowed to leave the factory, it is disassembled and examined thoroughly, and consumers are not permitted to do so themselves.
- Please only use the designated charger, and charging the battery with any other charger is strictly prohibited.
- It is against the law to throw the battery into a fire, and it is also against the law to subject the battery to any kind of impact, extrusion, or other similar activity.
- It is imperative that the battery not be submerged in water under any circumstances, and that you keep it dry at all times.
- When exposed to temperatures below freezing, the capacity of the battery will decrease.
- If it is discovered that the battery is heating up too quickly while being charged, please wait one hour before charging it again.
- Before the battery capacity drops below 20%, could you please make sure that it has been charged?
- When you aren't going to be using the vehicle for a while, you need to take the battery out of it.
- Please ensure that the battery has been fully charged before use after being stored for an extended period of time.

ROUTINE CLEANING AND MAINTENANCE

Cleaning:

Please make sure the vehicle power is disconnected before cleaning.

When washing, please use water or a detergent that is neutral, and when cleaning the surface, please use a soft cloth or sponge, and after cleaning, please wipe dry with a soft cloth.

It is completely banned to clean the vehicle with a metal brush, sandpaper, or any other abrasive material in order to protect the surface of the components from being scratched.

Do not directly rinse with a water cannon that has a high pressure setting in order to prevent internal mechanical parts from failing due to water entering the system.

Regular maintenance:

Your vehicle will have a longer life and you will be safer on the road if you do routine maintenance on it. Regarding the protection of your vehicle, kindly refer to the following recommendations.

After 1,000 kilometers or two months, whichever comes first, new vehicles are required to have their first inspection and service at a service center.

After that, it is recommended to make an appointment at the service center every 3,000 kilometers or every six months (whichever comes first) for a routine inspection and maintenance check.

TECHNICAL PARAMETERS

NAME	ITEM	SPECIFICATION
Basic Parameters	Dimension (L*W*H)	1937 x 725 x 1233 mm
	Wheelbase	1350 mm
	Weight	95 kg
	Storage capacity	One full helmet (about 25L)
	Tyre Specifications	Front & Rear: 120/70-14
	Brake system	Front & Rear Disc Brake + CBS
	Slope hill-ability	13°
Battery system	Battery capacity	60V 68Ah
	Cell type	LG C 21700
	Standard Discharging Current	8 A
	Singal battery weight	13 kg
Electrical system	Headlamp	LED
	Indicator light	LED
	Taillight	LED
	Speedometer	7"VA negative color screen
Power system	Motor type	Wheel motor
	Max. Motor Continuous Power	4310 W
	Maximum Speed	80 km/h
	Controller Maximum Current	80 A

ELECTRICAL SCHEMATIC

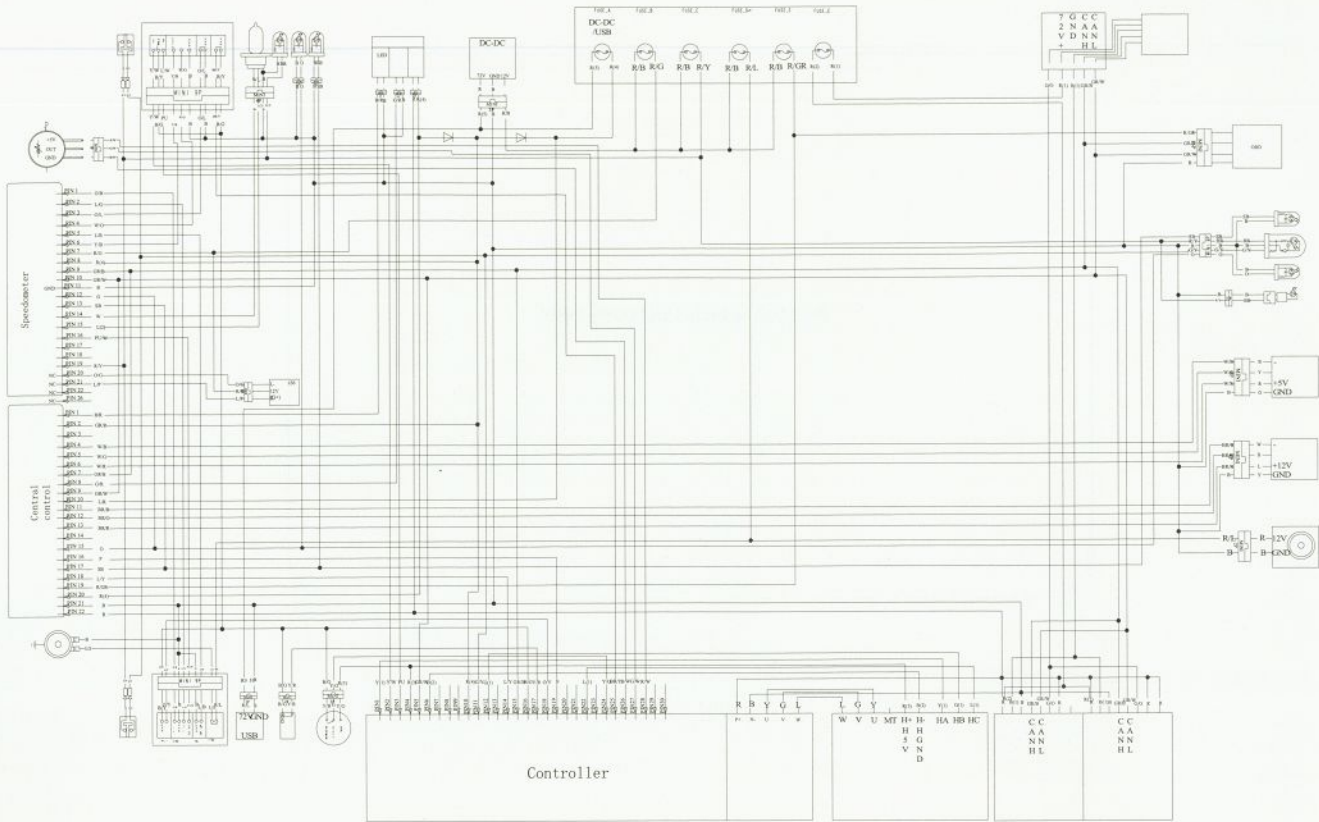

Post this vehicle CBD code here!

For more information on how to register your vehicle, go to the next page.



www.lvmoto.com