

Dahua HDCVI Standalone DVR User's Manual

V2.3.5

Table of Contents

1	FEATURES AND SPECIFICATIONS.....	1
1.1	Overview.....	1
1.2	Features.....	1
1.3	Specifications	2
1.3.1	HCVR5104C Series	2
1.3.2	HCVR51XXC-V2 Series.....	6
1.3.3	HCVR7104C-V2 Series.....	8
1.3.4	HCVR410XC-S2 Series	9
1.3.5	HCVR510XC-S2 Series	11
1.3.6	HCVR7104C-S2 Series.....	12
1.3.7	HCVR2108C-S2 Series.....	13
1.3.8	HCVR410XC-S3 Series	15
1.3.9	HCVR510XC-S3 Series	16
1.3.10	HCVR7104C-S3 Series	18
1.3.11	HCVR51XXH Series	19
1.3.12	HCVR51XXH-V2 Series.....	23
1.3.13	HCVR51XXHC Series.....	25
1.3.14	HCVR51XXHC-V2 Series.....	29
1.3.15	HCVR51XXHE Series.....	30
1.3.16	HCVR51HE-V2 Series	34
1.3.17	HCVR71XXH-V2 Series.....	36
1.3.18	HCVR71XXHC-V2 Series.....	37
1.3.19	HCVR71XHE-V2 Series.....	38
1.3.20	HCVR41XXHE-S2 Series	40
1.3.21	HCVR51XXH-S2 Series.....	41
1.3.22	HCVR51XXHE-S2 Series	42
1.3.23	HCVR710XH-S2 Series	44
1.3.24	HCVR710XHE-S2 Series	45
1.3.25	HCVR41XXHE-S3 Series	47
1.3.26	HCVR51XXH-S3 Series.....	48
1.3.27	HCVR51XXHE-S3 Series	50
1.3.28	HCVR71XXHE-S3 Series	52
1.3.29	HCVR71XXH-S3 Series.....	54
1.3.30	HCVR41XXHS-S2 Series	56
1.3.31	HCVR21XXHS-S2 Series	57
1.3.32	HCVR21XXHS-S3 Series	59
1.3.33	HCVR41XXHS-S3 Series	60
1.3.34	HCVR51XXHS-S3 Series	62
1.3.35	HCVR71XXHS-S3 Series	64

1.3.36	HCVR52XXA-V2 Series.....	65
1.3.37	HCVR72XXA-V2 Series.....	67
1.3.38	HCVR42XXA-S2/4216AN-S2 Series.....	68
1.3.39	HCVR4224/4232AN-S2 Series.....	69
1.3.40	HCVR52XXA-S2/HCVR5216AN-S2 Series.....	71
1.3.41	HCVR720XA-S2 Series.....	72
1.3.42	HCVR42XXA-S3 Series.....	74
1.3.43	HCVR42XXAN-S3 Series.....	76
1.3.44	HCVR52XXA-S3 Series.....	78
1.3.45	HCVR52XXAN-S3 Series.....	80
1.3.46	HCVR72XXA-S3/HCVR7216AN-S3 Series.....	81
1.3.47	HCVR52XXL-V2 Series.....	84
1.3.48	HCVR54XXL-V2 Series.....	85
1.3.49	HCVR4224/32L-S2 Series.....	87
1.3.50	HCVR44XXL-S2 Series.....	88
1.3.51	HCVR48XXS-S2 Series.....	91
1.3.52	HCVR58XXS-V2 Series.....	94
1.3.53	HCVR71XXH-4M Series.....	95
1.3.54	HCVR72XXAN-4M Series.....	97
1.3.55	XVR410XC Series.....	99
1.3.56	XVR510XC Series.....	100
1.3.57	XVR7104C Series.....	102
1.3.58	XVR41XXHE Series.....	103
1.3.59	XVR51XXH Series.....	105
1.3.60	XVR51XXHE Series.....	107
1.3.61	XVR71XXHE Series.....	109
1.3.62	XVR71XXH Series.....	111
1.3.63	XVR21XXHS Series.....	113
1.3.64	XVR41XXHS Series.....	115
1.3.65	XVR51XXHS Series.....	116
1.3.66	XVR7104HS Series.....	118
1.3.67	XVR42XXA Series.....	120
1.3.68	XVR42XXAN Series.....	122
1.3.69	XVR52XXA Series.....	126
1.3.70	XVR52XXAN Series.....	128
1.3.71	XVR72XXA Series.....	132
1.3.72	XVR72XXAN Series.....	134
1.3.73	XVR54XXL Series.....	136
1.3.74	XVR74XXL Series.....	138
1.3.75	XVR58XXS Series.....	140
1.3.76	XVR78XXS Series.....	142
1.3.77	HCVR710XH-4K Series.....	144
1.3.78	HCVR720XAN-4K Series.....	146
1.3.79	XVR5104C-4M/XVR5104HS-4M/XVR5104H-4M Series.....	148

1.3.80	XVR5204AN-4M Series	149
1.3.81	XVR5108HS-4KL/XVR5108H-4KL/XVR5116H-4KL Series	151
1.3.82	XVR5208AN-4KL/XVR5216AN-4KL Series	153
1.3.83	XVR7104HE-4KL/XVR7108HE-4KL/XVR7116HE-4KL Series	155
1.3.84	XVR7204A-4KL/XVR7208A-4KL/XVR7216A-4KL Series	157
1.3.85	XVR7208A-4K Series	159
1.3.86	XVR410XC-S2 Series.....	160
1.3.87	XVR510XC-S2 Series.....	162
1.3.88	XVR41XXHS-S2 Series.....	163
1.3.89	XVR51XXHS-S2 Series.....	165
1.3.90	XVR51XXH-S2 Series	167
1.3.91	XVR51XXHE-S2 Series.....	169
1.3.92	XVR42XXA-S2 Series.....	172
1.3.93	XVR42XXAN-S2 Series.....	174
1.3.94	XVR52XXA-S2 Series.....	176
1.3.95	XVR52XXAN-S2 Series.....	180
1.3.96	XVR5108H-4KL-8P Series	184
1.3.97	XVR5208AN-4KL-8P/XVR5216AN-4KL-16P Series	185
1.3.98	XVR1A04/XVR1A08 Series	187

2 OVERVIEW AND CONTROLS..... 190

2.1 Front Panel..... 190

2.1.1	HCVR5104C/HCVR51XXC-V2/HCVR71XXC-V2/ HCVR4104/4108C-S2/ HCVR5104 5108C-S2/ HCVR7104C-S2/ HCVR2108C-S2/ HCVR410XC-S3/HCVR510XC-S3/7104C-S3/ XVR410XC/XVR510XC/7104C/XVR51XXC-4M/ XVR41XXC-S2/ XVR51XXC-S2 Series 190	
2.1.2	HCVR51XXH/HCVR51XXHE/ HCVR51XXH-V2 / HCVR51XXHE-V2/HCVR71XXH-V2 / HCVR71XXHE-V2 Series	190
2.1.3	HCVR51XXHC/ HCVR51XXHC-V2/ HCVR71XXHC-V2 Series.....	192
2.1.4	HCVR41XXHE-S2/ HCVR51XXH-S2/ HCVR51XXHE-S2/ HCVR710XH-S2/ HCVR710XHE-S2/ HCVR41XXHE-S3/HCVR51XXH-S3/HCVR51XXHE-S3/HCVR71XXH-S3/HCVR71XXHE-S3 /HCVR41XXHS-S2/ HCVR21XXHS-S2/ HCVR21XXHS-S3/HCVR41XXHS-S3/51XXHS-S3/7104HS-S3/ XVR41XXHE/XVR51H/XVR51XXHE/XVR71XXH/XVR71XXHE /HCVR41XXHS-S2/ HCVR21XXHS-S2/ XVR21XXHS/XVR41XXHS/XVR51XXHS/XVR7104HS/HCVR71XX-4M/HCVR710XH-4K/X VR51XXHS-4M/XVR51XXHS-4KL/XVR51XXH-4M/ XVR51XXH-4KL/ XVR71XXHE-4KL/XVR51XXH-S2/XVR51HE-S2/ XVR41XXHS-S2/ XVR51XXHS-S2/XVR5108H-4KL-8P Series.....	192
2.1.5	HCVR52XXA-V2/ HCVR72XXA-V2 Series.....	193

2.1.6	HCVR42XXA-S2/ HCVR42XXAN-S2/ HCVR52XXA-S2/ HCVR5216AN-S2/HCVR720XA-S2/ HCVR42XXA-S3/HCVR42XXAN-S3/HCVR52XXA-S3/HCVR52XXAN-S3/HCVR72XXA-S3 /HCVR7216AN-S3/XVR42XXA/XVR42XXAN/XVR52XXA/XVR52XXAN/XVR72XXA/XVR7 216AN/HCVR 72XXAN-4M/HCVR720XAN-4K/XVR52XXAN-4M/ XVR52XXAN-4KL/XVR72XXA-4KL/XVR72XXA-4K/ XVR42XXA-S2/ XVR42XXAN-S2/ XVR52XXA-S2/ XVR52XXAN-S2/XVR5208AN-4KL-8P/XVR5216AN-4KL-16P Series ..	195
2.1.7	HCVR42XXL-S2/HCVR44XXL-S2/ XVR54XXL/ XVR74XXL Series	195
2.1.8	HCVR52XXL-V2/ HCVR54XXL-V2 Series.....	196
2.1.9	HCVR58XXS-V2 Series	198
2.1.10	HCVR48XXS-S2/ XVR58XXS/ XVR78XXS Series	200
2.1.11	XVR1A04/XVR1A08 Series	200
2.2	Rear Panel	201
2.2.1	HCVR5104C Series	201
2.2.2	HCVR5104C-V2/HCVR5108C-V2 Series	202
2.2.3	HCVR7104C-V2 Series.....	203
2.2.4	HCVR4104/HCVR4108C-S2/HCVR2108C-S2 Series.....	204
2.2.5	HCVR5104/5108C-S2 Series.....	205
2.2.6	HCVR7104C-S2 Series.....	207
2.2.7	HCVR410XC-S3/HCVR510XC-S3/7104C-S3/XVR410XC/XVR510XC/7104C/XVR 5104C-4M/ XVR41XXC-S2/ XVR51XXC-S2 Series	208
2.2.8	HCVR5104H/HCVR5108H Series	209
2.2.9	HCVR5104H-V2/HCVR5108H-V2/HCVR5116H-V2 Series	210
2.2.10	HCVR5104HC/HCVR5108HC Series.....	212
2.2.11	HCVR5104HC-V2/HCVR5108HC-V2/HCVR5116HC-V2 Series	214
2.2.12	HCVR5104HE/HCVR5108HE Series	215
2.2.13	HCVR5104HE-V2/HCVR5108HE-V2/HCVR5116HE-V2 Series	217
2.2.14	HCVR7104H-V2/HCVR7108H-V2 Series.....	219
2.2.15	HCVR7104HC-V2/HCVR7108HC-V2 Series.....	220
2.2.16	HCVR7104HE-V2/HCVR7108HE-V2 Series.....	222
2.2.17	HCVR4104/4108/4116HE-S2 Series.....	223
2.2.18	HCVR5104/5108/5116H-S2 Series	225
2.2.19	HCVR5104/5108/5116HE-S2 Series.....	227
2.2.20	HCVR7104/7108H-S2 Series	229
2.2.21	HCVR7104/7108HE-S2 Series.....	231
2.2.22	HCVR41XXHE-S3/HCVR51XXH-S3/HCVR71XXH-S3/HCVR71XXHE-S3 /XVR41XXHE/XVR51XXH/XVR51XXHE/XVR71XXH/XVR71XXHE/ XVR51XXH-4M/ XVR51XXH-4KL/XVR71XXHE-4KL/ XVR51XXH-S2/ XVR51XXHE-S2 Series	233
2.2.23	HCVR41XXHS-S2/ HCVR2108HS-S2/ HCVR2116HS-S2 Series	235
2.2.24	HCVR21XXHS-S3/HCVR41XXHS-S3/HCVR51XXHS-S3/HCVR7104HS-S3 /XVR21XXHS/XVR41XXHS/XVR51XXHS/XVR7104HS/XVR51XXHS-4M/XVR51XXHS-4K L/ XVR41XXHS-S2/ XVR51XXHS-S2 Series	237
2.2.25	HCVR52XXA-V2/ HCVR72XXA-V2 Series.....	239

2.2.26	HCVR42XXA-S2/ HCVR4216AN-S2 Series.....	240
2.2.27	HCVR4224/HCVR4232AN-S2 Series.....	242
2.2.28	HCVR52XXA-S2/ HCVR5216AN-S2 Series.....	243
2.2.29	HCVR720XA-S2 Series	245
2.2.30	HCVR42XXA-S3/HCVR42XXAN-S3/HCVR52XXA-S3/HCVR52XXAN-S3/HCVR 72XXA-S3/HCVR7216AN-S3/XVR42XXA/XVR42XXAN/XVR52XXA/XVR52XXAN/XVR72X XA/XVR7216AN/ XVR52XXAN-4M/XVR52XXAN-4K/XVR72XXA-4K/XVR72XXA-4K/ XVR42XXA-S2/ XVR42XXAN-S2/ XVR52XXA-S2/ XVR52XXAN-S2 Series.....	247
2.2.31	HCVR52XXL-V2/ HCVR54XXL-V2/HCVR44L-S2 Series	249
2.2.32	HCVR42XXL-S2 Series	253
2.2.33	HCVR58XXS-V2/HCVR48XXS-S2 Series.....	254
2.2.34	HCVR71XXH-4M Series	258
2.2.35	HCVR72XXAN-4M Series	259
2.2.36	XVR54XXL/ XVR74XXL Series	260
2.2.37	XVR58XXS/ XVR78XXS Series	268
2.2.38	HCR710XH-4K Series	273
2.2.39	HCVR720XAN-4K Series	275
2.2.40	XVR5108H-4KL-8P Series	276
2.2.41	XVR5208AN-4KL-8P/XVR5216AN-4KL-16P Series	278
2.2.42	XVR1A04/XVR1A08 Series	281
2.3	Connection Sample	282
2.3.1	Smart Box Series	282
2.3.2	Smart 1U Series	282
2.3.3	Compact 1U/Cooper 1U Series.....	283
2.3.4	Mini 1U Series	284
2.3.5	1U Series.....	284
2.3.6	1.5U Series.....	285
2.3.7	2U Series.....	286
2.4	Remote Control.....	287
2.5	Mouse Control.....	289
2.6	Virtual Keyboard & Front Panel	291
2.6.1	Virtual Keyboard.....	291
2.6.2	Front Panel.....	291
3	INSTALLATION AND CONNECTIONS	292
3.1	Check Unpacked DVR	292
3.2	About Front Panel and Rear Panel	292
3.3	HDD Installation	292

3.3.1	Smart Box Series	292
3.3.2	Smart 1U Series	293
3.3.3	Compact 1U and Mini 1U Series	294
3.3.4	The 1U Series	295
3.3.5	The 1.5U Series	296
3.3.6	The 2U Series	296
3.3.7	Cooper 1U Series	297
3.3.8	Rack Installation	298
3.4	Connecting Power Supply	298
3.5	Connecting Video Input and Output Devices	298
3.5.1	Connecting Video Input	298
3.5.2	Connecting Video Output	299
3.6	Connecting Audio Input & Output, Bidirectional Audio	299
3.6.1	Audio Input	299
3.6.2	Audio Output	299
3.7	Alarm Input and Output Connection	299
3.7.1	Alarm Input and Output Details	300
3.7.2	Alarm Input Port	301
3.7.3	Alarm Output Port	302
3.8	RS485	303
3.9	Other Interfaces	303
4	OVERVIEW OF NAVIGATION AND CONTROLS	304
4.1	Initial Settings	304
4.1.1	Boot up	304
4.1.2	Device Initialization	304
4.1.3	Reset Password	307
4.1.4	Quick Settings	313
4.2	Preview	343
4.2.1	Preview Window	343
4.2.2	Preview Control	344
4.3	Right-Click Menu	347
4.3.1	Window Switch	348
4.3.2	Previous Screen/Next Screen	349
4.3.3	PTZ Control	349
4.3.4	Auto Focus	354
4.3.5	Color	355

4.3.6	Display.....	357
4.3.7	Face Search	357
4.3.8	Search	357
4.3.9	Record Control	358
4.3.10	Alarm Output.....	358
4.3.11	Remote Device	358
4.3.12	Video Matrix	358
4.3.13	Main menu	358
4.4	Navigation Bar	358
4.4.1	Main Menu.....	358
4.4.2	Output Screen	358
4.4.3	Previous/Next Screen	358
4.4.4	Tour	358
4.4.5	Favorites.....	358
4.4.6	Channel	359
4.4.7	PTZ.....	359
4.4.8	Color	359
4.4.9	Search	359
4.4.10	Alarm Status	359
4.4.11	Channel Info.....	359
4.4.12	Registration	360
4.4.13	Network.....	360
4.4.14	HDD Manager	360
4.4.15	USB Manager	360
4.5	USB Device Auto Pop-up.....	360
4.6	Main Menu	361
4.7	Operation.....	362
4.7.1	Search	362
4.7.2	Human Face Search	371
4.7.3	Backup	372
4.7.4	Shut Down.....	374
4.8	Information	374
4.8.1	System Info	374
4.8.2	Event	382
4.8.3	Network	382
4.8.4	Log	384
4.9	Setting.....	386
4.9.1	Camera.....	386
4.9.2	Network	400
4.9.3	Event	418

4.9.4	Storage	449
4.9.5	System	470
5	WEB OPERATION	504
5.1	Network Connection.....	504
5.2	Device Initialization	504
5.3	Login	507
5.4	Reset Password.....	508
5.5	LAN Mode.....	510
5.6	Real-time Monitor	513
5.6.1	Fisheye de-warp.....	513
5.7	PTZ.....	515
5.8	Image/Relay-out.....	516
5.8.1	Image	516
5.8.2	Relay output	517
5.9	WAN Login	517
5.10	Setup.....	518
5.10.1	Camera	518
5.10.2	Network.....	533
5.10.3	Event.....	551
5.10.4	Storage	577
5.10.5	Setting.....	585
5.11	Information	616
5.11.1	Version.....	616
5.11.2	Log	616
5.11.3	Online User	617
5.11.4	HDD	617
5.12	Playback	618
5.12.1	Search Record.....	618
5.12.2	Fisheye Playback De-Warp	619
5.12.3	File List.....	620
5.12.4	Playback	620
5.12.5	Download	621
5.12.6	Load more.....	621

5.13	Face Search.....	624
5.14	Alarm.....	625
5.15	Log out.....	626
5.16	Un-install Web Control.....	626
6	SMARTPSS.....	627
7	FAQ.....	628
	APPENDIX A HDD CAPACITY CALCULATION.....	636
	APPENDIX B COMPATIBLE BACKUP DEVICES.....	638
	Appendix B-1 Compatible USB list.....	638
	Appendix B-2 Compatible SD Card list.....	639
	Appendix B-3 Compatible Portable HDD list.....	639
	Appendix B-4 Compatible USB DVD List.....	639
	Appendix B-5 Compatible SATA DVD List.....	639
	Appendix B-6 Compatible SATA HDD List.....	640
	APPENDIX C COMPATIBLE CD/DVD BURNER LIST.....	645
	APPENDIX D COMPATIBLE DISPLAYER LIST.....	646
	APPENDIX E COMPATIBLE SWITCHER.....	647
	APPENDIX F COMPATIBLE WIRELESS MOUSE LIST.....	648
	APPENDIX G EARTHING.....	649

Welcome

Thank you for purchasing our HDCVI DVR!

This user's manual is designed to be a reference tool for the installation and operation of your system.

Here you can find information about this series standalone DVR features and functions, as well as a detailed menu tree.

Before installation and operation please read the following safeguards and warnings carefully!

Cybersecurity Recommendations

Cybersecurity Recommendations

Mandatory actions to be taken towards cybersecurity

1. Change Passwords and Use Strong Passwords:

The number one reason systems get “hacked” is due to having weak or default passwords. It is recommended to change default passwords immediately and choose a strong password whenever possible. A strong password should be made up of at least 8 characters and a combination of special characters, numbers, and upper and lower case letters.

2. Update Firmware

As is standard procedure in the tech-industry, we recommend keeping NVR, DVR, and IP camera firmware up-to-date to ensure the system is current with the latest security patches and fixes.

“Nice to have” recommendations to improve your network security

1. Change Passwords Regularly

Regularly change the credentials to your devices to help ensure that only authorized users are able to access the system.

2. Change Default HTTP and TCP Ports:

- Change default HTTP and TCP ports for systems. These are the two ports used to communicate and to view video feeds remotely.
- These ports can be changed to any set of numbers between 1025-65535. Avoiding the default ports reduces the risk of outsiders being able to guess which ports you are using.

3. Enable HTTPS/SSL:

Set up an SSL Certificate to enable HTTPS. This will encrypt all communication between your devices and recorder.

4. Enable IP Filter:

Enabling your IP filter will prevent everyone, except those with specified IP addresses, from accessing the system.

5. Change ONVIF Password:

On older IP Camera firmware, the ONVIF password does not change when you change the system's credentials. You will need to either update the camera's firmware to the latest revision or manually change the ONVIF password.

6. Forward Only Ports You Need:

- Only forward the HTTP and TCP ports that you need to use. Do not forward a huge range of numbers to the device. Do not DMZ the device's IP address.
- You do not need to forward any ports for individual cameras if they are all connected to a recorder on site; just the NVR is needed.

7. Disable Auto-Login on SmartPSS:

Those using SmartPSS to view their system and on a computer that is used by multiple people should disable auto-login. This adds a layer of security to prevent users without the appropriate credentials from accessing the system.

8. Use a Different Username and Password for SmartPSS:

In the event that your social media, bank, email, etc. account is compromised, you would not want someone collecting those passwords and trying them out on your video surveillance system. Using a different username and password for your security system will make it more difficult for someone to guess their way into your system.

9. Limit Features of Guest Accounts:

If your system is set up for multiple users, ensure that each user only has rights to features and functions they need to use to perform their job.

10. UPnP:

- UPnP will automatically try to forward ports in your router or modem. Normally this would be a good thing. However, if your system automatically forwards the ports and you leave the credentials defaulted, you may end up with unwanted visitors.
- If you manually forwarded the HTTP and TCP ports in your router/modem, this feature should be turned off regardless. Disabling UPnP is recommended when the function is not used in real applications.

11. SNMP:

Disable SNMP if you are not using it. If you are using SNMP, you should do so only temporarily, for tracing and testing purposes only.

12. Multicast:

Multicast is used to share video streams between two recorders. Currently there are no known issues involving Multicast, but if you are not using this feature, deactivation can enhance your network security.

13. Check the Log:

If you suspect that someone has gained unauthorized access to your system, you can check the system log. The system log will show you which IP addresses were used to login to your system and what was accessed.

14. Physically Lock Down the Device:

Ideally, you want to prevent any unauthorized physical access to your system. The best way to achieve this is to install the recorder in a lockbox, locking server rack, or in a room that is behind a lock and key.

15. Connect IP Cameras to the PoE Ports on the Back of an NVR:

Cameras connected to the PoE ports on the back of an NVR are isolated from the outside world and cannot be accessed directly.

16. Isolate NVR and IP Camera Network

The network your NVR and IP camera resides on should not be the same network as your public computer network. This will prevent any visitors or unwanted guests from getting access to the same network the security system needs in order to function properly.

Regulatory Information

FCC Information



Changes or modifications not expressly approved by the party responsible for compliance could void the user's authority to operate the equipment.

FCC conditions:

This device complies with part 15 of the FCC Rules. Operation is subject to the following two conditions:

- This device may not cause harmful interference.
- This device must accept any interference received, including interference that may cause undesired operation.

FCC compliance:

This equipment has been tested and found to comply with the limits for a digital device, pursuant to part 15 of the FCC Rules. This equipment generate, uses and can radiate radio frequency energy and, if not installed and used in accordance with the guide, may cause harmful interference to radio communication.

- For class A device, these limits are designed to provide reasonable protection against harmful interference in a commercial environment. Operation of this equipment in a residential area is likely to cause harmful interference in which case the user will be required to correct the interference at his own expense.
- For class B device, these limits are designed to provide reasonable protection against harmful interference in a residential installation. However, there is no guarantee that interference will not occur in a particular installation. If this equipment does cause harmful interference to radio or television reception, which can be determined by turning the equipment off and on, the user is encouraged to try to correct the interference by one or more of the following measures:
 - Reorient or relocate the receiving antenna.
 - Increase the separation between the equipment and receiver.
 - Connect the equipment into an outlet on a circuit different from that to which the receiver is connected.
 - Consult the dealer or an experienced radio/TV technician for help.

Important Safeguards and Warnings

1 . Electrical safety

All installation and operation here should conform to your local electrical safety codes.

The product must be grounded to reduce the risk of electric shock.

An apparatus with CLASS I construction shall be connected to a MAINS socket outlet with a protective earthing connection.

We assume no liability or responsibility for all the fires or electrical shock caused by improper handling or installation.

2 . Transportation security

Heavy stress, violent vibration or water splash are not allowed during transportation, storage and installation.

3 . Installation

Keep upwards. Handle with care.

Do not apply power to the DVR before completing installation.

Do not place objects on the DVR.

4 . Qualified engineers needed

All the examination and repair work should be done by the qualified service engineers.

We are not liable for any problems caused by unauthorized modifications or attempted repair.

5 . Environment

The DVR should be installed in a cool, dry place away from direct sunlight, inflammable, explosive substances and etc.

6. Accessories

Be sure to use all the accessories recommended by manufacturer.

Before installation, please open the package and check all the components are included.

Contact your local retailer ASAP if something is broken in your package.

7. Lithium battery









Improper battery use may result in fire, explosion, or personal injury!

When replace the battery, please make sure you are using the same model!

RISK OF EXPLOSION IF BATTERY IS REPLACED BY AN INCORRECT TYPE.

DISPOSE OF USED BATTERIES ACCORDING TO THE INSTRUCTIONS.

Safety Instruction

Icon	Note
 DANGER	Indicates a high potential hazard which, if not avoided, will result in death or serious injury.
 WARNING	Indicates a medium or low potential hazard which, if not avoided, could result in slight or moderate injury.
 CAUTION	Indicates a potential risk which, if not avoided, could result in property damage, data loss, lower performance, or unpredictable result.
 Anti-static	Indicates it is the static sensitive device.
 Electric shock risk	Indicates presence of dangerous high voltage. There is a risk of electric shock to persons.
 High power laser radiation risk	Indicates presence of high power laser radiation.
 Tips	It is intended to help you to fix a problem or save your time.
 Note	Provides additional information to emphasize or supplement important points of the main text.

Revision History

No.	Version	Revision Content	Release Time
1	V2.3.4	Adds cooper 1U series XVR1A04 and XVR1A08.	May, 2018
2	V2.3.5	Adds new features to comply with GDPR requirements	June, 2018

Privacy Protection Notice

As the device user or data controller, you might collect personal data of others' such as face, fingerprints, car plate number, Email address, phone number, GPS and so on. You need to be in compliance with the local privacy protection laws and regulations to protect the legitimate rights and interests of other people by implementing measures include but not limited to: providing clear and visible identification to inform data subject the existence of surveillance area and

providing related contact.

About the Manual

- The Manual is for reference only. If there is inconsistency between the Manual and the actual product, the actual product shall prevail.
- We are not liable for any loss caused by the operations that do not comply with the Manual.
- The Manual would be updated according to the latest laws and regulations of related regions. For detailed information, see the paper User's Manual, CD-ROM, QR code or our official website. If there is inconsistency between paper User's Manual and the electronic version, the electronic version shall prevail.
- All the designs and software are subject to change without prior written notice. The product updates might cause some differences between the actual product and the Manual. Please contact the customer service for the latest program and supplementary documentation.
- There still might be deviation in technical data, functions and operations description, or errors in print. If there is any doubt or dispute, please refer to our final explanation.
- Upgrade the reader software or try other mainstream reader software if the Guide (in PDF format) cannot be opened.
- All trademarks, registered trademarks and the company names in the Manual are the properties of their respective owners.
- Please visit our website, contact the supplier or customer service if there is any problem occurred when using the device.
- If there is any uncertainty or controversy, please refer to our final explanation.

1 FEATURES AND SPECIFICATIONS

1.1 Overview

The standalone series DVR is an excellent digital monitor product designed for security field.

It adopts embedded Linux OS to maintain reliable operation. Popular H.264 compression algorithm and G.711 audio compression technology realize high quality, low bit stream. Unique frame by frame play function is suitable for detailed analysis. It has various functions such as record, playback, monitor at the same time and can guarantee audio video synchronization. This series product has advanced technology and strong network data transmission function.

This series device adopts embedded design to achieve high security and reliability. It can work in the local end, and at the same time, when connecting it to the professional surveillance software (PSS), it can connect to the security network to realize strong network and remote monitor function.

This series product can be widely used in various areas such as banking, telecommunication, electric power, interrogation, transportation, intelligent resident zone, factory, warehouse, resources, and water conservancy.

1.2 Features

This series product has the following features:

- **Real-time surveillance**

Support VGA port and HDMI port. Realize the surveillance through displayer. Support HDMI, VGA, and TV output at the same time.

- **Storage function**

Special data format to guarantee data security and can remove the risk of the vicious data modification. Support digital watermark.

- **Compression format**

Support multiple-channel audio and video. An independent hardware decodes the audio and video signal from each channel to maintain video and audio synchronization.

- **Backup function**

Support backup operation via USB port (such as U disk, portable HDD, burner)
Client-end user can download the file to local HDD to backup via network.

- **Record & playback function**

Support each channel real-time record independently, and at the same time it can support search, forward play, network monitor, record search, download and etc.

Support various playback modes: slow play, fast play, backward play and frame by frame play.

Support time title overlay so that you can view event accurate occurred time

Support customized zoom function during the preview.

- **Network operation**

Support network remote real-time monitor, remote record search and remote PTZ control.

- **Alarm activation function**

Several relay alarm outputs to realize alarm activation and on-site light control.

The alarm input port and output has the protection circuit to guarantee device safety.

- **Communication port**

RS485 port can realize alarm input and PTZ control.

RS232 port can connect to keyboard to realize central control, and can also connect to PC COM to upgrade system and realize maintenance, and matrix control.

Standard Ethernet port can realize network access function.

The dual-network port has the multiple-access, fault-tolerance, load-balance setup mode.

- **PTZ control**

Support PTZ decoder via RS485.

- **Intelligent operation**

Mouse operation function

In the menu, support copy and paste setup function

- **UPnP (Universal Plug and Play)**

Establish mapping connection between LAN and WAN via UPnP protocol.

Slight function differences may be found due to different series.

1.3 Specifications

1.3.1 HCVR5104C Series

	Parameter	HCVR5104C
System	Main Processor	High-performance industrial embedded micro controller
	OS	Embedded LINUX
	System Resources	Multiplex operations: Multiple-channel record, multiple-channel playback and network operation simultaneously
	Interface	User-friendly graphical user interface

	Input Devices	USB mouse	
	Input Method	Arabic number, English character, donation and extension Chinese (optional)	
	Shortcut Function	Copy/paste operation, USB mouse right-key shortcut menu, double click USB mouse to switch screen.	
Compression Standard	Video Compression	H.264	
	Audio Compression	G711A, G711U, PCM	
Video monitor	Video Input	4-CH composite video input: (NTSC/PAL) BNC (1.0V _{P-P} , 75Ω)	
	Video Output	1-ch VGA output. 1-ch HDMI output. Support VGA/HDMI video output at the same time.	
	Video Standard	Support PAL/NTSC.	
	Record Speed	Real-time Mode: PAL 1f/s to 25f/s per channel and NTSC 1f/s to 30f/s per channel	
	Video Partition	1/4 windows(Optional)	
	Monitor Touring	Support monitor tour functions such as motion detection, and schedule auto control.	
	Resolution (PAL/NTSC)		PAL/NTSC Real-time monitor: 720P 1280*720
			Playback: All-ch: 720P 1280*720, 960H 960 x576/960x480, D1 704x576/704x480, HD1 352x576/352x480, 2CIF 704x288/704x240, CIF 352x288/ 352x240 , QCIF 176x144/176x120
			Support dual streams: extra stream resolution CIF 352x288/ 352x240, QCIF 176x144/176x120.
	Image Quality	6-level image quality (Adjustable)	
	Privacy mask	Support one privacy mask of user-defined size in full screen. Support max 4 zones.	
	Image Information	Channel information, time information and privacy mask zone.	
TV Adjust	Adjust TV output zone suitable to anamorphic video.		

	Channel Lock	Cover secret channel with black screen though system is encoding normally. Screen-lock function to prevent unauthorized user seeing secret video.
	Channel Information	Channel name, recording status, screen lock status, video loss status and motion detection status are shown on the bottom left of display screen.
	Color Configuration	Hue, brightness, contrast, saturation and gain setup for each channel.
Audio	Audio Input	N/A
	Audio Output	N/A
	Bidirectional Audio	N/A
Hard disk	Hard Disk	1 built-in SATA port. Support 1 HDD.
	One HDD Space	4T
	Hard Disk Occupation	Audio:PCM 28.8MByte/h Video:56-900MByte/h
Record and playback	Recording Mode	Manual recording, motion detection recording, schedule recording and alarm recording Priority: Manual recording> alarm recording>motion detection recording>schedule recording.
	Storage Mode	Support channel record quota setup
	Recording Length	1 to 120 minutes single record duration (Default setup is 60 minutes)
	Playback Repeat Way	When hard disk is full, system can overwrite previous video file.
	Record Search	Various search engines such as time, type and channel.
	Playback Mode	Various fast play, slow play speeds, manual frame by frame playback and reverse play mode.
	Various File Switch Ways	Can switch to previous or next file or any file in current play list. Can switch to file on other channel of the same time. (If there is a file) Support file continuous play, when a file is end system auto plays the next file in the current channel
	Playback Way	Support mark playback
	Multi-channel Playback	There is 1/4-channel playback mode.
	Window Zoom	Switch between self-adaptive screen/full screen when playback

	Partial Enlargement	When in one-window full-screen playback mode, you can select any zone to activate partial enlargement function.
Backup function	Backup Mode	HDD backup
		Support peripheral USB backup device. (Flash disk, portable disk and etc.)
		Support peripheral USB burner.
		Support network download and save
Network Function	Network control	View monitor channel remotely.
		DVR configuration through client-end and web browser
		Upgrade via client or browser to realize remote maintenance.
		View alarm information such as motion detection and video loss via client.
		Support network PTZ lens control
		File download backup and playback
		Multiple devices share information via corresponding software such as professional surveillance software (PSS)
		Duplex transparent COM
		Network alarm input and output
		Zero-channel encoding
		Bidirectional audio.
Motion Detection and Alarm	Motion Detection	Zone setup: support 396((PAL 22×18, NTSC 22×15)) detection zones. Various sensitivity levels. Alarm can activate record or external alarm or screen message prompt.
	Video Loss	Alarm can activate screen message prompt.
	External Alarm	N/A
	Manual Alarm Control	N/A
	Alarm Input	N/A
	Alarm Output	N/A
	Alarm Relay	N/A
Interface	USB Interface	2 USB 2.0 port.
	Network connection	1 RJ45 10M/100M self-adaptable Ethernet port
	RS485	N/A
	RS232	N/A
System Information	Hard Disk Information	Display HDD current status

	Data Stream Statistics	Data stream statistics for each channel (in wave mode)
	Log statistics	Backup to 1024 log files. Support various search engines such as time and type.
	Version	Display version information: channel amount, system version and release date.
	On-line user	Display current on-line user
User Management	User Management	Multi-lever user management; various management modes Integrated management for local user, serial port user and network user. Configurable user power.
		Support user /group and its corresponding rights modification. No limit to the user or group amount.
	Password Authentication	Password modification Administrator can modify other user's password.
		Account lock strategy Five times login failure in thirty minutes may result in account lock.
Upgrade		Web browser, client-end and update tool.
Login, Logout and Shutdown		Password login protection to guarantee safety
		User-friendly interface when login. Provide the following options: Logout /shutdown/ restart.
		Right authentication when shut down to make sure only those proper people can turn off DVR
General Parameter	Power	DC 12V
	Power Consumption	≤15W (With adapter, no HDD)
	Working Temperature	-10℃~+55℃
	Working Humidity	10%—90%
	Air Pressure	86kpa—106kpa
	Dimension	SMART 1U case 270(W) x205 (D) x41mm(H)
	Weight	1.25KG(no HDD)
	Installation Mode	Desktop installation

1.3.2 HCVR51XXC-V2 Series

	Parameters	HCVR5104C-V2	HCVR5108C-V2
System	Main Processor	Industrial embedded micro controller	
	OS	Embedded LINUX	

	Parameters	HCVR5104C-V2	HCVR5108C-V2
Video Parameters	Video Encode Standard	H.264	
	Encode Resolution	720P/D1/HD1/2CIF/CIF/QCIF	
	Video Frame Rate	PAL:1~25f/s; NTSC:1~30f/s	
	Video Bit Rate	1536Kbps-4096Kbps, For 720P: default setup is 2Mbps,max supports 4Mbps	
	Bit Stream Type	Video stream/composite stream	
	Dual-Stream	Support	
Audio Parameters	Encode Standard	G.711A/G.711U/PCM	
	Audio Sampling Rate	8KHz,16Bit	
	Audio Bit Rate	64Kbps	
Video Port	Analog Video Input	4-channel,BNC port	8-channel,BNC port
	Network Video Input	N/A	
	Video Output	1-channel VGA output, 1-channel HDMI output (of the same video source), HDMI/ VGA video output at the same time.	
	Loop Output	N/A	
	Matrix Output	N/A	
Audio Port	Audio Input	N/A	
	Audio Output	N/A	
	Bidirectional Talk Input	N/A	
Record	Record Mode	Schedule record/manual record/MD record/Alarm record	
	Record Playback	Max 4-channel playback	Max 8-channel playback
	Backup Mode	HDD, burner, USB device, network backup	
Alarm	Alarm Input	N/A	
	Alarm Output	N/A	
HDD	HDD Port	1 SATA port,does not support eSATA port	
	One HDD Space	4T	
Communication Port	Network	1 RJ45 port, 100Mbps Ethernet port	
	Communication	N/A	
	USB	2 USB ports	
Others	Power	DC12V	
	Power	≤15W (With power adapter, no HDD)	

	Parameters	HCVR5104C-V2	HCVR5108C-V2
	Consumption		
	Working Temperature	-10°C ~ +55°C	
	Working Humidity	10%~90%	
	Dimensions	SMART 1U case,270mm (W) x205mm (D) x41mm (H)	
	Weight	1.25KG (No HDD)	
	Installation Mode	Desk	

1.3.3 HCVR7104C-V2 Series

	Parameters	HCVR7104C-V2
System	Main Processor	Industrial embedded micro controller
	OS	Embedded LINUX
Video Parameters	Video Encode Standard	H.264
	Encode Resolution	1080P /720P/D1/HD1/2CIF/CIF/QCIF
	Video Frame Rate	PAL:1~25f/s; NTSC:1~30f/s
	Video Bit Rate	2048Kbps-6144Kbps, For 1080P: default setup is 4Mbps,max supports 6Mbps
	Bit Stream Type	Video stream/composite stream
	Dual-Stream	Support
Audio Parameters	Encode Standard	G.711A/G.711U/PCM
	Audio Sampling Rate	8KHz,16Bit
	Audio Bit Rate	64Kbps
Video Port	Analog Video Input	4-channel,BNC port
	Network Video Input	N/A
	Video Output	1-channel VGA output, 1-channel HDMI output (of the same video source), HDMI/ VGA video output at the same time.
	Loop Output	N/A
	Matrix Output	N/A
Audio Port	Audio Input	N/A
	Audio Output	N/A
	Bidirectional	N/A

	Parameters	HCVR7104C-V2
	Talk Input	
Record	Record Mode	Schedule record/manual record/MD record/Alarm record
	Record Playback	Max 4-channel playback
	Backup Mode	HDD, burner, USB device, network backup
Alarm	Alarm Input	N/A
	Alarm Output	N/A
HDD	HDD Port	1 SATA port, does not support eSATA port
	One HDD Space	4T
Communication Port	Network	1 RJ45 port, 100Mbps Ethernet port
	Communication	N/A
	USB	2 USB ports
Others	Power	DC12V
	Power Consumption	≤20W (With power adapter, no HDD)
	Working Temperature	-10°C ~ +55°C
	Working Humidity	10%~90%
	Dimensions	SMART 1U case, 270mm (W) × 205mm (D) × 41mm (H)
	Weight	1.25KG (No HDD)
	Installation Mode	Desk

1.3.4 HCVR410XC-S2 Series

	Parameters	HCVR4104C-S2	HCVR4108C-S2	
System	Main Processor	Industrial embedded micro controller		
	OS	Embedded LINUX		
Video Parameters	Video Encode Standard	H.264		
	Encode Resolution	720P/960H/D1/HD1/ 2CIF/CIF/QCIF	720P(1~15fps)/960H/D1/ HD1/2CIF/CIF/QCIF	
	Video Frame Rate	HDCVI:1~25f/s (PAL) ; 1~30f/s (NTSC) CVBS:1~25f/s (PAL) ; 1~30f/s (NTSC)	HDCVI:1 ~ 15f/s (The 1 st channel supports 25/30f) CVBS:1~25f/s (PAL) ; 1~30f/s (NTSC)	
	Video Bit Rate	2048Kbps-4096Kbps, For 720P: default setup is 2Mbps, max supports 4Mbps. For 960H: default setup is 1Mbps, max supports 3Mbps.	1024Kbps-4096Kbps, For 720P: default setup is 1Mbps, max supports 4Mbps. For 960H: default setup is 1Mbps, max supports 3Mbps.	
	Bit Stream Type	Video stream/composite stream		

	Parameters	HCVR4104C-S2	HCVR4108C-S2
	Dual-Stream	Support	
Audio Parameters	Encode Standard	G.711A/G.711U/PCM	
	Audio Sampling Rate	8KHz,16Bit	
	Audio Bit Rate	64Kbps	
Video Port	Analog Video Input	4-channel,BNC port	8-channel,BNC port
	Network Video Input	Max 2-channel IPC connections (8M)	
	Video Output	1-channel VGA output, 1-channel HDMI output (of the same video source), HDMI/ VGA video output at the same time.	
	Loop Output	N/A	
	Matrix Output	N/A	
Audio Port	Audio Input	1-channel RCA port.	
	Audio Output	1-channel RCA port.	
	Bidirectional Talk Input	Reuse the audio input/output port.	
Record	Record Mode	Schedule record/manual record/MD record/Alarm record	
	Record Playback	Max 4-channel playback	Max 8-channel playback
	Backup Mode	HDD, burner, USB device, network backup	
Alarm	Alarm Input	N/A	
	Alarm Output	N/A	
HDD	HDD Port	1 SATA port,does not support eSATA port	
	One HDD Space	4T	
Communication Port	Network	1 RJ45 port, 100Mbps Ethernet port	
	Communication	N/A	
	USB	2 USB ports	
Others	Power	DC12V	
	Power Consumption	≤15W (With power adapter, no HDD)	
	Working Temperature	-10℃~+55℃	
	Working Humidity	10%~90%	
	Dimensions	SMART 1U case,270mm (W) x205mm (D) x41mm (H)	
	Weight	1.25KG (No HDD)	
	Installation Mode	Desk	

1.3.5 HCVR510XC-S2 Series

	Parameters	HCVR5104C-S2	HCVR5108C-S2
System	Main Processor	Industrial embedded micro controller	
	OS	Embedded LINUX	
Video Parameters	Video Encode Standard	H.264	
	Encode Resolution	1080P(1~15fps) /720P/960H/D1/HD1/2CIF/CIF/QCIF	
	Video Frame Rate	HDCVI:1~25f/s (PAL) ; 1~30f/s (NTSC) CVBS:1~25f/s (PAL) ; 1~30f/s (NTSC)	
	Video Bit Rate	2048Kbps-4096Kbps, For 1080P/720P: default setup is 2Mbps,max supports 4Mbps. For 960H: default setup is 1Mbps,max supports 3Mbps.	
	Bit Stream Type	Video stream/composite stream	
	Dual-Stream	Support	
Audio Parameters	Encode Standard	G.711A/G.711U/PCM	
	Audio Sampling Rate	8KHz,16Bit	
	Audio Bit Rate	64Kbps	
Video Port	Analog Video Input	4-channel,BNC port	8-channel,BNC port
	Network Video Input	Max 2-channel IPC connections (8M)	
	Video Output	1-channel VGA output, 1-channel HDMI output (of the same video source), HDMI/ VGA video output at the same time.	
	Loop Output	N/A	
	Matrix Output	N/A	
Audio Port	Audio Input	1-channel RCA port.	
	Audio Output	1-channel RCA port.	
	Bidirectional Talk Input	Reuse the audio input/output port.	
Record	Record Mode	Schedule record/manual record/MD record/Alarm record	
	Record Playback	Max 4-channel playback	Max 8-channel playback
	Backup Mode	HDD, burner, USB device, network backup	
Alarm	Alarm Input	N/A	
	Alarm Output	N/A	
HDD	HDD Port	1 SATA port,does not support eSATA port	
	One HDD Space	4T	

	Parameters	HCVR5104C-S2	HCVR5108C-S2
Communication Port	Network	1 RJ45 port, 100Mbps Ethernet port	
	Communication	N/A	
	USB	2 USB ports	
Others	Power	DC12V	
	Power Consumption	≤15W (With power adapter, no HDD)	
	Working Temperature	-10°C ~ +55°C	
	Working Humidity	10%~90%	
	Dimensions	SMART 1U case, 270mm (W) x 205mm (D) x 41mm (H)	
	Weight	1.25KG (No HDD)	
	Installation Mode	Desk	

1.3.6 HCVR7104C-S2 Series

	Parameters	HCVR7104C-S2
System	Main Processor	Industrial embedded micro controller
	OS	Embedded LINUX
Video Parameters	Video Encode Standard	H.264
	Encode Resolution	1080P/720P/960H/D1/HD1/2CIF/CIF/QCIF
	Video Frame Rate	HDCVI: 1~25f/s (PAL) ; 1~30f/s (NTSC) CVBS: 1~25f/s (PAL) ; 1~30f/s (NTSC)
	Video Bit Rate	2048Kbps-6144Kbps, For 1080P: default setup is 4Mbps, max supports 6Mbps. For 720P: default setup is 2Mbps, max supports 4Mbps.
	Bit Stream Type	Video stream/composite stream
	Dual-Stream	Support
Audio Parameters	Encode Standard	G.711A/G.711U/PCM
	Audio Sampling Rate	8KHz, 16Bit
	Audio Bit Rate	64Kbps
Video Port	Analog Video Input	4-channel, BNC port
	Network Video Input	Max 2-channel IPC connections (16M)
	Video Output	1-channel VGA output, 1-channel HDMI output (of the same video source),

	Parameters	HCVR7104C-S2
		HDMI/ VGA video output at the same time.
	Loop Output	N/A
	Matrix Output	N/A
Audio Port	Audio Input	1-channel RCA port.
	Audio Output	1-channel RCA port.
	Bidirectional Talk Input	Reuse the audio input/output port.
Record	Record Mode	Schedule record/manual record/MD record/Alarm record
	Record Playback	Max 4-channel playback
	Backup Mode	HDD, burner, USB device, network backup
Alarm	Alarm Input	N/A
	Alarm Output	N/A
HDD	HDD Port	1 SATA port,does not support eSATA port
	One HDD Space	4T
Communication Port	Network	1 RJ45 port, 100Mbps Ethernet port
	Communication	N/A
	USB	2 USB ports
Others	Power	DC12V
	Power Consumption	≤15W (With power adapter, no HDD)
	Working Temperature	-10℃~+55℃
	Working Humidity	10%~90%
	Dimensions	SMART 1U case,270mm (W) x205mm (D) x41mm (H)
	Weight	1.25KG (No HDD)
	Installation Mode	Desk

1.3.7 HCVR2108C-S2 Series

	Parameters	HCVR2108C-S2
System	Main Processor	Industrial embedded micro controller
	OS	Embedded LINUX
Video Parameters	Video Encode Standard	H.264
	Encode Resolution	720P(1~15fps) /960H/D1/HD1/2CIF/CIF/QCIF
	Video Frame Rate	HDCVI:1~12f/s CVBS:1~20f/s (PAL) ; 1~20f/s (NTSC)
	Video Bit Rate	1024Kbps-4096Kbps,

	Parameters	HCVR2108C-S2
		For 720P: default setup is 1Mbps,max supports 4Mbps. For 1080P: default setup is 1Mbps,max supports 2Mbps.
	Bit Stream Type	Video stream/composite stream
	Dual-Stream	Support
Audio Parameters	Encode Standard	G.711A/G.711U/PCM
	Audio Sampling Rate	8KHz,16Bit
	Audio Bit Rate	64Kbps
Video Port	Analog Video Input	8-channel,BNC port
	Video Output	1-channel VGA output, 1-channel HDMI output (of the same video source), HDMI/ VGA video output at the same time.
	Loop Output	N/A
	Matrix Output	N/A
Audio Port	Audio Input	1-channel RCA port.
	Audio Output	1-channel RCA port.
	Bidirectional Talk Input	Reuse the audio input/output port.
Record	Record Mode	Schedule record/manual record/MD record/Alarm record
	Record Playback	Max 8-channel playback
	Backup Mode	HDD, burner, USB device, network backup
Alarm	Alarm Input	N/A
	Alarm Output	N/A
HDD	HDD Port	1 SATA port,does not support eSATA port
	One HDD Space	4T
Communication Port	Network	1 RJ45 port, 100Mbps Ethernet port
	Communication	N/A
	USB	2 USB ports
Others	Power	DC12V
	Power Consumption	≤15W (With power adapter, no HDD)
	Working Temperature	-10℃~+55℃
	Working Humidity	10%~90%
	Dimensions	SMART 1U case,270mm (W) x205mm (D) x41mm (H)
	Weight	1.25KG (No HDD)
	Installation	Desk

	Parameters	HCVR2108C-S2
	Mode	

1.3.8 HCVR410XC-S3 Series

	Parameters	HCVR4104C-S3	HCVR4108C-S3
System	Main Processor	Industrial embedded micro controller	
	OS	Embedded LINUX	
Video Parameters	Video Encode Standard	H.264	
	Encode Resolution	1080N/720P/960H/D1/HD1/2CIF/CIF	1080N@12f/720P(Non realtime)/960H/D1/HD1/2CIF/CIF
	Video Frame Rate	PAL:1~25f/s; NTSC:1~30f/s	
	Video Bit Rate	32Kbps-4096Kbps, For 720P: default setup is 1.5Mbps,max supports 4Mbps. For 1080P: default setup is 1.5Mbps,max supports 4Mbps.	
	Bit Stream Type	Video stream/composite stream	
	Dual-Stream	Support	
Audio Parameters	Encode Standard	G.711A/G.711U/PCM	
	Audio Sampling Rate	8KHz,16Bit	
	Audio Bit Rate	64Kbps	
Video Port	Analog Video Input	4-ch BNC port(HDCVI HD video/general standard definition video self-adaptive)	8-ch BNC port(HDCVI HD video/general standard definition video self-adaptive)
	Network Video Input	<ul style="list-style-type: none"> ● Max add 1 IP channel connection ● Analog/digital channel switch. Max 5 IP channel connections ● Connection bandwidth:4Mbps-20Mbps 	<ul style="list-style-type: none"> ● Max add 2 IP channel connections ● Analog/digital channel switch. Max 10 IP channel connections ● Connection bandwidth:8Mbps-56Mbps
	Video Output	1-channel VGA output, 1-channel HDMI output (of the same video source), HDMI/ VGA video output at the same time.	
	Loop Output	N/A	
	Matrix Output	N/A	
Audio Port	Audio Input	1-channel RCA port.	
	Coaxial Audio Input	4-ch	8-ch

	Parameters	HCVR4104C-S3	HCVR4108C-S3
	Audio Output	1-channel RCA port.	
	Bidirectional Talk Input	Reuse the audio input/output port of the 1 st channel.	
Record	Record Mode	Schedule record/manual record/MD record/Alarm record	
	Playback Mode	Instant playback, normal playback, event playback, mark playback, smart playback	
	Backup Mode	HDD, burner, USB device, network backup	
Alarm	Alarm Input	N/A	
	Alarm Output	N/A	
HDD	HDD Port	1 SATA port, does not support eSATA port	
	One HDD Space	6T	
Communication Port	Network	1 RJ45 port, 100Mbps Ethernet port	
	Communication	RS485 port	
	USB	2 USB2.0 ports(at the rear panel)	
Others	Power	DC12V	
	Power Consumption (No HDD)	≤7W	≤8W
	Working Temperature	-10°C ~ +55°C	
	Working Humidity	10%~90%	
	Dimensions	SMART 1U case, 270mm (W) x205mm (D) x41mm (H)	
	Weight (No HDD)	≤0.5KG	≤0.55KG
	Installation Mode	Desk	

1.3.9 HCVR510XC-S3 Series

	Parameters	HCVR5104C-S3	HCVR5108C-S3
System	Main Processor	Industrial embedded micro controller	
	OS	Embedded LINUX	
Video Parameters	Video Encode Standard	H.264	
	Encode Resolution	1080P@15f/1080N/720P/960H/D1/HD1/2CIF/CIF/	
	Video Frame Rate	PAL:1~25f/s; NTSC:1~30f/s	
	Video Bit Rate	32Kbps-6144Kbps, For 720P: default setup is 2Mbps,max supports 4Mbps. For 1080P: default setup is 2Mbps,max supports 6Mbps.	

	Parameters	HCVR5104C-S3	HCVR5108C-S3
	Bit Stream Type	Video stream/composite stream	
	Dual-Stream	Support	
Audio Parameters	Encode Standard	G.711A/G.711U/PCM	
	Audio Sampling Rate	8KHz,16Bit	
	Audio Bit Rate	64Kbps	
Video Port	Analog Video Input	4-ch BNC port(HDCVI HD video/general standard definition video self-adaptive)	8-ch BNC port(HDCVI HD video/general standard definition video self-adaptive)
	Network Video Input	<ul style="list-style-type: none"> ● Max add 1 IP channel connection ● Analog/digital channel switch. Max 5 IP channel connections ● Connection bandwidth:8Mbps-24Mbps 	<ul style="list-style-type: none"> ● Max add 2 IP channel connections ● Analog/digital channel switch. Max 10 IP channel connections ● Connection bandwidth:16Mbps-48Mbps
	Video Output	1-channel VGA output, 1-channel HDMI output (of the same video source), HDMI/ VGA video output at the same time.	
	Loop Output	N/A	
	Matrix Output	N/A	
Audio Port	Audio Input	1-channel RCA port.	
	Coaxial Audio Input	4-ch	8-ch
	Audio Output	1-channel RCA port.	
	Bidirectional Talk Input	Reuse the audio input/output port of the 1st channel.	
Record	Record Mode	Schedule record/manual record/MD record/Alarm record	
	Playback Mode	Instant playback, normal playback, event playback, mark playback, smart playback	
	Backup Mode	HDD, burner, USB device, network backup	
Alarm	Alarm Input	N/A	
	Alarm Output	N/A	
HDD	HDD Port	1 SATA port,does not support eSATA port	
	One HDD Space	6T	
Communication Port	Network	1 RJ45 port, 100Mbps Ethernet port	
	Communication	RS485 port	
	USB	2 USB2.0 ports(at the rear panel)	
Others	Power	DC12V	

	Parameters	HCVR5104C-S3	HCVR5108C-S3
	Power Consumption (No HDD)	≤7W	≤8W
	Working Temperature	-10℃~+55℃	
	Working Humidity	10%~90%	
	Dimensions	SMART 1U case, 270mm (W) x205mm (D) x41mm (H)	
	Weight (No HDD)	≤0.5KG	≤0.55KG
	Installation Mode	Desk	

1.3.10 HCVR7104C-S3 Series

	Parameters	HCVR7104C-S3
System	Main Processor	Industrial embedded micro controller
	OS	Embedded LINUX
Video Parameters	Video Encode Standard	H.264
	Encode Resolution	1080P/720P/960H/D1/HD1/2CIF/CIF
	Video Frame Rate	PAL:1~25f/s; NTSC:1~30f/s
	Video Bit Rate	32Kbps-6144Kbps, For 720P: default setup is 2Mbps,max supports 4Mbps. For 1080P: default setup is 4Mbps,max supports 6Mbps.
	Bit Stream Type	Video stream/composite stream
	Dual-Stream	Support
Audio Parameters	Encode Standard	G.711A/G.711U/PCM
	Audio Sampling Rate	8KHz,16Bit
	Audio Bit Rate	64Kbps
Video Port	Analog Video Input	4-ch BNC port(HDCVI HD video/general standard definition video self-adaptive)
	Network Video Input	<ul style="list-style-type: none"> ● Max add 2 IP channel connections. ● Analog/digital channel switch. Max 6 IP channel connections. ● Connection bandwidth:8Mbps-24Mbps
	Video Output	1-channel VGA output, 1-channel HDMI output (of the same video source), HDMI/ VGA video output at the same time.
	Loop Output	N/A

	Parameters	HCVR7104C-S3
	Matrix Output	N/A
Audio Port	Audio Input	1-channel RCA port.
	Coaxial Audio Input	4-ch
	Audio Output	1-channel RCA port.
	Bidirectional Talk Input	Reuse the audio input/output port of the 1st channel.
Record	Record Mode	Schedule record/manual record/MD record/Alarm record
	Playback Mode	Instant playback, normal playback, event playback, mark playback, smart playback
	Backup Mode	HDD, burner, USB device, network backup
Alarm	Alarm Input	N/A
	Alarm Output	N/A
HDD	HDD Port	1 SATA port, does not support eSATA port
	One HDD Space	6T
Communication Port	Network	1 RJ45 port, 100Mbps Ethernet port
	Communication	RS485 port
	USB	2 USB2.0 ports(at the rear panel)
Others	Power	DC12V
	Power Consumption (No HDD)	≤8W
	Working Temperature	-10℃~+55℃
	Working Humidity	10%~90%
	Dimensions	SMART 1U case, 270mm (W) x205mm (D) x41mm (H)
	Weight (No HDD)	≤0.5KG
	Installation Mode	Desk

1.3.11 HCVR51XXH Series

	Parameter	HCVR5104H	HCVR5108H
System	Main Processor	High-performance industrial embedded micro controller	
	OS	Embedded LINUX	
	System Resources	Multiplex operations: Multiple-channel record, multiple-channel playback and network operation simultaneously	
	Interface	User-friendly graphical user interface	

	Input Devices	USB mouse	
	Input Method	Arabic number, English character, donation and extension Chinese (optional)	
	Shortcut Function	Copy/paste operation, USB mouse right-key shortcut menu, double click USB mouse to switch screen.	
Compression Standard	Video Compression	H.264	
	Audio Compression	G711A, G711U, PCM	
Video monitor	Video Input	4-CH composite video input: (NTSC/PAL) BNC (1.0V _{P-P} , 75Ω)	8-CH composite video input: (NTSC/PAL) BNC (1.0V _{P-P} , 75Ω)
	Video Output	1-ch VGA output. 1-ch HDMI output. Support VGA/HDMI video output at the same time.	
	Video Standard	Support PAL/NTSC.	
	Record Speed	Real-time Mode: PAL 1f/s to 25f/s per channel and NTSC 1f/s to 30f/s per channel	
	Video Partition	1/4 windows(Optional)	1/4/8/9 windows
	Monitor Touring	Support monitor tour functions such as motion detection, and schedule auto control.	
	Resolution (PAL/NTSC)	PAL/NTSC Real-time monitor: 720P 1280*720	
		Playback: All-ch: 720P 1280*720, 960H 960 x576/960x480, D1 704x576/704x480, HD1 352x576/352x480, 2CIF 704x288/704x240, CIF 352x288/ 352x240 , QCIF 176x144/176x120	
		Support dual streams: extra stream resolution CIF 352x288/ 352x240, QCIF 176x144/176x120.	
	Image Quality	6-level image quality (Adjustable)	
	Privacy mask	Support one privacy mask of user-defined size in full screen. Support max 4 zones.	
	Image Information	Channel information, time information and privacy mask zone.	
TV Adjust	Adjust TV output zone suitable to anamorphic video.		

	Channel Lock	Cover secret channel with black screen though system is encoding normally. Screen-lock function to prevent unauthorized user seeing secret video.
	Channel Information	Channel name, recording status, screen lock status, video loss status and motion detection status are shown on the bottom left of display screen.
	Color Configuration	Hue, brightness, contrast, saturation and gain setup for each channel.
Audio	Audio Input	1-ch 200-2000mv 10KΩ(RCA)
	Audio Output	1-ch audio output 200-3000mv 5KΩ(RCA)
	Bidirectional Audio	Reuse the audio input/output channel.
Hard disk	Hard Disk	1 built-in SATA port. Support 1 HDD.
	One HDD Space	4T
	Hard Disk Occupation	Audio:PCM 28.8MByte/h Video:56-900MByte/h
Record and playback	Recording Mode	Manual recording, motion detection recording, schedule recording and alarm recording Priority: Manual recording> alarm recording>motion detection recording>schedule recording.
	Storage Mode	Support channel record quota setup
	Recording Length	1 to 120 minutes single record duration (Default setup is 60 minutes)
	Playback Repeat Way	When hard disk is full, system can overwrite previous video file.
	Record Search	Various search engines such as time, type and channel.
	Playback Mode	Various fast play, slow play speeds, manual frame by frame playback and reverse play mode.
	Various File Switch Ways	Can switch to previous or next file or any file in current play list. Can switch to file on other channel of the same time. (If there is a file) Support file continuous play, when a file is end system auto plays the next file in the current channel
	Playback Way	Support mark playback
	Multi-channel Playback	There is 1/4-channel playback mode.
	Window Zoom	Switch between self-adaptive screen/full screen when playback

	Partial Enlargement	When in one-window full-screen playback mode, you can select any zone to activate partial enlargement function.
Backup function	Backup Mode	HDD backup
		Support peripheral USB backup device. (Flash disk, portable disk and etc.)
		Support network download and save
Network Function	Network control	View monitor channel remotely.
		DVR configuration through client-end and web browser
		Upgrade via client or browser to realize remote maintenance.
		View alarm information such as motion detection and video loss via client.
		Support network PTZ lens control
		File download backup and playback
		Multiple devices share information via corresponding software such as professional surveillance software (PSS)
		Duplex transparent COM
		Network alarm input and output
		Zero-channel encoding.
		Bidirectional audio.
Motion Detection and Alarm	Motion Detection	Zone setup: support 396((PAL 22×18, NTSC 22×15)) detection zones. Various sensitivity levels. Alarm can activate record or external alarm or screen message prompt.
	Video Loss	Alarm can activate screen message prompt.
	External Alarm	N/A
	Manual Alarm Control	N/A
	Alarm Input	N/A
	Alarm Output	N/A
	Alarm Relay	N/A
Interface	USB Interface	2 USB 2.0 ports.
	Network connection	1 RJ45 10M/100M self-adaptable Ethernet port
	RS485	PTZ control port Support various PTZ control protocols.
	RS232	N/A
System Information	Hard Disk Information	Display HDD current status

	Data Stream Statistics	Data stream statistics for each channel (in wave mode)
	Log statistics	Backup to 1024 log files. Support various search engines such as time and type.
	Version	Display version information: channel amount, system version and release date.
	On-line user	Display current on-line user
User Management	User Management	Multi-lever user management; various management modes Integrated management for local user, serial port user and network user. Configurable user power.
		Support user /group and its corresponding rights modification. No limit to the user or group amount.
	Password Authentication	Password modification Administrator can modify other user's password.
		Account lock strategy Five times login failure in thirty minutes may result in account lock.
Upgrade		Web browser, client-end and update tool.
Login, Logout and Shutdown		Password login protection to guarantee safety
		User-friendly interface when login. Provide the following options: Logout /shutdown/ restart.
		Right authentication when shut down to make sure only those proper people can turn off DVR
General Parameter	Power	DC 12V
	Power Consumption	≤15W (With adapter, exclude HDD)
	Working Temperature	-10℃~+55℃
	Working Humidity	10%—90%
	Air Pressure	86kpa—106kpa
	Dimension	325(W) x245 (D) x45mm(H)
	Weight	1.25KG(Exclude HDD)
	Installation Mode	Desktop installation

1.3.12 HCVR51XXH-V2 Series

	Parameters	HCVR5104H-V2	HCVR5108H-V2	HCVR5116H-V2
System	Main Processor	Industrial embedded micro controller		
	OS	Embedded LINUX		

	Parameters	HCVR5104H-V2	HCVR5108H-V2	HCVR5116H-V2
Video Parameters	Video Encode Standard	H.264		
	Encode Resolution	720P/D1/HD1/2CIF/CIF/QCIF		
	Video Frame Rate	PAL:1~25f/s; NTSC:1~30f/s		
	Video Bit Rate	1536Kbps-4096Kbps, For 720P: default setup is 2Mbps,max supports 4Mbps		
	Bit Stream Type	Video stream/composite stream		
	Dual-Stream	Support		
Audio Parameters	Encode Standard	G.711A/G.711U/PCM		
	Audio Sampling Rate	8KHz,16Bit		
	Audio Bit Rate	64Kbps		
Video Port	Analog Video Input	4-channel,BNC port	8-channel,BNC port	16-channel,BNC port
	Network Video Input	N/A		
	Video Output	1-channel VGA output, 1-channel HDMI output (of the same video source), HDMI/ VGA video output at the same time.		
	Loop Output	N/A		
	Matrix Output	N/A		
Audio Port	Audio Input	1-channel RCA		
	Audio Output	1-channel RCA		
	Bidirectional Talk Input	Support (reuse the audio port)		
Record	Record Mode	Schedule record/manual record/MD record/Alarm record		
	Record Playback	Max 4-channel playback	Max 8-channel playback	Max 16-channel playback
	Backup Mode	HDD, burner, USB device, network backup		
Alarm	Alarm Input	N/A		
	Alarm Output	N/A		
HDD	HDD Port	1 SATA port,does not support eSATA port		
	One HDD Space	4T		
Communication Port	Network	1 RJ45 port, 100Mbps Ethernet port		
	Communication	RS485 port		
	USB	2 USB ports		
Others	Power	DC12V		
	Power	≤30W (With power adapter, no HDD)		

	Parameters	HCVR5104H-V2	HCVR5108H-V2	HCVR5116H-V2
	Consumption			
	Working Temperature	-10℃~+55℃		
	Working Humidity	10%~90%		
	Dimensions	Mini 1U case,325mm (W) x245mm (D) x45mm (H)		
	Weight	1.25KG (No HDD)		
	Installation Mode	Desk		

1.3.13 HCVR51XXHC Series

	Parameter	HCVR5104HC	HCVR5108HC
System	Main Processor	High-performance industrial embedded micro controller	
	OS	Embedded LINUX	
	System Resources	Multiplex operations: Multiple-channel record, multiple-channel playback and network operation simultaneously	
	Interface	User-friendly graphical user interface	
	Input Devices	USB mouse	
	Input Method	Arabic number, English character, donation and extension Chinese (optional)	
	Shortcut Function	Copy/paste operation, USB mouse right-key shortcut menu, double click USB mouse to switch screen.	
Compression Standard	Video Compression	H.264	
	Audio Compression	N/A	
Video monitor	Video Input	4-CH composite video input: (NTSC/PAL) BNC (1.0V _{P-P} , 75Ω)	8-CH composite video input: (NTSC/PAL) BNC (1.0V _{P-P} , 75Ω)
	Video Output	1-ch VGA output. 1-ch HDMI output. Support VGA/HDMI video output at the same time.	
	Video Standard	Support PAL/NTSC.	
	Record Speed	Real-time Mode: PAL 1f/s to 25f/s per channel and NTSC 1f/s to 30f/s per channel	
	Video Partition	1/4 windows(Optional)	1/4/8/9 windows

	Monitor Touring	Support monitor tour functions such as motion detection, and schedule auto control.
	Resolution (PAL/NTSC)	PAL/NTSC Real-time monitor: 720P 1280*720
		Playback: All-ch: 720P 1280*720, 960H 960 x576/960x480, D1 704x576/704x480, HD1 352x576/352x480, 2CIF 704x288/704x240, CIF 352x288/ 352x240 , QCIF 176x144/176x120
		Support dual streams: extra stream resolution CIF 352x288/ 352x240, QCIF 176x144/176x120.
	Image Quality	6-level image quality (Adjustable)
	Privacy mask	Support one privacy mask of user-defined size in full screen. Support max 4 zones.
	Image Information	Channel information, time information and privacy mask zone.
	TV Adjust	Adjust TV output zone suitable to anamorphic video.
	Channel Lock	Cover secret channel with black screen though system is encoding normally. Screen-lock function to prevent unauthorized user seeing secret video.
	Channel Information	Channel name, recording status, screen lock status, video loss status and motion detection status are shown on the bottom left of display screen.
	Color Configuration	Hue, brightness, contrast, saturation and gain setup for each channel.
Audio	Audio Input	N/A
	Audio Output	N/A
	Bidirectional Audio	N/A
Hard disk	Hard Disk	1 built-in SATA port. Support 1 HDD.
	One HDD Space	4T
	Hard Disk Occupation	Audio:PCM 28.8MByte/h Video:56-900MByte/h
Record and	Recording Mode	Manual recording, motion detection recording, schedule recording and alarm recording Priority: Manual recording> alarm recording>motion detection recording>schedule recording.

playback	Storage Mode	Support channel record quota setup
	Recording Length	1 to 120 minutes single record duration (Default setup is 60 minutes)
	Playback Repeat Way	When hard disk is full, system can overwrite previous video file.
	Record Search	Various search engines such as time, type and channel.
	Playback Mode	Various fast play, slow play speeds, manual frame by frame playback and reverse play mode.
	Various File Switch Ways	Can switch to previous or next file or any file in current play list. Can switch to file on other channel of the same time. (If there is a file) Support file continuous play, when a file is end system auto plays the next file in the current channel
	Playback Way	Support mark playback
	Multi-channel Playback	There is 1/4-channel playback mode.
	Window Zoom	Switch between self-adaptive screen/full screen when playback
	Partial Enlargement	When in one-window full-screen playback mode, you can select any zone to activate partial enlargement function.
Backup function	Backup Mode	HDD backup
		Support peripheral USB backup device. (Flash disk, portable disk and etc.)
		Support network download and save
Network Function	Network control	View monitor channel remotely.
		DVR configuration through client-end and web browser
		Upgrade via client or browser to realize remote maintenance.
		View alarm information such as motion detection and video loss via client.
		Support network PTZ lens control
		File download backup and playback
		Multiple devices share information via corresponding software such as professional surveillance software (PSS)
		Duplex transparent COM
		Network alarm input and output
		Zero-channel encoding.
		Bidirectional audio.
Motion Detection and Alarm	Motion Detection	Zone setup: support 396((PAL 22×18, NTSC 22×15)) detection zones. Various sensitivity levels. Alarm can activate record or external alarm or screen message prompt.
	Video Loss	Alarm can activate screen message prompt.

	External Alarm	N/A
	Manual Alarm Control	N/A
	Alarm Input	N/A
	Alarm Output	N/A
	Alarm Relay	N/A
Interface	USB Interface	2 USB 2.0 port.
	Network connection	1 RJ45 10M/100M self-adaptable Ethernet port
	RS485	N/A
	RS232	N/A
System Information	Hard Disk Information	Display HDD current status
	Data Stream Statistics	Data stream statistics for each channel (in wave mode)
	Log statistics	Backup to 1024 log files. Support various search engines such as time and type.
	Version	Display version information: channel amount, system version and release date.
	On-line user	Display current on-line user
User Management	User Management	Multi-lever user management; various management modes Integrated management for local user, serial port user and network user. Configurable user power.
		Support user /group and its corresponding rights modification. No limit to the user or group amount.
	Password Authentication	Password modification Administrator can modify other user's password.
		Account lock strategy Five times login failure in thirty minutes may result in account lock.
Upgrade		Web browser, client-end and update tool.
Login, Logout and Shutdown		Password login protection to guarantee safety
		User-friendly interface when login. Provide the following options: Logout /shutdown/ restart.
		Right authentication when shut down to make sure only those proper people can turn off DVR
	Power	DC 12V

General Parameter	Power Consumption	≤15W (With adapter, exclude HDD)
	Working Temperature	-10℃~+55℃
	Working Humidity	10%—90%
	Air Pressure	86kpa—106kpa
	Dimension	325(W) x245 (D) x45mm(H)
	Weight	1.25KG(Exclude HDD)
	Installation Mode	Desktop installation

1.3.14 HCVR51XXHC-V2 Series

	Parameters	HCVR5104HC-V2	HCVR5108HC-V2	HCVR5116HC-V2
System	Main Processor	Industrial embedded micro controller		
	OS	Embedded LINUX		
Video Parameters	Video Encode Standard	H.264		
	Encode Resolution	720P/D1/HD1/2CIF/CIF/QCIF		
	Video Frame Rate	PAL:1~25f/s; NTSC:1~30f/s		
	Video Bit Rate	1536Kbps-4096Kbps, For 720P: default setup is 2Mbps,max supports 4Mbps		
	Bit Stream Type	Video stream/composite stream		
	Dual-Stream	Support		
Audio Parameters	Encode Standard	G.711A/G.711U/PCM		
	Audio Sampling Rate	8KHz,16Bit		
	Audio Bit Rate	64Kbps		
Video Port	Analog Video Input	4-channel,BNC port	8-channel,BNC port	16-channel,BNC port
	Network Video Input	N/A		
	Video Output	1-channel VGA output, 1-channel HDMI output (of the same video source), HDMI/ VGA video output at the same time.		
	Loop Output	N/A		
	Matrix Output	N/A		
Audio Port	Audio Input	N/A		
	Audio Output	N/A		

	Parameters	HCVR5104HC-V2	HCVR5108HC-V2	HCVR5116HC-V2
	Bidirectional Talk Input	N/A		
Record	Record Mode	Schedule record/manual record/MD record/Alarm record		
	Record Playback	Max 4-channel playback	Max 8-channel playback	Max 16-channel playback
	Backup Mode	HDD, burner, USB device, network backup		
Alarm	Alarm Input	N/A		
	Alarm Output	N/A		
HDD	HDD Port	1 SATA port, does not support eSATA port		
	One HDD Space	4T		
Communication Port	Network	1 RJ45 port, 100Mbps Ethernet port		
	Communication	RS485 port		
	USB	2 USB ports		
Others	Power	DC12V		
	Power Consumption	≤30W (With power adapter, no HDD)		
	Working Temperature	-10°C ~ +55°C		
	Working Humidity	10%~90%		
	Dimensions	Mini 1U case, 325mm (W) × 245mm (D) × 45mm (H)		
	Weight	1.25KG (No HDD)		
	Installation Mode	Desk		

1.3.15 HCVR51XXHE Series

	Parameter	HCVR5104HE	HCVR5108HE
System	Main Processor	High-performance industrial embedded micro controller	
	OS	Embedded LINUX	
	System Resources	Multiplex operations: Multiple-channel record, multiple-channel playback and network operation simultaneously	
	Interface	User-friendly graphical user interface	
	Input Devices	USB mouse	
	Input Method	Arabic number, English character, donation and extension Chinese (optional)	
	Shortcut Function	Copy/paste operation, USB mouse right-key shortcut menu, double click USB mouse to switch screen.	

Compression Standard	Video Compression	H.264	
	Audio Compression	G711A, G711U, PCM	
Video monitor	Video Input	4-CH composite video input: (NTSC/PAL) BNC (1.0V _{P-P} , 75Ω)	8-CH composite video input: (NTSC/PAL) BNC (1.0V _{P-P} , 75Ω)
	Video Output	1-ch VGA output. 1-ch HDMI output. Support VGA/HDMI video output at the same time.	
	Video Standard	Support PAL/NTSC.	
	Record Speed	Real-time Mode: PAL 1f/s to 25f/s per channel and NTSC 1f/s to 30f/s per channel	
	Video Partition	1/4 windows(Optional)	1/4/8/9 windows
	Monitor Touring	Support monitor tour functions such as motion detection, and schedule auto control.	
	Resolution (PAL/NTSC)	PAL/NTSC Real-time monitor: 720P 1280*720	
		Playback: All-ch: 720P 1280*720, 960H 960 x576/960x480, D1 704x576/704x480, HD1 352x576/352x480, 2CIF 704x288/704x240, CIF 352x288/ 352x240 , QCIF 176x144/176x120	
		Support dual streams: extra stream resolution CIF 352x288/ 352x240, QCIF 176x144/176x120.	
	Image Quality	6-level image quality (Adjustable)	
	Privacy mask	Support one privacy mask of user-defined size in full screen. Support max 4 zones.	
	Image Information	Channel information, time information and privacy mask zone.	
	TV Adjust	Adjust TV output zone suitable to anamorphic video.	
Channel Lock	Cover secret channel with black screen though system is encoding normally. Screen-lock function to prevent unauthorized user seeing secret video.		
Channel Information	Channel name, recording status, screen lock status, video loss status and motion detection status are shown on the bottom left of display screen.		

	Color Configuration	Hue, brightness, contrast, saturation and gain setup for each channel.
Audio	Audio Input	1-ch 200-2000mv 10KΩ(RCA)
	Audio Output	1-ch audio output 200-3000mv 5KΩ(RCA)
	Bidirectional Audio	Reuse the audio input/output channel.
Hard disk	Hard Disk	1 built-in SATA port. Support 1 HDD.
	One HDD Space	4T
	Hard Disk Occupation	Audio:PCM 28.8MByte/h Video:56-900MByte/h
Record and playback	Recording Mode	Manual recording, motion detection recording, schedule recording and alarm recording Priority: Manual recording> alarm recording>motion detection recording>schedule recording.
	Storage Mode	Support channel record quota setup
	Recording Length	1 to 120 minutes single record duration (Default setup is 60 minutes)
	Playback Repeat Way	When hard disk is full, system can overwrite previous video file.
	Record Search	Various search engines such as time, type and channel.
	Playback Mode	Various fast play, slow play speeds, manual frame by frame playback and reverse play mode.
	Various File Switch Ways	Can switch to previous or next file or any file in current play list. Can switch to file on other channel of the same time. (If there is a file) Support file continuous play, when a file is end system auto plays the next file in the current channel
	Playback Way	Support mark playback
	Multi-channel Playback	There is 1/4-channel playback mode.
	Window Zoom	Switch between self-adaptive screen/full screen when playback
	Partial Enlargement	When in one-window full-screen playback mode, you can select any zone to activate partial enlargement function.

Backup function	Backup Mode	HDD backup	
		Support peripheral USB backup device. (Flash disk, portable disk and etc.)	
		Support network download and save	
Network Function	Network control	View monitor channel remotely.	
		DVR configuration through client-end and web browser	
		Upgrade via client or browser to realize remote maintenance.	
		View alarm information such as motion detection and video loss via client.	
		Support network PTZ lens control	
		File download backup and playback	
		Multiple devices share information via corresponding software such as professional surveillance software (PSS)	
		Duplex transparent COM	
		Network alarm input and output	
Motion Detection and Alarm	Motion Detection	Zone setup: support 396((PAL 22×18, NTSC 22×15)) detection zones.	
		Various sensitivity levels.	
		Alarm can activate record or external alarm or screen message prompt.	
	Video Loss	Alarm can activate screen message prompt.	
		Support record activation function or activate external alarm or screen message in specified period.	
	External Alarm	Enable or disable alarm input channel	
		Support analog alarm signal to specific alarm output channel.	
Manual Alarm Control	4-ch alarm input (NO/NC)		8-ch alarm input (NO/NC)
	Alarm Output		3-channel relay output.
Alarm Relay	30V DC 2A,125VAC 1A (activation alarm)		
Interface	USB Interface	2 USB 2.0 ports.	
	Network connection	One RJ45 10M/100M self-adaptable Ethernet port	
	RS485	PTZ control port Support various PTZ control protocols.	
	RS232	N/A	
System Information	Hard Disk Information	Display HDD current status	
	Data Stream Statistics	Data stream statistics for each channel (in wave mode)	
	Log statistics	Backup to 1024 log files. Support various search engines such as time and type.	

	Version	Display version information: channel amount, system version and release date.
	On-line user	Display current on-line user
User Management	User Management	Multi-lever user management; various management modes Integrated management for local user, serial port user and network user. Configurable user power.
		Support user /group and its corresponding rights modification. No limit to the user or group amount.
	Password Authentication	Password modification Administrator can modify other user's password.
		Account lock strategy Five times login failure in thirty minutes may result in account lock.
Upgrade		Web browser, client-end and update tool.
Login, Logout and Shutdown		Password login protection to guarantee safety
		User-friendly interface when login. Provide the following options: Logout /shutdown/ restart.
		Right authentication when shut down to make sure only those proper people can turn off DVR
General Parameter	Power	DC 12V
	Power Consumption	≤15W (With adapter, exclude HDD)
	Working Temperature	-10℃~+55℃
	Working Humidity	10%—90%
	Air Pressure	86kpa—106kpa
	Dimension	325(W) x245 (D) x45mm(H)
	Weight	1.25KG(Exclude HDD)
	Installation Mode	Desktop installation

1.3.16 HCVR51HE-V2 Series

	Parameters	HCVR5104HE-V2	HCVR5108HE-V2	HCVR5116HE-V2
System	Main Processor	Industrial embedded micro controller		
	OS	Embedded LINUX		
Video Parameters	Video Encode Standard	H.264		
	Encode Resolution	720P/D1/HD1/2CIF/CIF/QCIF		
	Video Frame	PAL:1~25f/s; NTSC:1~30f/s		

	Parameters	HCVR5104HE-V2	HCVR5108HE-V2	HCVR5116HE-V2
	Rate			
	Video Bit Rate	1536Kbps-4096Kbps, For 720P: default setup is 2Mbps,max supports 4Mbps		
	Bit Stream Type	Video stream/composite stream		
	Dual-Stream	Support		
Audio Parameters	Encode Standard	G.711A/G.711U/PCM		
	Audio Sampling Rate	8KHz,16Bit		
	Audio Bit Rate	64Kbps		
Video Port	Analog Video Input	4-channel,BNC port	8-channel,BNC port	16-channel,BNC port
	Network Video Input	N/A		
	Video Output	1-channel VGA output, 1-channel HDMI output (of the same video source), HDMI/ VGA video output at the same time.		
	Loop Output	N/A		
	Matrix Output	N/A		
Audio Port	Audio Input	4-channel RCA		
	Audio Output	1-channel RCA		
	Bidirectional Talk Input	Support (reuse the audio port)		
Record	Record Mode	Schedule record/manual record/MD record/Alarm record		
	Record Playback	Max 4-channel playback	Max 8-channel playback	Max 16-channel playback
	Backup Mode	HDD, burner, USB device, network backup		
Alarm	Alarm Input	4-channel alarm input	8-channel alarm input	16-channel alarm input
	Alarm Output	3-channel alarm output		
HDD	HDD Port	1 SATA port,does not support eSATA port		
	One HDD Space	4T		
Communication Port	Network	1 RJ45 port, 100Mbps Ethernet port		
	Communication	RS485 port		
	USB	2 USB ports		
Others	Power	DC12V		
	Power Consumption	≤30W (With power adapter, no HDD)		
	Working Temperature	-10℃~+55℃		
	Working	10%~90%		

	Parameters	HCVR5104HE-V2	HCVR5108HE-V2	HCVR5116HE-V2
	Humidity			
	Dimensions	Mini 1U case,325mm (W) x245mm (D) x45mm (H)		
	Weight	1.25KG (No HDD)		
	Installation Mode	Desk		

1.3.17 HCVR71XXH-V2 Series

	Parameters	HCVR7104H-V2	HCVR7108H-V2
System	Main Processor	Industrial embedded micro controller	
	OS	Embedded LINUX	
Video Parameters	Video Encode Standard	H.264	
	Encode Resolution	1080P /720P/D1/HD1/2CIF/CIF/QCIF	
	Video Frame Rate	PAL:1~25f/s; NTSC:1~30f/s	
	Video Bit Rate	2048Kbps-6144Kbps, For 1080P: default setup is 4Mbps,max supports 6Mbps	
	Bit Stream Type	Video stream/composite stream	
	Dual-Stream	Support	
Audio Parameters	Encode Standard	G.711A/G.711U/PCM	
	Audio Sampling Rate	8KHz,16Bit	
	Audio Bit Rate	64Kbps	
Video Port	Analog Video Input	4-channel,BNC port	8-channel,BNC port
	Network Video Input	N/A	
	Video Output	1-channel VGA output, 1-channel HDMI output (of the same video source), HDMI/ VGA video output at the same time.	
	Loop Output	N/A	
	Matrix Output	N/A	
Audio Port	Audio Input	1-channel RCA	
	Audio Output	1-channel RCA	
	Bidirectional Talk Input	Support (reuse the audio port)	
Record	Record Mode	Schedule record/manual record/MD record/Alarm record	
	Record Playback	Max 4-channel playback	Max 8-channel playback

	Parameters	HCVR7104H-V2	HCVR7108H-V2
	Backup Mode	HDD, burner, USB device, network backup	
Alarm	Alarm Input	N/A	
	Alarm Output	N/A	
HDD	HDD Port	1 SATA port, does not support eSATA port	
	One HDD Space	4T	
Communication Port	Network	1 RJ45 port, 100Mbps Ethernet port	
	Communication	N/A	
	USB	2 USB ports	
Others	Power	DC12V	
	Power Consumption	≤30W (With power adapter, no HDD)	
	Working Temperature	-10°C ~ +55°C	
	Working Humidity	10%~90%	
	Dimensions	Mini 1U case, 325mm (W) x 245mm (D) x 45mm (H)	
	Weight	1.25KG (No HDD)	
	Installation Mode	Desk	

1.3.18 HCVR71XXHC-V2 Series

	Parameters	HCVR7104HC-V2	HCVR7108HC-V2
System	Main Processor	Industrial embedded micro controller	
	OS	Embedded LINUX	
Video Parameters	Video Encode Standard	H.264	
	Encode Resolution	1080P/720P/D1/HD1/2CIF/CIF/QCIF	
	Video Frame Rate	PAL:1~25f/s; NTSC:1~30f/s	
	Video Bit Rate	2048Kbps-6144Kbps, For 1080P: default setup is 4Mbps, max supports 6Mbps	
	Bit Stream Type	Video stream/composite stream	
	Dual-Stream	Support	
Audio Parameters	Encode Standard	G.711A/G.711U/PCM	
	Audio Sampling Rate	8KHz, 16Bit	
	Audio Bit Rate	64Kbps	
Video Port	Analog Video Input	4-channel, BNC port	8-channel, BNC port

	Parameters	HCVR7104HC-V2	HCVR7108HC-V2
	Network Video Input	N/A	
	Video Output	1-channel VGA output, 1-channel HDMI output (of the same video source), HDMI/ VGA video output at the same time.	
	Loop Output	N/A	
	Matrix Output	N/A	
Audio Port	Audio Input	N/A	
	Audio Output	N/A	
	Bidirectional Talk Input	N/A	
Record	Record Mode	Schedule record/manual record/MD record/Alarm record	
	Record Playback	Max 4-channel playback	Max 8-channel playback
	Backup Mode	HDD, burner, USB device, network backup	
Alarm	Alarm Input	N/A	
	Alarm Output	N/A	
HDD	HDD Port	1 SATA port, does not support eSATA port	
	One HDD Space	4T	
Communication Port	Network	1 RJ45 port, 100Mbps Ethernet port	
	Communication	RS485 port	
	USB	2 USB ports	
Others	Power	DC12V	
	Power Consumption	≤30W (With power adapter, no HDD)	
	Working Temperature	-10°C ~ +55°C	
	Working Humidity	10%~90%	
	Dimensions	Mini 1U case, 325mm (W) × 245mm (D) × 45mm (H)	
	Weight	1.25KG (No HDD)	
	Installation Mode	Desk	

1.3.19 HCVR71XHE-V2 Series

	Parameters	HCVR7104HE-V2	HCVR7108HE-V2
System	Main Processor	Industrial embedded micro controller	
	OS	Embedded LINUX	
Video Parameters	Video Encode Standard	H.264	
	Encode	1080P/720P/D1/HD1/2CIF/CIF/QCIF	

	Parameters	HCVR7104HE-V2	HCVR7108HE-V2
	Resolution		
	Video Frame Rate	PAL:1~25f/s; NTSC:1~30f/s	
	Video Bit Rate	2048Kbps-6144Kbps, For 1080P: default setup is 4Mbps,max supports 6Mbps	
	Bit Stream Type	Video stream/composite stream	
	Dual-Stream	Support	
Audio Parameters	Encode Standard	G.711A/G.711U/PCM	
	Audio Sampling Rate	8KHz,16Bit	
	Audio Bit Rate	64Kbps	
Video Port	Analog Video Input	4-channel,BNC port	8-channel,BNC port
	Network Video Input	N/A	
	Video Output	1-channel VGA output, 1-channel HDMI output (of the same video source), HDMI/ VGA video output at the same time.	
	Loop Output	N/A	
	Matrix Output	N/A	
Audio Port	Audio Input	4-channel RCA	
	Audio Output	1-channel RCA	
	Bidirectional Talk Input	Support (reuse the audio port)	
Record	Record Mode	Schedule record/manual record/MD record/Alarm record	
	Record Playback	Max 4-channel playback	Max 8-channel playback
	Backup Mode	HDD, burner, USB device, network backup	
Alarm	Alarm Input	4-channel alarm input	16-channel alarm input
	Alarm Output	3-channel alarm output	
HDD	HDD Port	1 SATA port,does not support eSATA port	
	One HDD Space	4T	
Communication Port	Network	1 RJ45 port, 100Mbps Ethernet port	
	Communication	RS485 port	
	USB	2 USB ports	
Others	Power	DC12V	
	Power Consumption	≤30W (With power adapter, no HDD)	
	Working Temperature	-10℃~+55℃	

	Parameters	HCVR7104HE-V2	HCVR7108HE-V2
	Working Humidity	10%~90%	
	Dimensions	Mini 1U case,325mm (W) x245mm (D) x45mm (H)	
	Weight	1.25KG (No HDD)	
	Installation Mode	Desk	

1.3.20 HCVR41XXHE-S2 Series

	Parameters	HCVR4104HE-S2	HCVR4108HE-S2	HCVR4116HE-S2
System	Main Processor	Industrial embedded micro controller		
	OS	Embedded LINUX		
Video Parameters	Video Encode Standard	H.264		
	Encode Resolution	720P/960H/D1/HD1/2CIF/CIF/QCIF	720P(1~15fps)/960H/D1/HD1/2CIF/CIF/QCIF	
	Video Frame Rate	HDCVI:1~25f/s (PAL); 1~30f/s (NTSC) CVBS:1~25f/s (PAL) ; 1~30f/s (NTSC)	HDCVI:1 ~ 15f/s (The 1 st channel supports 25/30f) CVBS:1~25f/s (PAL) ; 1~30f/s (NTSC)	
	Video Bit Rate	2048Kbps-4096Kbps, For 720P: default setup is 2Mbps,max supports 4Mbps. For 960H: default setup is 1Mbps,max supports 3Mbps.	1024Kbps-4096Kbps, For 720P: default setup is 1Mbps,max supports 4Mbps. For 960H: default setup is 1Mbps,max supports 3Mbps.	
	Bit Stream Type	Video stream/composite stream		
	Dual-Stream	Support		
Audio Parameters	Encode Standard	G.711A/G.711U/PCM		
	Audio Sampling Rate	8KHz,16Bit		
	Audio Bit Rate	64Kbps		
Video Port	Analog Video Input	4-channel,BNC port	8-channel,BNC port	16-channel, BNC port
	Network Video Input	Max 2-channel IPC connections (8M)		
	Video Output	1-channel VGA output, 1-channel HDMI output (of the same video source), HDMI/ VGA video output at the same time.		
	Loop Output	N/A		
	Matrix Output	N/A		

	Parameters	HCVR4104HE-S2	HCVR4108HE-S2	HCVR4116HE-S2
Audio Port	Audio Input	4-channel RCA port.		
	Audio Output	1-channel RCA port.		
	Bidirectional Talk Input	Reuse the audio input/output port.		
Record	Record Mode	Schedule record/manual record/MD record/Alarm record		
	Record Playback	Max 4-channel playback	Max 8-channel playback	Max 16-channel playback
	Backup Mode	HDD, burner, USB device, network backup		
Alarm	Alarm Input	4-channel input	8-channel input	16-channel input
	Alarm Output	3-channel output		
HDD	HDD Port	1 SATA port, does not support eSATA port		
	One HDD Space	4T		
Communication Port	Network	1 RJ45 port, 100Mbps Ethernet port		
	Communication	RS485 port		
	USB	2 USB ports		
Others	Power	DC12V		
	Power Consumption	≤15W (With power adapter, no HDD)		
	Working Temperature	-10°C ~ +55°C		
	Working Humidity	10%~90%		
	Dimensions	Mini 1U case, 325mm (W) x 245mm (D) x 45mm (H)		
	Weight	1.25KG (No HDD)		
	Installation Mode	Desk		

1.3.21 HCVR51XXH-S2 Series

	Parameters	HCVR5104H-S2	HCVR5108H-S2	HCVR5116H-S2
System	Main Processor	Industrial embedded micro controller		
	OS	Embedded LINUX		
Video Parameters	Video Encode Standard	H.264		
	Encode Resolution	1080P(1~15fps)/720P/960H/D1/HD1/2CIF/CIF/QCIF		
	Video Frame Rate	HDCVI: 1~25f/s (PAL) ; 1~30f/s (NTSC) CVBS: 1~25f/s (PAL) ; 1~30f/s (NTSC)		
	Video Bit Rate	2048Kbps-4096Kbps, For 1080P/720P: default setup is 2Mbps, max supports 4Mbps. For 960H: default setup is 1Mbps, max supports 3Mbps.		
	Bit Stream Type	Video stream/composite stream		
	Dual-Stream	Support		

	Parameters	HCVR5104H-S2	HCVR5108H-S2	HCVR5116H-S2
Audio Parameters	Encode Standard	G.711A/G.711U/PCM		
	Audio Sampling Rate	8KHz,16Bit		
	Audio Bit Rate	64Kbps		
Video Port	Analog Video Input	4-channel,BNC port	8-channel,BNC port	16-channel, BNC port
	Network Video Input	Max 2-channel IPC connections (8M)		
	Video Output	1-channel VGA output, 1-channel HDMI output (of the same video source), HDMI/ VGA video output at the same time.		
	Loop Output	N/A		
	Matrix Output	N/A		
Audio Port	Audio Input	1-channel RCA port.		
	Audio Output	1-channel RCA port.		
	Bidirectional Talk Input	Reuse the audio input/output port.		
Record	Record Mode	Schedule record/manual record/MD record/Alarm record		
	Record Playback	Max 4-channel playback	Max 8-channel playback	Max 16-channel playback
	Backup Mode	HDD, burner, USB device, network backup		
Alarm	Alarm Input	N/A		
	Alarm Output	N/A		
HDD	HDD Port	1 SATA port,does not support eSATA port		
	One HDD Space	4T		
Communication Port	Network	1 RJ45 port, 100Mbps Ethernet port		
	Communication	RS485 port		
	USB	2 USB ports		
Others	Power	DC12V		
	Power Consumption	≤15W (With power adapter, no HDD)		
	Working Temperature	-10℃~+55℃		
	Working Humidity	10%~90%		
	Dimensions	Mini 1U case,325mm (W) x245mm (D) x45mm (H)		
	Weight	1.25KG (No HDD)		
	Installation Mode	Desk		

1.3.22 HCVR51XXHE-S2 Series

	Parameters	HCVR5104HE-S2	HCVR5108HE-S2	HCVR5116HE-S2
System	Main Processor	Industrial embedded micro controller		
	OS	Embedded LINUX		
Video Parameters	Video Encode Standard	H.264		
	Encode Resolution	1080P(1~15fps)/720P/960H/D1/HD1/2CIF/CIF/QCIF		
	Video Frame Rate	HDCVI:1~25f/s (PAL) ; 1~30f/s (NTSC) CVBS:1~25f/s (PAL) ; 1~30f/s (NTSC)		
	Video Bit Rate	2048Kbps-4096Kbps, For 1080P/720P: default setup is 2Mbps,max supports 4Mbps. For 960H: default setup is 1Mbps,max supports 3Mbps.		
	Bit Stream Type	Video stream/composite stream		
	Dual-Stream	Support		
Audio Parameters	Encode Standard	G.711A/G.711U/PCM		
	Audio Sampling Rate	8KHz,16Bit		
	Audio Bit Rate	64Kbps		
Video Port	Analog Video Input	4-channel,BNC port	8-channel,BNC port	16-channel, BNC port
	Network Video Input	Max 2-channel IPC connections (8M)		
	Video Output	1-channel VGA output, 1-channel HDMI output (of the same video source), HDMI/ VGA video output at the same time.		
	Loop Output	N/A		
	Matrix Output	N/A		
Audio Port	Audio Input	4-channel RCA port.		
	Audio Output	1-channel RCA port.		
	Bidirectional Talk Input	Reuse the audio input/output port.		
Record	Record Mode	Schedule record/manual record/MD record/Alarm record		
	Record Playback	Max 4-channel playback	Max 8-channel playback	Max 16-channel playback
	Backup Mode	HDD, burner, USB device, network backup		
Alarm	Alarm Input	4-channel input	8-channel input	16-channel input
	Alarm Output	3-channel output		
HDD	HDD Port	1 SATA port,does not support eSATA port		
	One HDD Space	4T		
Communication Port	Network	1 RJ45 port, 100Mbps Ethernet port		
	Communication	RS485 port		

	Parameters	HCVR5104HE-S2	HCVR5108HE-S2	HCVR5116HE-S2
	USB	2 USB ports		
Others	Power	DC12V		
	Power Consumption	≤15W (With power adapter, no HDD)		
	Working Temperature	-10℃~+55℃		
	Working Humidity	10%~90%		
	Dimensions	Mini 1U case,325mm (W) x245mm (D) x45mm (H)		
	Weight	1.25KG (No HDD)		
	Installation Mode	Desk		

1.3.23 HCVR710XH-S2 Series

	Parameters	HCVR7104H-S2	HCVR7108H-S2
System	Main Processor	Industrial embedded micro controller	
	OS	Embedded LINUX	
Video Parameters	Video Encode Standard	H.264	
	Encode Resolution	1080P/720P/960H/D1/HD1/2CIF/CIF/QCIF	
	Video Frame Rate	HDCVI:1~25f/s (PAL) ; 1~30f/s (NTSC) CVBS:1~25f/s (PAL) ; 1~30f/s (NTSC)	
	Video Bit Rate	2048Kbps-6144Kbps, For 1080P: default setup is 4Mbps,max supports 6Mbps. For 720P: default setup is 2Mbps,max supports 4Mbps.	
	Bit Stream Type	Video stream/composite stream	
	Dual-Stream	Support	
Audio Parameters	Encode Standard	G.711A/G.711U/PCM	
	Audio Sampling Rate	8KHz,16Bit	
	Audio Bit Rate	64Kbps	
Video Port	Analog Video Input	4-channel,BNC port	8-channel,BNC port
	Network Video Input	Max 2-channel IPC connections (16M)	
	Video Output	1-channel VGA output, 1-channel HDMI output (of the same video source), HDMI/ VGA video output at the same time.	
	Loop Output	N/A	
	Matrix Output	N/A	

	Parameters	HCVR7104H-S2	HCVR7108H-S2
Audio Port	Audio Input	1-channel RCA port.	
	Audio Output	1-channel RCA port.	
	Bidirectional Talk Input	Reuse the audio input/output port.	
Record	Record Mode	Schedule record/manual record/MD record/Alarm record	
	Record Playback	Max 4-channel playback	Max 8-channel playback
	Backup Mode	HDD, burner, USB device, network backup	
Alarm	Alarm Input	N/A	
	Alarm Output	N/A	
HDD	HDD Port	1 SATA port, does not support eSATA port	
	One HDD Space	4T	
Communication Port	Network	1 RJ45 port, 100Mbps Ethernet port	
	Communication	RS485 port	
	USB	2 USB ports	
Others	Power	DC12V	
	Power Consumption	≤15W (With power adapter, no HDD)	
	Working Temperature	-10°C ~ +55°C	
	Working Humidity	10%~90%	
	Dimensions	Mini 1U case, 325mm (W) x 245mm (D) x 45mm (H)	
	Weight	1.25KG (No HDD)	
	Installation Mode	Desk	

1.3.24 HCVR710XHE-S2 Series

	Parameters	HCVR7104HE-S2	HCVR7108HE-S2
System	Main Processor	Industrial embedded micro controller	
	OS	Embedded LINUX	
Video Parameters	Video Encode Standard	H.264	
	Encode Resolution	1080P/720P/960H/D1/HD1/2CIF/CIF/QCIF	
	Video Frame Rate	HDCVI: 1~25f/s (PAL) ; 1~30f/s (NTSC) CVBS: 1~25f/s (PAL) ; 1~30f/s (NTSC)	
	Video Bit Rate	2048Kbps-6144Kbps, For 1080P: default setup is 4Mbps, max supports 6Mbps. For 720P: default setup is 2Mbps, max supports 4Mbps.	
	Bit Stream Type	Video stream/composite stream	
	Dual-Stream	Support	

	Parameters	HCVR7104HE-S2	HCVR7108HE-S2
Audio Parameters	Encode Standard	G.711A/G.711U/PCM	
	Audio Sampling Rate	8KHz,16Bit	
	Audio Bit Rate	64Kbps	
Video Port	Analog Video Input	4-channel,BNC port	8-channel,BNC port
	Network Video Input	Max 2-channel IPC connection (16M)	
	Video Output	1-channel VGA output, 1-channel HDMI output (of the same video source), HDMI/ VGA video output at the same time.	
	Loop Output	N/A	
	Matrix Output	N/A	
Audio Port	Audio Input	4-channel RCA port.	
	Audio Output	1-channel RCA port.	
	Bidirectional Talk Input	Reuse the audio input/output port.	
Record	Record Mode	Schedule record/manual record/MD record/Alarm record	
	Record Playback	Max 4-channel playback	Max 8-channel playback
	Backup Mode	HDD, burner, USB device, network backup	
Alarm	Alarm Input	8-channel input	16-channel input
	Alarm Output	3-channel output	
HDD	HDD Port	1 SATA port,does not support eSATA port	
	One HDD Space	4T	
Communication Port	Network	1 RJ45 port, 100Mbps Ethernet port	
	Communication	RS485 port	
	USB	2 USB ports	
Others	Power	DC12V	
	Power Consumption	≤15W (With power adapter, no HDD)	
	Working Temperature	-10℃~+55℃	
	Working Humidity	10%~90%	
	Dimensions	Mini 1U case,325mm (W) x245mm (D) x45mm (H)	
	Weight	1.25KG (No HDD)	
	Installation Mode	Desk	

1.3.25 HCVR41XXHE-S3 Series

	Parameters	HCVR4104HE-S3	HCVR4108HE-S3	HCVR4116HE-S3
System	Main Processor	Industrial embedded micro controller		
	OS	Embedded LINUX		
Video Parameters	Video Encode Standard	H.264		
	Encode Resolution	1080N/720P/960H/D1/HD1/2CIF/CIF	1080N@12f/720P@15f/960H/D1/HD1/2CIF/CIF	
	Video Frame Rate	PAL:1~25f/s; NTSC:1~30f/s		
	Video Bit Rate	32Kbps-4096Kbps, For 720P: default setup is 1.5Mbps,max supports 4Mbps. For 1080P: default setup is 1.5Mbps,max supports 4Mbps.		
	Bit Stream Type	Video stream/composite stream		
	Dual-Stream	Support		
Audio Parameters	Encode Standard	G.711A/G.711U/PCM		
	Audio Sampling Rate	8KHz,16Bit		
	Audio Bit Rate	64Kbps		
Video Port	Analog Video Input	4-ch BNC port (HDCVI HD video/general standard definition video self-adaptive)	8-ch BNC port(HDCVI HD video/general standard definition video self-adaptive)	16-ch BNC port(HDCVI HD video/general standard definition video self-adaptive)
	Network Video Input	<ul style="list-style-type: none"> ● Max add 1 IP channel Connection. ● Analog /digital channel switch. Max 5 IP channel connections ● Connection bandwidth:4Mbps-20Mbps 	<ul style="list-style-type: none"> ● Max add 2 IP channel connections ● Analog /digital channel switch. Max 10 IP channel connections ● Connection bandwidth:8Mbps-40Mbps 	<ul style="list-style-type: none"> ● Max add 2 IP channel connections ● Analog /digital channel switch. Max 18 IP channel connections ● Connection bandwidth:8Mbps-56Mbps
	Video Output	1-channel VGA output, 1-channel HDMI output (of the same video source), HDMI/ VGA video output at the same time.		
	Loop Output	N/A		

	Parameters	HCVR4104HE-S3	HCVR4108HE-S3	HCVR4116HE-S3
	Matrix Output	N/A		
Audio Port	Audio Input	4-channel RCA port.	8-channel RCA port.	16-channel RCA port.
	Coaxial Audio Input	4-ch	8-ch-	16-ch
	Audio Output	1-channel RCA port.		
	Bidirectional Talk Input	Support (Reuse the audio port of the 1st channel)		
Record	Record Mode	Schedule record/manual record/MD record/Alarm record		
	Playback Mode	Instant playback, normal playback, event playback, mark playback, smart playback		
	Record Playback	Max 4-channel playback	Max 8-channel playback	Max 16-channel playback
	Backup Mode	HDD, burner, USB device, network backup		
Alarm	Alarm Input	8-channel input	8-channel input	16-channel input
	Alarm Output	3-channel output		
HDD	HDD Port	1 SATA port, does not support eSATA port		
	One HDD Space	6T		
Communication Port	Network	1 RJ45 port, 100Mbps Ethernet port		
	Communication	RS485 port		
	USB	2 USB2.0 ports(One at the front panel and one at the rear panel)		
Others	Power	DC12V		
	Power Consumption	≤7W	≤8W	≤10W
	Working Temperature	-10℃~+55℃		
	Working Humidity	10%~90%		
	Dimensions	Mini 1U case, 325mm (W) ×245mm (D) ×45mm (H)		
	Weight	≤1.1KG	≤1.25KG	≤1.45KG
	Installation Mode	Desk		

1.3.26 HCVR51XXH-S3 Series

	Parameters	HCVR5104HS3	HCVR5108H-S3	HCVR5116H-S3
System	Main Processor	Industrial embedded micro controller		
	OS	Embedded LINUX		
Video Parameters	Video Encode Standard	H.264		
	Encode Resolution	1080P (non-realtime) /1080N/720P /720P/960H/D1/HD1/2CIF/CIF		

	Parameters	HCVR5104HS3	HCVR5108H-S3	HCVR5116H-S3
	Video Frame Rate	PAL:1~25f/s; NTSC:1~30f/s		
	Video Bit Rate	32Kbps-6144Kbps, For 720P: default setup is 2Mbps,max supports 4Mbps. For 1080P: default setup is 4Mbps,max supports 6Mbps.		
	Bit Stream Type	Video stream/composite stream		
	Dual-Stream	Support		
Audio Parameters	Encode Standard	G.711A/G.711U/PCM		
	Audio Sampling Rate	8KHz,16Bit		
	Audio Bit Rate	64Kbps		
Video Port	Analog Video Input	4-ch BNC port (HDCVI HD video/general standard definition video self-adaptive)	8-ch BNC port(HDCVI HD video/general standard definition video self-adaptive)	16-ch BNC port(HDCVI HD video/general standard definition video self-adaptive)
	Network Video Input	<ul style="list-style-type: none"> ● Max add 2 IP channel Connection. ● Analog /digital channel switch. Max 6 IP channel connections ● Connection bandwidth:8Mbps-24Mbps 	<ul style="list-style-type: none"> ● Max add 4 IP channel connections ● Analog /digital channel switch. Max 12IP channel connections ● Connection bandwidth:16Mbps-48Mbps 	<ul style="list-style-type: none"> ● Max add 8 IP channel connections ● Analog /digital channel switch. Max 24 IP channel connections ● Connection bandwidth:32Mbps-96Mbps
	Video Output	1-channel VGA output, 1-channel HDMI output (of the same video source), HDMI/ VGA video output at the same time.		
	Loop Output	N/A		
	Matrix Output	N/A		
	Audio Port	Audio Input	1-channel RCA port.	
Coaxial Audio Input		4-ch	8-ch-	16-ch
Audio Output		1-channel RCA port.		
Bidirectional Talk Input		Support (Reuse the audio port of the 1st channel)		

	Parameters	HCVR5104HS3	HCVR5108H-S3	HCVR5116H-S3
Record	Record Mode	Schedule record/manual record/MD record/Alarm record		
	Playback Mode	Instant playback, normal playback, event playback, mark playback, smart playback		
	Record Playback	Max 4-channel playback	Max 8-channel playback	Max 16-channel playback
	Backup Mode	HDD, burner, USB device, network backup		
Alarm	Alarm Input	8-channel input	8-channel input	16-channel input
	Alarm Output	3-channel output		
HDD	HDD Port	1 SATA port, does not support eSATA port		
	One HDD Space	6T		
Communication Port	Network	1 RJ45 port, 100Mbps Ethernet port		
	Communication	RS485 port		
	USB	2 USB2.0 ports (One at the front panel and one at the rear panel)	1 USB2.0 port at the front panel and one USB3.0 port at the rear panel	1 USB2.0 port at the front panel and one USB3.0 port at the rear panel
Others	Power	DC12V		
	Power Consumption	≤8W	≤10W	≤15W
	Working Temperature	-10°C ~ +55°C		
	Working Humidity	10%~90%		
	Dimensions	Mini 1U case, 325mm (W) × 245mm (D) × 45mm (H)		
	Weight	≤1.1KG	≤1.25KG	≤1.45KG
	Installation Mode	Desk		

1.3.27 HCVR51XXHE-S3 Series

	Parameters	HCVR5104HE-S3	HCVR5108HE-S3	HCVR5116HE-S3
System	Main Processor	Industrial embedded micro controller		
	OS	Embedded LINUX		
Video Parameters	Video Encode Standard	H.264		
	Encode Resolution	1080P@12f/720P@15f/960H/D1/HD1/2CIF/CIF		
	Video Frame Rate	PAL:1~25f/s; NTSC:1~30f/s		
	Video Bit Rate	32Kbps-6144Kbps, For 720P: default setup is 2Mbps, max supports 4Mbps.		

	Parameters	HCVR5104HE-S3	HCVR5108HE-S3	HCVR5116HE-S3
		For 1080P: default setup is 2Mbps,max supports 6Mbps.		
	Bit Stream Type	Video stream/composite stream		
	Dual-Stream	Support		
Audio Parameters	Encode Standard	G.711A/G.711U/PCM		
	Audio Sampling Rate	8KHz,16Bit		
	Audio Bit Rate	64Kbps		
Video Port	Analog Video Input	4-ch BNC port (HDCVI HD video/general standard definition video self-adaptive)	8-ch BNC port(HDCVI HD video/general standard definition video self-adaptive)	16-ch BNC port(HDCVI HD video/general standard definition video self-adaptive)
	Network Video Input	<ul style="list-style-type: none"> ● Max add 2 IP channel Connection. ● Analog /digital channel switch. Max 6 IP channel connections ● Connection bandwidth:8Mbps-24Mbps 	<ul style="list-style-type: none"> ● Max add 4 IP channel connections ● Analog /digital channel switch. Max 12IP channel connections ● Connection bandwidth:16Mbps-48Mbps 	<ul style="list-style-type: none"> ● Max add 8 IP channel connections ● Analog /digital channel switch. Max 24 IP channel connections ● Connection bandwidth:32 Mbps-96Mbps
	Video Output	1-channel VGA output, 1-channel HDMI output (of the same video source), HDMI/ VGA video output at the same time.		
	Loop Output	N/A		
	Matrix Output	N/A		
Audio Port	Audio Input	4-channel RCA port.	8-channel RCA port.	16-channel RCA port.
	Coaxial Audio Input	4-ch	8-ch-	16-ch
	Audio Output	1-channel RCA port.		
	Bidirectional Talk Input	Support (Reuse the audio port of the 1st channel)		
Record	Record Mode	Schedule record/manual record/MD record/Alarm record		
	Playback Mode	Instant playback, normal playback, event playback, mark playback, smart playback		

	Parameters	HCVR5104HE-S3	HCVR5108HE-S3	HCVR5116HE-S3
	Record Playback	Max 4-channel playback	Max 8-channel playback	Max 16-channel playback
	Backup Mode	HDD, burner, USB device, network backup		
Alarm	Alarm Input	8-channel input	8-channel input	16-channel input
	Alarm Output	3-channel output		
HDD	HDD Port	1 SATA port, does not support eSATA port		
	One HDD Space	6T		
Communication Port	Network	1 RJ45 port, 100Mbps Ethernet port		
	Communication	RS485 port		
	USB	2 USB2.0 ports(One at the front panel and one at the rear panel)		
Others	Power	DC12V		
	Power Consumption	≤7W	≤8W	≤10W
	Working Temperature	-10℃~+55℃		
	Working Humidity	10%~90%		
	Dimensions	Mini 1U case, 325mm (W) x 245mm (D) x 45mm (H)		
	Weight	≤1.1KG	≤1.25KG	≤1.45KG
	Installation Mode	Desk		

1.3.28 HCVR71XXHE-S3 Series

	Parameters	HCVR7104HE-S3	HCVR7108HE-S3	HCVR7116HE-S3
System	Main Processor	Industrial embedded micro controller		
	OS	Embedded LINUX		
Video Parameters	Video Encode Standard	H.264		
	Encode Resolution	1080P/720P/960H/D1/HD1/2CIF/CIF		
	Video Frame Rate	PAL:1~25f/s; NTSC:1~30f/s		
	Video Bit Rate	32Kbps-6144Kbps, For 720P: default setup is 2Mbps, max supports 4Mbps. For 1080P: default setup is 4Mbps, max supports 6Mbps.		
	Bit Stream Type	Video stream/composite stream		
	Dual-Stream	Support		
Audio Parameters	Encode Standard	G.711A/G.711U/PCM		
	Audio Sampling Rate	8KHz, 16Bit		

	Parameters	HCVR7104HE-S3	HCVR7108HE-S3	HCVR7116HE-S3
	Audio Bit Rate	64Kbps		
Video Port	Analog Video Input	4-ch BNC port (HDCVI HD video/general standard definition video self-adaptive)	8-ch BNC port(HDCVI HD video/general standard definition video self-adaptive)	16-ch BNC port(HDCVI HD video/general standard definition video self-adaptive)
	Network Video Input	<ul style="list-style-type: none"> ● Max add 2 IP channel Connection. ● Analog /digital channel switch. Max 6 IP channel connections ● Connection bandwidth:8Mbps-24Mbps 	<ul style="list-style-type: none"> ● Max add 4 IP channel connections ● Analog /digital channel switch. Max 12IP channel connections ● Connection bandwidth:16Mbps-48Mbps 	<ul style="list-style-type: none"> ● Max add 8 IP channel connections ● Analog /digital channel switch. Max 24 IP channel connections ● Connection bandwidth:32 Mbps-96Mbps
	Video Output	1-channel VGA output, 1-channel HDMI output (of the same video source), HDMI/ VGA video output at the same time.		
	Loop Output	N/A		
	Matrix Output	N/A		
Audio Port	Audio Input	4-channel RCA port.	8-channel RCA port.	16-channel RCA port.
	Coaxial Audio Input	4-ch	8-ch-	16-ch
	Audio Output	1-channel RCA port.		
	Bidirectional Talk Input	Support (Reuse the audio port of the 1st channel)		
Record	Record Mode	Schedule record/manual record/MD record/Alarm record		
	Playback Mode	Instant playback, normal playback, event playback, mark playback, smart playback		
	Record Playback	Max 4-channel playback	Max 8-channel playback	Max 16-channel playback
	Backup Mode	HDD, burner, USB device, network backup		
Alarm	Alarm Input	8-channel input	8-channel input	16-channel input
	Alarm Output	3-channel output		
HDD	HDD Port	1 SATA port,does not support eSATA port		
	One HDD Space	6T		

	Parameters	HCVR7104HE-S3	HCVR7108HE-S3	HCVR7116HE-S3
Communication Port	Network	1 RJ45 port, 100Mbps Ethernet port		
	Communication	RS485 port		
	USB	2 USB2.0 ports(One at the front panel and one at the rear panel)	1 USB2.0 port at the front panel and one USB3.0 port at the rear panel	1 USB2.0 port at the front panel and one USB3.0 port at the rear panel
Others	Power	DC12V		
	Power Consumption	≤8W	≤10W	≤15W
	Working Temperature	-10℃~+55℃		
	Working Humidity	10%~90%		
	Dimensions	Mini 1U case,325mm (W) ×245mm (D) ×45mm (H)		
	Weight	≤1.1KG	≤1.25KG	≤1.45KG
	Installation Mode	Desk		

1.3.29 HCVR71XXH-S3 Series

	Parameters	HCVR7104HS3	HCVR7108H-S3	HCVR7116H-S3
System	Main Processor	Industrial embedded micro controller		
	OS	Embedded LINUX		
Video Parameters	Video Encode Standard	H.264		
	Encode Resolution	1080P/720P/960H/D1/HD1/2CIF/CIF		
	Video Frame Rate	PAL:1~25f/s; NTSC:1~30f/s		
	Video Bit Rate	32Kbps-6144Kbps, For 720P: default setup is 2Mbps,max supports 4Mbps. For 1080P: default setup is 4Mbps,max supports 6Mbps.		
	Bit Stream Type	Video stream/composite stream		
	Dual-Stream	Support		
Audio Parameters	Encode Standard	G.711A/G.711U/PCM		
	Audio Sampling Rate	8KHz,16Bit		
	Audio Bit Rate	64Kbps		
Video Port	Analog Video Input	4-ch BNC port (HDCVI HD video/general	8-ch BNC port(HDCVI HD video/general standard definition	16-ch BNC port(HDCVI HD video/general

	Parameters	HCVR7104HS3	HCVR7108H-S3	HCVR7116H-S3
		standard definition video self-adaptive)	video self-adaptive)	standard definition video self-adaptive)
	Network Video Input	<ul style="list-style-type: none"> ● Max add 2 IP channel Connection. ● Analog /digital channel switch. Max 6 IP channel connections ● Connection bandwidth:8Mbps-24Mbps 	<ul style="list-style-type: none"> ● Max add 4 IP channel connections ● Analog /digital channel switch. Max 12IP channel connections ● Connection bandwidth:16Mbps-48Mbps 	<ul style="list-style-type: none"> ● Max add 8 IP channel connections ● Analog /digital channel switch. Max 24 IP channel connections ● Connection bandwidth:32Mbps-96Mbps
	Video Output	1-channel VGA output, 1-channel HDMI output (of the same video source), HDMI/ VGA video output at the same time.		
	Loop Output	N/A		
	Matrix Output	N/A		
Audio Port	Audio Input	4-channel RCA port.	8-channel RCA port.	16-channel RCA port.
	Coaxial Audio Input	4-ch	8-ch-	16-ch
	Audio Output	1-channel RCA port.		
	Bidirectional Talk Input	Support (Reuse the audio port of the 1st channel)		
Record	Record Mode	Schedule record/manual record/MD record/Alarm record		
	Playback Mode	Instant playback, normal playback, event playback, mark playback, smart playback		
	Record Playback	Max 4-channel playback	Max 8-channel playback	Max 16-channel playback
	Backup Mode	HDD, burner, USB device, network backup		
Alarm	Alarm Input	8-channel input	8-channel input	16-channel input
	Alarm Output	3-channel output		
HDD	HDD Port	1 SATA port,does not support eSATA port		
	One HDD Space	6T		
Communication Port	Network	1 RJ45 port, 100Mbps Ethernet port		
	Communication	RS485 port		
	USB	2 USB2.0 ports(One at the front panel and	1 USB2.0 port at the front panel and one	1 USB2.0 port at the front panel

	Parameters	HCVR7104HS3	HCVR7108H-S3	HCVR7116H-S3
		one at the rear panel)	USB3.0 port at the rear panel	and one USB3.0 port at the rear panel
Others	Power	DC12V		
	Power Consumption	≤8W	≤10W	≤15W
	Working Temperature	-10℃~+55℃		
	Working Humidity	10%~90%		
	Dimensions	Mini 1U case,325mm (W) ×245mm (D) ×45mm (H)		
	Weight	≤1.1KG	≤1.25KG	≤1.45KG
	Installation Mode	Desk		

1.3.30 HCVR41XXHS-S2 Series

	Parameters	HCVR4104HS-S2	HCVR4108HS-S2	HCVR4116HS-S2
System	Main Processor	Industrial embedded micro controller		
	OS	Embedded LINUX		
Video Parameters	Video Encode Standard	H.264		
	Encode Resolution	720P/960H/D1/HD1/2CIF/CIF/QCIF	720P(1-15f/s)/960H/D1/HD1/2CIF/CIF/QCIF	
	Video Frame Rate	HDCVI:1~25f/s(PAL); 1~30f/s (NTSC) CVBS:1~25f/s (PAL) ; 1~30f/s (NTSC)	HDCVI:1 ~ 15f/s (The 1 st channel supports 25/30fps/) CVBS:1~25f/s (PAL) ; 1~30f/s (NTSC)	
	Video Bit Rate	2048Kbps-4096Kbps, For 720P: default setup is 2Mbps,max supports 4Mbps. For 960H: default setup is 1Mbps,max supports 3Mbps.	1024Kbps-4096Kbps, For 720P: default setup is 1Mbps,max supports 4Mbps. For 960H: default setup is 1Mbps,max supports 3Mbps.	
	Bit Stream Type	Video stream/composite stream		
	Dual-Stream	Support		
Audio Parameters	Encode Standard	G.711A/G.711U/PCM		
	Audio Sampling Rate	8KHz,16Bit		
	Audio Bit Rate	64Kbps		
Video Port	Analog Video	4-channel,BNC port	8-channel,BNC port	16-channel,

	Parameters	HCVR4104HS-S2	HCVR4108HS-S2	HCVR4116HS-S2
	Input			BNC port
	Network Video Input	Max 2-channel IPC connections (8M)		
	Video Output	1-channel VGA output, 1-channel HDMI output (of the same video source), HDMI/ VGA video output at the same time.		
	Loop Output	N/A		
	Matrix Output	N/A		
Audio Port	Audio Input	1-channel RCA port.		
	Audio Output	1-channel RCA port.		
	Bidirectional Talk Input	Reuse the audio input/output port.		
Record	Record Mode	Schedule record/manual record/MD record/Alarm record		
	Record Playback	Max 4-channel playback	Max 8-channel playback	Max 16-channel playback
	Backup Mode	HDD, burner, USB device, network backup		
Alarm	Alarm Input	N/A		
	Alarm Output	N/A		
HDD	HDD Port	1 SATA port, does not support eSATA port		
	One HDD Space	4T		
Communication Port	Network	1 RJ45 port, 100Mbps Ethernet port		
	Communication	RS485 port		
	USB	2 USB ports		
Others	Power	DC12V		
	Power Consumption	≤15W (With power adapter, no HDD)		
	Working Temperature	-10℃~+55℃		
	Working Humidity	10%~90%		
	Dimensions	Compact 1U case, 260mm (W) x220mm (D) x44mm (H)		
	Weight	1.25KG (No HDD)		
	Installation Mode	Desk		

1.3.31 HCVR21XXHS-S2 Series

	Parameters	HCVR2108HS-S2	HCVR2116HS-S2
System	Main Processor	Industrial embedded micro controller	
	OS	Embedded LINUX	
Video Parameters	Video Encode Standard	H.264	
	Encode	720P(1-15f/s)/960H/D1/HD1/2CIF/CIF/QCIF	

	Parameters	HCVR2108HS-S2	HCVR2116HS-S2
	Resolution		
	Video Frame Rate	HDCVI:1~12f/s CVBS:1~20f/s (PAL) ; 1~20f/s (NTSC)	
	Video Bit Rate	1024Kbps-4096Kbps, For 720P: default setup is 1Mbps,max supports 4Mbps. For 960H: default setup is 1Mbps,max supports 3Mbps.	
	Bit Stream Type	Video stream/composite stream	
	Dual-Stream	Support	
Audio Parameters	Encode Standard	G.711A/G.711U/PCM	
	Audio Sampling Rate	8KHz,16Bit	
	Audio Bit Rate	64Kbps	
Video Port	Analog Video Input	8-channel,BNC port	16-channel,BNC port
	Video Output	1-channel VGA output, 1-channel HDMI output (of the same video source), HDMI/ VGA video output at the same time.	
	Loop Output	N/A	
	Matrix Output	N/A	
Audio Port	Audio Input	1-channel RCA port.	
	Audio Output	1-channel RCA port.	
	Bidirectional Talk Input	Reuse the audio input/output port.	
Record	Record Mode	Schedule record/manual record/MD record/Alarm record	
	Record Playback	960H: Max 4-channel playback 720P: Max 1-channel playback	
	Backup Mode	HDD, burner, USB device, network backup	
Alarm	Alarm Input	N/A	
	Alarm Output	N/A	
HDD	HDD Port	1 SATA port,does not support eSATA port	
	One HDD Space	4T	
Communication Port	Network	1 RJ45 port, 100Mbps Ethernet port	
	Communication	RS485 port	
	USB	2 USB ports	
Others	Power	DC12V	
	Power Consumption	≤15W (With power adapter, no HDD)	
	Working Temperature	-10℃~+55℃	
	Working	10%~90%	

	Parameters	HCVR2108HS-S2	HCVR2116HS-S2
	Humidity		
	Dimensions	Compact 1U case, 260mm (W) x220mm (D) x44mm (H)	
	Weight	1.25KG (No HDD)	
	Installation Mode	Desk	

1.3.32 HCVR21XXHS-S3 Series

	Parameters	2104HS-S3	2108HS-S3	2116HS-S3
System	Main Processor	Industrial embedded micro controller		
	OS	Embedded LINUX		
Video Parameters	Video Encode Standard	H.264		
	Encode Resolution	1080N@12f/720P@15f/960H/D1/HD1/2CIF/CIF		
	Video Frame Rate	PAL:1~25f/s; NTSC:1~30f/s		
	Video Bit Rate	32Kbps-4096Kbps, For 720P: default setup is 1.5Mbps,max supports 4Mbps. For 1080N: default setup is 1.5Mbps,max supports 4Mbps.		
	Bit Stream Type	Video stream/composite stream		
	Dual-Stream	Support		
Audio Parameters	Encode Standard	G.711A/G.711U/PCM		
	Audio Sampling Rate	8KHz,16Bit		
	Audio Bit Rate	64Kbps		
Video Port	Analog Video Input	4-ch BNC port(HDCVI HD video/general standard definition video self-adaptive)	8-ch BNC port(HDCVI HD video/general standard definition video self-adaptive)	16-ch BNC port(HDCVI HD video/general standard definition video self-adaptive)
	Network Video Input	Analog/digital channel switch. Max 2 IP channel connections Connection bandwidth:8Mbps		
	Video Output	1-channel VGA output, 1-channel HDMI output (of the same video source), HDMI/ VGA video output at the same time.		
	Loop Output	N/A		
	Matrix Output	N/A		
Audio Port	Audio Input	1-channel RCA port.		
	Coaxial Audio Input	4-ch	8-ch	16-ch

	Parameters	2104HS-S3	2108HS-S3	2116HS-S3
	Audio Output	1-channel RCA port.		
	Bidirectional Talk Input	Reuse the audio input/output port of the 1st channel.		
Record	Record Mode	Schedule record/manual record/MD record/Alarm record		
	Playback Mode	Instant playback, normal playback, event playback, mark playback, smart playback		
	Backup Mode	HDD, burner, USB device, network backup		
Alarm	Alarm Input	N/A		
	Alarm Output	N/A		
HDD	HDD Port	1 SATA port, does not support eSATA port		
	One HDD Space	6T		
Communication Port	Network	1 RJ45 port, 100Mbps Ethernet port		
	Communication	RS485 port		
	USB	2 USB2.0 ports(One at the front panel and one at the rear panel)		
Others	Power	DC12V		
	Power Consumption (No HDD)	≤10W		
	Working Temperature	-10℃~+55℃		
	Working Humidity	10%~90%		
	Dimensions	Compact 1U case, 260mm (W) x220mm (D) x44mm (H)		
	Weight (No HDD)	≤1.25KG	≤1.35KG	≤1.45KG
	Installation Mode	Desk		

1.3.33 HCVR41XXHS-S3 Series

	Parameters	HCVR4104HS-S3	HCVR4108HS-S3	HCVR4116HS-S3
System	Main Processor	Industrial embedded micro controller		
	OS	Embedded LINUX		
Video Parameters	Video Encode Standard	H.264		
	Encode Resolution	1080N/720P/960H/D1 /HD1/2CIF/CIF/	1080N@12f/720P@15f/960H/D1/HD1/2CI F/CIF/	
	Video Frame Rate	PAL:1~25f/s; NTSC:1~30f/s		
	Video Bit Rate	32Kbps-4096Kbps, For 720P: default setup is 1.5Mbps,max supports 4Mbps. For 1080P: default setup is 1.5Mbps,max supports 4Mbps.		

	Parameters	HCVR4104HS-S3	HCVR4108HS-S3	HCVR4116HS-S3
	Bit Stream Type	Video stream/composite stream		
	Dual-Stream	Support		
Audio Parameters	Encode Standard	G.711A/G.711U/PCM		
	Audio Sampling Rate	8KHz,16Bit		
	Audio Bit Rate	64Kbps		
Video Port	Analog Video Input	4-ch BNC port (HDCVI HD video/general standard definition video self-adaptive)	8-ch BNC port(HDCVI HD video/general standard definition video self-adaptive)	16-ch BNC port(HDCVI HD video/general standard definition video self-adaptive)
	Network Video Input	<ul style="list-style-type: none"> ● Max add 1 IP channel connection ● Analog /digital channel switch. Max 5 IP channel connections ● Connection bandwidth:4Mbps-20Mbps 	<ul style="list-style-type: none"> ● Max add 1 IP channel connection ● Analog /digital channel switch. Max 9 IP channel connections ● Connection bandwidth:8Mbps-40Mbps 	<ul style="list-style-type: none"> ● Max add 2 IP channel connections ● Analog /digital channel switch. Max 18 IP channel connections ● Connection bandwidth:8Mbps-56Mbps
	Video Output	1-channel VGA output, 1-channel HDMI output (of the same video source), HDMI/ VGA video output at the same time.		
	Loop Output	N/A		
	Matrix Output	N/A		
Audio Port	Audio Input	1-channel RCA port.		
	Coaxial Audio Input	4-ch	8-ch-	16-ch
	Audio Output	1-channel RCA port.		
	Bidirectional Talk Input	Reuse the audio input/output port.		
Record	Record Mode	Schedule record/manual record/MD record/Alarm record		
	Playback Mode	Instant playback, normal playback, event playback, mark playback, smart playback		
	Record Playback	Max 4-channel playback	Max 8-channel playback	Max 16-channel playback

	Parameters	HCVR4104HS-S3	HCVR4108HS-S3	HCVR4116HS-S3
	Backup Mode	HDD, burner, USB device, network backup		
Alarm	Alarm Input	N/A		
	Alarm Output	N/A		
HDD	HDD Port	1 SATA port, does not support eSATA port		
	One HDD Space	6T		
Communication Port	Network	1 RJ45 port, 100Mbps Ethernet port		
	Communication	RS485 port		
	USB	2 USB2.0 ports(One at the front panel and one at the rear panel)		
Others	Power	DC12V		
	Power Consumption (No HDD)	≤7W	≤8W	≤10W
	Working Temperature	-10°C ~ +55°C		
	Working Humidity	10%~90%		
	Dimensions	Compact 1U case, 260mm (W) x220mm (D) x44mm (H)		
	Weight (No HDD)	≤0.85KG	≤0.95KG	≤1.05KG
	Installation Mode	Desk		

1.3.34 HCVR51XXHS-S3 Series

	Parameters	HCVR5104HS-S3	HCVR5108HS-S3	HCVR5116HS-S3
System	Main Processor	Industrial embedded micro controller		
	OS	Embedded LINUX		
Video Parameters	Video Encode Standard	H.264		
	Encode Resolution	1080P@15f/1080N/720P/960H/D1/HD1/2CIF/CIF/1080P@15f/720P@15f/960H/D1/HD1/2CIF/CIF		
	Video Frame Rate	PAL:1~25f/s; NTSC:1~30f/s		
	Video Bit Rate	32Kbps-6144Kbps, For 720P: default setup is 2Mbps,max supports 4Mbps. For 1080P: default setup is 2Mbps,max supports 6Mbps.		
	Bit Stream Type	Video stream/composite stream		
	Dual-Stream	Support		
Audio Parameters	Encode Standard	G.711A/G.711U/PCM		
	Audio Sampling Rate	8KHz,16Bit		

	Parameters	HCVR5104HS-S3	HCVR5108HS-S3	HCVR5116HS-S3
	Audio Bit Rate	64Kbps		
Video Port	Analog Video Input	4-ch BNC port (HDCVI HD video/general standard definition video self-adaptive)	8-ch BNC port(HDCVI HD video/general standard definition video self-adaptive)	16-ch BNC port(HDCVI HD video/general standard definition video self-adaptive)
	Network Video Input	<ul style="list-style-type: none"> ● Max add 2 IP channel connections ● Analog /digital channel switch. Max 6 IP channel connections ● Connection bandwidth:8Mbps-24Mbps 	<ul style="list-style-type: none"> ● Max add 4 IP channel connection ● Analog /digital channel switch. Max 12 IP channel connections ● Connection bandwidth:16Mbps-48Mbps 	<ul style="list-style-type: none"> ● Max add 8 IP channel connections ● Analog /digital channel switch. Max 24 IP channel connections ● Connection bandwidth:32Mbps-96Mbps
	Video Output	1-channel VGA output, 1-channel HDMI output (of the same video source), HDMI/ VGA video output at the same time.		
	Loop Output	N/A		
	Matrix Output	N/A		
Audio Port	Audio Input	1-channel RCA port.		
	Coaxial Audio Input	4-ch	8-ch-	16-ch
	Audio Output	1-channel RCA port.		
	Bidirectional Talk Input	Reuse the audio input/output port of the 1 st channel.		
Record	Record Mode	Schedule record/manual record/MD record/Alarm record		
	Playback Mode	Instant playback, normal playback, event playback, mark playback, smart playback		
	Record Playback	Max 4-channel playback	Max 8-channel playback	Max 16-channel playback
	Backup Mode	HDD, burner, USB device, network backup		
Alarm	Alarm Input	N/A		
	Alarm Output	N/A		
HDD	HDD Port	1 SATA port,does not support eSATA port		
	One HDD Space	6T		
Communication	Network	1 RJ45 port, 100Mbps Ethernet port		

	Parameters	HCVR5104HS-S3	HCVR5108HS-S3	HCVR5116HS-S3
Port	Communication	RS485 port		
	USB	2 USB2.0 ports(One at the front panel and one at the rear panel)		
Others	Power	DC12V		
	Power Consumption (No HDD)	≤7W	≤8W	≤10W
	Working Temperature	-10℃~+55℃		
	Working Humidity	10%~90%		
	Dimensions	Compact 1U case, 260mm (W) x220mm (D) x44mm (H)		
	Weight (No HDD)	≤0.85KG	≤0.95KG	≤1.05KG
	Installation Mode	Desk		

1.3.35 HCVR71XXHS-S3 Series

	Parameters	HCVR7104HS-S3
System	Main Processor	Industrial embedded micro controller
	OS	Embedded LINUX
Video Parameters	Video Encode Standard	H.264
	Encode Resolution	1080P/720P/960H/D1/HD1/2CIF/CIF
	Video Frame Rate	PAL:1~25f/s; NTSC:1~30f/s
	Video Bit Rate	32Kbps-6144Kbps, For 720P: default setup is 2Mbps,max supports 4Mbps. For 1080P: default setup is 4Mbps,max supports 6Mbps.
	Bit Stream Type	Video stream/composite stream
	Dual-Stream	Support
Audio Parameters	Encode Standard	G.711A/G.711U/PCM
	Audio Sampling Rate	8KHz,16Bit
	Audio Bit Rate	64Kbps
Video Port	Analog Video Input	4-ch BNC port(HDCVI HD video/general standard definition video self-adaptive)
	Network Video Input	<ul style="list-style-type: none"> ● Max add 2 IP channel connections ● Analog/digital channel switch. Max 6 IP channel connections ● Connection bandwidth:8Mbps-24Mbps
	Video Output	1-channel VGA output,

	Parameters	HCVR7104HS-S3
		1-channel HDMI output (of the same video source), HDMI/ VGA video output at the same time.
	Loop Output	N/A
	Matrix Output	N/A
Audio Port	Audio Input	1-channel RCA port.
	Coaxial Audio Input	4-ch
	Audio Output	1-channel RCA port.
	Bidirectional Talk Input	Reuse the audio input/output port of the 1 st channel.
Record	Record Mode	Schedule record/manual record/MD record/Alarm record
	Playback Mode	Instant playback, normal playback, event playback, mark playback, smart playback
	Backup Mode	HDD, burner, USB device, network backup
Alarm	Alarm Input	N/A
	Alarm Output	N/A
HDD	HDD Port	1 SATA port, does not support eSATA port
	One HDD Space	6T
Communication Port	Network	1 RJ45 port, 100Mbps Ethernet port
	Communication	RS485 port
	USB	2 USB2.0 ports(One at the front panel and one at the rear panel)
Others	Power	DC12V
	Power Consumption (No HDD)	≤8W
	Working Temperature	-10℃~+55℃
	Working Humidity	10%~90%
	Dimensions	Compact 1U case, 260mm (W) ×220mm (D) ×44mm (H)
	Weight (No HDD)	0.85KG
	Installation Mode	Desk

1.3.36 HCVR52XXA-V2 Series

Model	Parameters	HCVR5204A-V2	HCVR5208A-V2	HCVR5216A-V2
System	Main Processor	High-performance industrial embedded micro controller		
	OS	Embedded LINUX		
Video	Video Encode Standard	H.264		

Model	Parameters	HCVR5204A-V2	HCVR5208A-V2	HCVR5216A-V2
	Encode Resolution	720P/960H/D1/HD1/2CIF/CIF/QCIF (for sub-stream only)		
	Video Frame Rate	PAL:1~25f/s; NTSC:1~30f/s		
	Video Bit Rate	1536Kbps-4096Kbps, For 720P:default value is 2Mbps,max value is 4Mbps		
	Bit Stream Type	Video stream/composite stream		
	Dual-Stream	Support		
Audio	Encode Standard	G.711A, G.711U, PCM		
	Audio Sampling Rate	8KHz,16Bit		
	Audio Bit Rate	64Kbps		
Video Port	Analog Video Input	4-ch, BNC port	8-ch, BNC port	16-ch, BNC port
	Network Video Input	Switch 2 analog channels to the IP channels (8Mbps)		
	Video Output	1-ch VGA output, 1-ch HDMI output, HDMI/ VGA video output at the same time (VGA/HDMI of the same video source)		
	Loop Output	N/A		
	Matrix Output	N/A		
Audio Port	Audio Input	4-ch,RCA port, audio via coaxial cable		
	Audio Output	1-ch,RCA port		
	Bidirectional Talk Input	Support (Reuse the audio port)		
Record	Record Mode	Auto record, manual record, motion detect record, alarm record		
	Record Playback	Max 4-ch playback	Max 8-ch playback	Max 16-ch playback
	Backup Mode	HDD, burner, flash disk, network backup.		
Alarm	Alarm Input	4-ch alarm input	8-ch alarm input	16-ch alarm input
	Alarm Output	3-ch alarm output		
HDD	HDD Port	2 SATA ports. Does not support eSATA port		
	Space/HDD	4T		
Communication Port	Network	1 RJ45 port, 1000Mbps Ethernet port		
	Communication	RS485 port		
	USB	2 USB ports		
Other	Power	DC12V		
	Power Consumption	≤30W (exclude HDD)		
	Working Temperature	-10℃~+55℃		
	Working Humidity	10%~90%		
	Dimension	1U case,375mm (W) x280mm (D) x50mm (H)		
	Weight	1.5kg~2.5kg (exclude HDD)		
	Installation Mode	Desk installation		

1.3.37 HCVR72XXA-V2 Series

Model	Parameters	HCVR7204A-V2	HCVR7208A-V2
System	Main Processor	High-performance industrial embedded micro controller	
	OS	Embedded LINUX	
Video	Video Encode Standard	H.264	
	Encode Resolution	1080P /720P/960H/D1/HD1/2CIF/CIF/QCIF (for sub-stream only)	
	Video Frame Rate	PAL:1~25f/s; NTSC:1~30f/s	
	Video Bit Rate	2048Kbps-6144Kbps Kbps-4096Kbps, For 1080P:default value is 4Mbps,max value is 6Mbps	
	Bit Stream Type	Video stream/composite stream	
	Dual-Stream	Support	
Audio	Encode Standard	G.711A, G.711U, PCM	
	Audio Sampling Rate	8KHz,16Bit	
	Audio Bit Rate	64Kbps	
Video Port	Analog Video Input	4-ch, BNC port	8-ch, BNC port
	Network Video Input	Switch 2 analog channels to the IP channels (16Mbps)	
	Video Output	1-ch VGA output, 1-ch HDMI output, HDMI/ VGA video output at the same time (VGA/HDMI of the same video source)	
	Loop Output	N/A	
	Matrix Output	N/A	
Audio Port	Audio Input	4-ch,RCA port, audio via coaxial cable	
	Audio Output	1-ch,RCA port	
	Bidirectional Talk Input	Support (Reuse the audio port)	
Record	Record Mode	Auto record, manual record, motion detect record, alarm record	
	Record Playback	Max 4-ch playback	Max 16-ch playback
	Backup Mode	HDD, burner, flash disk, network backup.	
Alarm	Alarm Input	4-ch alarm input	16-ch alarm input
	Alarm Output	3-ch alarm output	
HDD	HDD Port	2 SATA ports. Does not support eSATA port.	
	Space/HDD	4T	
Communication Port	Network	1 RJ45 port, 1000Mbps Ethernet port	
	Communication	RS485 port	
	USB	2 USB ports	
Other	Power	DC12V	
	Power Consumption	≤30W (exclude HDD)	
	Working Temperature	-10℃~+55℃	

Model	Parameters	HCVR7204A-V2	HCVR7208A-V2
	Working Humidity	10%~90%	
	Dimension	1U case,375mm (W) x280mm (D) x50mm (H)	
	Weight	1.5kg~2.5kg (exclude HDD)	
	Installation Mode	Desk installation	

1.3.38 HCVR42XXA-S2/4216AN-S2 Series

Model	Parameters	HCVR4204A-S2	HCVR4208A-S2	HCVR4216A-S2	HCVR4216AN-S2
System	Main Processor	High-performance industrial embedded micro controller			
	OS	Embedded LINUX			
Video	Video Encode Standard	H.264			
	Encode Resolution	720P(1-15fps)/960H/D1/HD1/2CIF/CIF/QCIF (for sub-stream only)			
	Video Frame Rate	HDCVI:1~15f/s (The 1 st channel supports 25/30f/s) CVBS:1~25f/s (PAL) ; 1~30f/s (NTSC)			
	Video Bit Rate	1024Kbps-4096Kbps, For 720P:default value is 1Mbps,max value is 4Mbps For 960H:default value is 1Mbps,max value is 3Mbps			
	Bit Stream Type	Video stream/composite stream			
	Dual-Stream	Support			
Audio	Encode Standard	G.711A, G.711U, PCM			
	Audio Sampling Rate	8KHz,16Bit			
	Audio Bit Rate	64Kbps			
Video Port	Analog Video Input	4-ch, BNC port	8-ch, BNC port	16-ch, BNC port	16-ch, BNC port
	Network Video Input	Max 2 IPC connections (8Mbps)			
	Video Output	1-ch VGA output, 1-ch HDMI output, HDMI/ VGA video output at the same time (VGA/HDMI of the same video source)			
	Loop Output	N/A			
	Matrix Output	N/A			
Audio Port	Audio Input	4-ch,RCA port,			1-ch,RC A port
	Audio Output	1-ch,RCA port			
	Bidirectional Talk Input	Support (Reuse the audio port)			

Model	Parameters	HCVR4204A-S2	HCVR4208A-S2	HCVR4216A-S2	HCVR4216AN-S2
Record	Record Mode	Auto record, manual record, motion detect record, alarm record			
	Record Playback	Max 4-ch playback	Max 8-ch playback	Max 16-ch playback	
	Backup Mode	HDD, burner, flash disk, network backup.			
Alarm	Alarm Input	8-ch alarm input	8-ch alarm input	16-ch alarm input	N/A
	Alarm Output	3-ch alarm output			N/A
HDD	HDD Port	2 SATA ports. Does not support eSATA port.			
	Space/HDD	4T			
Communication Port	Network	1 RJ45 port, 100Mbps Ethernet port			
	Communication	RS485 port			
	USB	2 USB ports			
Other	Power	DC12V/4A			
	Power Consumption	≤30W (No HDD)			
	Working Temperature	-10°C ~ +55°C			
	Working Humidity	10%~90%			
	Dimension	1U case, 375mm (W) × 280mm (D) × 50mm (H)			
	Weight	1.5-2.5kg (no HDD)			
	Installation Mode	Desk installation			

1.3.39 HCVR4224/4232AN-S2 Series

Model	Parameters	HCVR4224AN-S2	HCVR4232AN-S2
System	Main Processor	High-performance industrial embedded micro controller	
	OS	Embedded LINUX	
Video	Video Encode Standard	H.264	
	Encode Resolution	720P(1-15fps)/960H/D1/HD1/2CIF/CIF/QCIF (for sub-stream only)	
	Video Frame Rate	HDCVI:1~15f/s (The 1 st /2 nd channel supports 25/30f/s) CVBS:1~25f/s (PAL) ; 1~30f/s (NTSC)	
	Video Bit Rate	1024Kbps~4096Kbps, For 720P realtime (The first two channels):default value is 2Mbps,max value is 4Mbps. For 720P non-realtime: default value is 1Mbps,max value is 2Mbps.	
	Bit Stream Type	Video stream/composite stream	
	Dual-Stream	Support	

Model	Parameters	HCVR4224AN-S2	HCVR4232AN-S2
Audio	Encode Standard	G.711A, G.711U, PCM	
	Audio Sampling Rate	8KHz,16Bit	
	Audio Bit Rate	64Kbps	
Video Port	Analog Video Input	24-ch, BNC port	32-ch, BNC port
	Network Video Input	Max 4 IPC connections (16Mbps)	
	Video Output	1-ch VGA output, 1-ch HDMI output, HDMI/ VGA video output at the same time (VGA/HDMI of the same video source)	
	Loop Output	N/A	
	Matrix Output	N/A	
Audio Port	Audio Input	1-ch,RCA port, Coaxibale audio	1-ch,RCA port. Coaxibale audio
	Audio Output	1-ch,RCA port	
	Bidirectional Talk Input	Support (Reuse the audio port)	
Record	Record Mode	Auto record, manual record, motion detect record, alarm record	
	Record Playback	Max 16-ch playback	
	Backup Mode	HDD, burner, flash disk, network backup.	
Alarm	Alarm Input	N/A	
	Alarm Output	N/A	
HDD	HDD Port	2 SATA ports. Does not support eSATA port.	
	Space/HDD	4T	
Communication Port	Network	1 RJ45 port, 1000Mbps Ethernet port	
	Communication	1 RS485 port	
	USB	2 USB ports	
Other	Power	DC12V/5A	
	Power Consumption	≤30W (With adapter, no HDD)	
	Working Temperature	-10℃~+55℃	
	Working Humidity	10%~90%	
	Dimension	1U case,375mm (W) x280mm (D) x50mm (H)	
	Weight	1.5-2.5kg (no HDD)	

Model	Parameters	HCVR4224AN-S2	HCVR4232AN-S2
	Installation Mode	Desk installation	

1.3.40 HCVR52XXA-S2/HCVR5216AN-S2 Series

Model	Parameters	HCVR5204A-S2	HCVR5208A-S2	HCVR5216A-S2	HCVR5216AN-S2
System	Main Processor	High-performance industrial embedded micro controller			
	OS	Embedded LINUX			
Video	Video Encode Standard	H.264			
	Encode Resolution	1080P(1-15fps) /720P/960H/D1/HD1/2CIF/CIF/QCIF			
	Video Frame Rate	HDCVI:1~25f/s (PAL) ; 1~30f/s (NTSC) CVBS:1~25f/s (PAL) ; 1~30f/s (NTSC)			
	Video Bit Rate	2048Kbps-4096Kbps For 1080P/720P:default value is 2Mbps,max value is 4Mbps For 960H:default value is 1Mbps,max value is 3Mbps			
	Bit Stream Type	Video stream/composite stream			
	Dual-Stream	Support			
Audio	Encode Standard	G.711A, G.711U, PCM			
	Audio Sampling Rate	8KHz,16Bit			
	Audio Bit Rate	64Kbps			
Video Port	Analog Video Input	4-ch, BNC port	8-ch, BNC port	16-ch, BNC port	16-ch, BNC port
	Network Video Input	Max 2 IPC connections (8Mbps)			
	Video Output	1-ch VGA output, 1-ch HDMI output, HDMI/ VGA video output at the same time (VGA/HDMI of the same video source)			
	Loop Output	N/A			
	Matrix Output	N/A			
Audio Port	Audio Input	4-ch,RCA port, audio via coaxial cable			
	Audio Output	1-ch,RCA port			
	Bidirectional Talk Input	Support (Reuse the audio port)			
Record	Record Mode	Auto record, manual record, motion detect record, alarm record			

Model	Parameters	HCVR5204A-S2	HCVR5208A-S2	HCVR5216A-S2	HCVR5216AN-S2	
	Record Playback	Max 4-ch playback	Max 8-ch playback	Max 16-ch playback		
	Backup Mode	HDD, burner, flash disk, network backup.				
Alarm	Alarm Input	8-ch alarm input	8-ch alarm input	16-ch alarm input	N/A	
	Alarm Output	3-ch alarm output				N/A
HDD	HDD Port	2 SATA ports. Does not support eSATA port.				
	Space/HDD	4T				
Communication Port	Network	1 RJ45 port, 100Mbps Ethernet port				
	Communication	RS485 port				
	USB	2 USB ports				
Other	Power	DC12V/4A				DC12V/5A
	Power Consumption	≤30W (No HDD)				
	Working Temperature	-10℃~+55℃				
	Working Humidity	10%~90%				
	Dimension	1U case,375mm (W) x280mm (D) x50mm (H)				
	Weight	1.5-2.5kg (No HDD)				
	Installation Mode	Desk installation				

1.3.41 HCVR720XA-S2 Series

Model	Parameters	HCVR7204A-S2	HCVR7208A-S2
System	Main Processor	High-performance industrial embedded micro controller	
	OS	Embedded LINUX	
Video	Video Encode Standard	H.264	
	Encode Resolution	1080P /720P/960H/D1/HD1/2CIF/CIF/QCIF	
	Video Frame Rate	HDCVI:1~25f/s (PAL) ; 1~30f/s (NTSC) CVBS:1~25f/s (PAL) ; 1~30f/s (NTSC)	
	Video Bit Rate	2048Kbps-6144Kbps For 1080P:default value is 4Mbps,max value is 6Mbps For 720P:default value is 2Mbps,max value is 4Mbps	
	Bit Stream Type	Video stream/composite stream	
	Dual-Stream	Support	

Model	Parameters	HCVR7204A-S2	HCVR7208A-S2
Audio	Encode Standard	G.711A, G.711U, PCM	
	Audio Sampling Rate	8KHz,16Bit	
	Audio Bit Rate	64Kbps	
Video Port	Analog Video Input	4-ch, BNC port	8-ch, BNC port
	Network Video Input	Max 2 IPC connections 16Mbps)	
	Video Output	1-ch VGA output, 1-ch HDMI output, HDMI/ VGA video output at the same time (VGA/HDMI of the same video source)	
	Loop Output	N/A	
	Matrix Output	N/A	
Audio Port	Audio Input	4-ch,RCA port, audio via coaxial cable	
	Audio Output	1-ch,RCA port	
	Bidirectional Talk Input	Support (Reuse the audio port)	
Record	Record Mode	Auto record, manual record, motion detect record, alarm record	
	Record Playback	Max 4-ch playback	Max 8-ch playback
	Backup Mode	HDD, burner, flash disk, network backup.	
Alarm	Alarm Input	8-ch alarm input	16-ch alarm input
	Alarm Output	3-ch alarm output	
HDD	HDD Port	2 SATA ports. Does not support eSATA port.	
	Space/HDD	4T	
Communication Port	Network	1 RJ45 port, 100Mbps Ethernet port	
	Communication	RS485 port	
	USB	2 USB ports	
Other	Power	DC12V/4A	DC12V/5A
	Power Consumption	≤30W (No HDD)	
	Working Temperature	-10℃~+55℃	
	Working Humidity	10%~90%	
	Dimension	1U case,375mm (W) x280mm (D) x50mm (H)	
	Weight	1.5-2.5kg (No HDD)	
	Installation Mode	Desk installation	

1.3.42 HCVR42XXA-S3 Series

Model	Parameters	HCVR4204A-S3	HCVR4208A-S3	HCVR4216A-S3
System	Main Processor	High-performance industrial embedded micro controller		
	OS	Embedded LINUX		
Video	Video Encode Standard	H.264		
	Encode Resolution	1080N/720P/ 960H/D1/HD1/ 2CIF/CIF/	1080N@12f/720P@15f/960H/D1/HD1/2 CIF/CIF	
	Video Frame Rate	PAL:1~25f/s; NTSC:1~30f/s		
	Video Bit Rate	32Kbps~4096Kbps, For 720P:default value is 1.5Mbps,max value is 4Mbps. For 1080P:default value is 1.5Mbps,max value is 4Mbps.		
	Bit Stream Type	Video stream/composite stream		
	Dual-Stream	Support		
Audio	Encode Standard	G.711A, G.711U, PCM		
	Audio Sampling Rate	8KHz,16Bit		
	Audio Bit Rate	64Kbps		
Video Port	Analog Video Input	4-ch BNC port (HDCVI HD video/general standard definition video self-adaptive)	8-ch BNC port(HDCVI HD video/general standard definition video self-adaptive)	16-ch BNC port(HDCVI HD video/general standard definition video self-adaptive)

Model	Parameters	HCVR4204A-S3	HCVR4208A-S3	HCVR4216A-S3
	Network Video Input	<ul style="list-style-type: none"> ● Max add 1 IP channel connection ● Analog /digital channel switch. Max 5 IP channel connections ● Connection bandwidth:4Mbps-20Mbps 	<ul style="list-style-type: none"> ● Max add 2 IP channel connections ● Analog /digital channel switch. Max 10 IP channel connections ● Connection bandwidth:8Mbps-40Mbps 	<ul style="list-style-type: none"> ● Max add 2 IP channel connections ● Analog /digital channel switch. Max 18 IP channel connections ● Connection bandwidth :8Mbps-56 Mbps
	Video Output	1-ch VGA output, 1-ch HDMI output, HDMI/ VGA video output at the same time (VGA/HDMI of the same video source)		
	Loop Output	N/A		
	Matrix Output	N/A		
Audio Port	External Audio Input	4-ch,RCA port,		
	Coaxial Audio Input	4-ch	8-ch	16-ch
	Audio Output	1-ch RCA port		
	Bidirectional Talk Input	Support (Reuse the audio port of the 1 st channel)		
Record	Record Mode	Auto record, manual record, motion detect record, alarm record		
	Playback Mode	Instant playback, normal playback, event playback, mark playback, smart playback		
	Record Playback	Max 4-ch playback	Max 8-ch playback	Max 16-ch playback
	Backup Mode	HDD, burner, flash disk, network backup.		
Alarm	Alarm Input	8-ch alarm input	8-ch alarm input	16-ch alarm input
	Alarm Output	3-ch alarm output		
HDD	HDD Port	2 SATA ports. Does not support eSATA port.		
	Space/HDD	4T	6T	
Communication	Network	1 RJ45 port, 100Mbps Ethernet port		

Model	Parameters	HCVR4204A-S3	HCVR4208A-S3	HCVR4216A-S3
Port	Communication	RS485 port		
	USB	2 USB2.0 ports(One at the front panel and one at the rear panel)		
Other	Power	DC12V		
	Power Consumption (No HDD)	≤7W	≤8W	≤10W
	Working Temperature	-10℃~+55℃		
	Working Humidity	10%~90%		
	Dimension	1U case,375mm (W) x280mm (D) x50mm (H)		
	Weight (No HDD)	≤1.5KG	≤1.65KG	≤1.8KG
	Installation Mode	Desk installation		

1.3.43 HCVR42XXAN-S3 Series

Model	Parameters	HCVR4216AN-S3	HCVR4232AN-S3
System	Main Processor	High-performance industrial embedded micro controller	
	OS	Embedded LINUX	
Video	Video Encode Standard	H.264	
	Encode Resolution	1080N@12f/720P@15f/960H/D1/HD1/2CIF/CIF	
	Video Frame Rate	PAL:1~25f/s; NTSC:1~30f/s	
	Video Bit Rate	32Kbps~4096Kbps, For 720P:default value is 1.5Mbps,max value is 4Mbps. For 1080P:default value is 1.5Mbps,max value is 4Mbps.	
	Bit Stream Type	Video stream/composite stream	
	Dual-Stream	Support	
Audio	Encode Standard	G.711A, G.711U, PCM	
	Audio Sampling Rate	8KHz,16Bit	
	Audio Bit Rate	64Kbps	
Video Port	Analog Video Input	16-ch BNC port(HDCVI HD video/general standard definition video self-adaptive)	32-ch BNC port(HDCVI HD video/general standard definition video self-adaptive)

Model	Parameters	HCVR4216AN-S3	HCVR4232AN-S3
	Network Video Input	<ul style="list-style-type: none"> ● Max add 2 IP channel connections ● Analog /digital channel switch. Max 18 IP channel connections ● Connection bandwidth:8Mbps-56Mbps 	<ul style="list-style-type: none"> ● Analog /digital channel switch. Max 16 IP channel connections ● Connection bandwidth: Max 64Mbps
	Video Output	1-ch VGA output, 1-ch HDMI output, HDMI/ VGA video output at the same time (VGA/HDMI of the same video source)	
	Loop Output	N/A	
	Matrix Output	N/A	
Audio Port	External Audio Input	1-ch,RCA port	
	Coaxial Audio Input	16-ch	32-ch
	Audio Output	1-ch RCA port	
	Bidirectional Talk Input	Support (Reuse the audio port of the 1 st channel)	
Record	Record Mode	Auto record, manual record, motion detect record, alarm record	
	Playback Mode	Instant playback, normal playback, event playback, mark playback, smart playback	
	Record Playback	Max 16-ch playback	
	Backup Mode	HDD, burner, flash disk, network backup.	
Alarm	Alarm Input	N/A	
	Alarm Output	N/A	
HDD	HDD Port	2 SATA ports. Does not support eSATA port.	
	Space/HDD	6T	8T
Communication Port	Network	1 RJ45 port, 100Mbps Ethernet port	
	Communication	RS485 port	
	USB	2 USB2.0 ports(One at the front panel and one at the rear panel)	
Other	Power	DC12V	
	Power Consumption (No HDD)	≤10	≤20W
	Working Temperature	-10℃~+55℃	

Model	Parameters	HCVR4216AN-S3	HCVR4232AN-S3
	Working Humidity	10%~90%	
	Dimension	1U case,375mm (W) x280mm (D) x50mm (H)	
	Weight (No HDD)	≤1.8KG	≤3.3KG
	Installation Mode	Desk installation	

1.3.44 HCVR52XXA-S3 Series

Model	Parameters	HCVR5204A-S3	HCVR5208A-S3	HCVR5216A-S3
System	Main Processor	High-performance industrial embedded micro controller		
	OS	Embedded LINUX		
Video	Video Encode Standard	H.264		
	Encode Resolution	1080P@15f/1080N/720P/960H/D1/HD1/2CIF/CIF		
	Video Frame Rate	PAL:1~25f/s; NTSC:1~30f/s		
	Video Bit Rate	32Kbps~6144Kbps, For 720P:default value is 2Mbps,max value is 4Mbps For 1080P:default value is 2Mbps,max value is 6Mbps		
	Bit Stream Type	Video stream/composite stream		
	Dual-Stream	Support		
Audio	Encode Standard	G.711A, G.711U, PCM		
	Audio Sampling Rate	8KHz,16Bit		
	Audio Bit Rate	64Kbps		
Video Port	Analog Video Input	4-ch BNC port (HDCVI HD video/general standard definition video self-adaptive)	8-ch BNC port(HDCVI HD video/general standard definition video self-adaptive)	16-ch BNC port(HDCVI HD video/general standard definition video self-adaptive)

Model	Parameters	HCVR5204A-S3	HCVR5208A-S3	HCVR5216A-S3
	Network Video Input	<ul style="list-style-type: none"> ● Max add 2 IP channel connections ● Analog /digital channel switch. Max 6 IP channel connections ● Connection bandwidth:8Mbps-24Mbps 	<ul style="list-style-type: none"> ● Max add 4 IP channel connections ● Analog /digital channel switch. Max 12 IP channel connections ● Connection bandwidth:16Mbps-48Mbps 	<ul style="list-style-type: none"> ● Max add 8 IP channel connections ● Analog /digital channel switch. Max 24 IP channel connections ● Connection bandwidth:32Mbps-96Mbps
	Video Output	1-ch VGA output, 1-ch HDMI output, HDMI/ VGA video output at the same time (VGA/HDMI of the same video source)		
	Loop Output	N/A		
	Matrix Output	N/A		
Audio Port	External Audio Input	4-ch,RCA port,		
	Coaxial Audio Input	4-ch	8-ch-	16-ch
	Audio Output	1-ch RCA port		
	Bidirectional Talk Input	Support (Reuse the audio port of the 1 st channel)		
Record	Record Mode	Auto record, manual record, motion detect record, alarm record		
	Playback Mode	Instant playback, normal playback, event playback, mark playback, smart playback		
	Record Playback	Max 4-ch playback	Max 8-ch playback	Max 16-ch playback
	Backup Mode	HDD, burner, flash disk, network backup.		
Alarm	Alarm Input	8-ch alarm input	8-ch alarm input	16-ch alarm input
	Alarm Output	3-ch alarm output		
HDD	HDD Port	2 SATA ports. Does not support eSATA port.		
	Space/HDD	4T	6T	
Communication Port	Network	1 RJ45 port, 100Mbps Ethernet port		
	Communication	RS485 port		
	USB	2 USB2.0 ports(One at the front panel and one at the rear panel)		
Other	Power	DC12V		
	Power Consumption (No HDD)	≤7W	≤8W	≤10W

Model	Parameters	HCVR5204A-S3	HCVR5208A-S3	HCVR5216A-S3
	Working Temperature	-10℃~+55℃		
	Working Humidity	10%~90%		
	Dimension	1U case,375mm (W) x280mm (D) x50mm (H)		
	Weight (no HDD)	≤1.5KG	≤1.65KG	≤1.8KG
	Installation Mode	Desk installation		

1.3.45 HCVR52XXAN-S3 Series

Model	Parameters	HCVR5216AN-S3	HCVR5232AN-S3
System	Main Processor	High-performance industrial embedded micro controller	
	OS	Embedded LINUX	
Video	Video Encode Standard	H.264	
	Encode Resolution	1080P@15f/1080N/720P/960H/D1/HD1/2CIF/CIF	
	Video Frame Rate	PAL:1~25f/s; NTSC:1~30f/s	
	Video Bit Rate	32Kbps~6144Kbps, For 720P:default value is 2Mbps,max value is 4Mbps For 1080P:default value is 2Mbps,max value is 6Mbps	
	Bit Stream Type	Video stream/composite stream	
	Dual-Stream	Support	
Audio	Encode Standard	G.711A, G.711U, PCM	
	Audio Sampling Rate	8KHz,16Bit	
	Audio Bit Rate	64Kbps	
Video Port	Analog Video Input	16-ch BNC port(HDCVI HD video/general standard definition video self-adaptive)	32-ch BNC port(HDCVI HD video/general standard definition video self-adaptive)
	Network Video Input	<ul style="list-style-type: none"> ● Max add 8 IP channel connections ● Analog /digital channel switch. Max 24 IP channel connections ● Connection bandwidth:32Mbps-96Mbps 	<ul style="list-style-type: none"> ● Analog /digital channel switch. Max 32 IP channel connections ● Connection bandwidth: Max 128Mbps

Model	Parameters	HCVR5216AN-S3	HCVR5232AN-S3
	Video Output	1-ch VGA output, 1-ch HDMI output, HDMI/ VGA video output at the same time (VGA/HDMI of the same video source)	
	Loop Output	N/A	
	Matrix Output	N/A	
Audio Port	External Audio Input	1-ch,RCA port	
	Coaxial Audio Input	16-ch	32-ch
	Audio Output	1-ch RCA port	
	Bidirectional Talk Input	Support (Reuse the audio port of the 1 st channel)	
Record	Record Mode	Auto record, manual record, motion detect record, alarm record	
	Playback Mode	Instant playback, normal playback, event playback, mark playback, smart playback	
	Record Playback	Max 16-ch playback	
	Backup Mode	HDD, burner, flash disk, network backup.	
Alarm	Alarm Input	N/A	
	Alarm Output	N/A	
HDD	HDD Port	2 SATA ports. Does not support eSATA port.	
	Space/HDD	6T	8T
Communication Port	Network	1 RJ45 port, 1000Mbps Ethernet port	
	Communication	RS485 port	
	USB	2 USB2.0 ports(One at the front panel and one at the rear panel)	
Other	Power	DC12V	
	Power Consumption (No HDD)	≤10W	≤25W
	Working Temperature	-10℃~+55℃	
	Working Humidity	10%~90%	
	Dimension	1U case,375mm (W) x280mm (D) x50mm (H)	
	Weight (no HDD)	≤1.8KG	
	Installation Mode	Desk installation	

1.3.46 HCVR72XXA-S3/HCVR7216AN-S3 Series

Model	Parameters	HCVR7204A-S3	HCVR7208A-S3	HCVR7216A-S3	HCVR7216AN-S3
System	Main Processor	High-performance industrial embedded micro controller			
	OS	Embedded LINUX			
Video	Video Encode Standard	H.264			
	Encode Resolution	1080P@15f/1080N/720P/960H/D1/HD1/2CIF/CIF			
	Video Frame Rate	PAL:1~25f/s; NTSC:1~30f/s			
	Video Bit Rate	32Kbps~6144Kbps, For 720P:default value is 2Mbps,max value is 4Mbps For 1080P:default value is 2Mbps,max value is 6Mbps			
	Bit Stream Type	Video stream/composite stream			
	Dual-Stream	Support			
	Audio	Encode Standard	G.711A, G.711U, PCM		
Audio Sampling Rate		8KHz,16Bit			
Audio Bit Rate		64Kbps			
Video Port	Analog Video Input	4-ch BNC port (HDCVI HD video/general standard definition video self-adaptive)	8-ch BNC port(HDCVI HD video/general standard definition video self-adaptive)	16-ch BNC port(HDCVI HD video/general standard definition video self-adaptive)	16-ch BNC port(HDCVI HD video/general standard definition video self-adaptive)

Model	Parameters	HCVR7204A-S3	HCVR7208A-S3	HCVR7216A-S3	HCVR7216AN-S3	
	Network Video Input	<ul style="list-style-type: none"> ● Max add 2 IP channel connections ● Analog /digital channel switch. Max 6 IP channel connections ● Connection bandwidth:8 Mbps-24Mbps 	<ul style="list-style-type: none"> ● Max add 4 IP channel connections ● Analog /digital channel switch. Max 12 IP channel connections ● Connection bandwidth: 16Mbps-48 Mbps 	<ul style="list-style-type: none"> ● Max add 8 IP channel connections ● Analog /digital channel switch. Max 24 IP channel connections ● Connection bandwidth:32Mbps-96Mbps 	<ul style="list-style-type: none"> ● Max add 8 IP channel connections ● Analog /digital channel switch. Max 24 IP channel connections ● Connection bandwidth: 32Mbps-96 Mbps 	
	Video Output	1-ch VGA output, 1-ch HDMI output, HDMI/ VGA video output at the same time (VGA/HDMI of the same video source)				
	Loop Output	N/A				
	Matrix Output	N/A				
Audio Port	External Audio Input	4-ch,RCA port,				1-ch,RCA port
	Coaxial Audio Input	4-ch	8-ch-	16-ch	16-ch	
	Audio Output	1-ch RCA port				
	Bidirectional Talk Input	Support (Reuse the audio port of the 1 st channel)				
Record	Record Mode	Auto record, manual record, motion detect record, alarm record				
	Playback Mode	Instant playback, normal playback, event playback, mark playback, smart playback				
	Record Playback	Max 4-ch playback	Max 8-ch playback	Max 16-ch playback		
	Backup Mode	HDD, burner, flash disk, network backup.				
Alarm	Alarm Input	8-ch alarm input	8-ch alarm input	16-ch alarm input	N/A	
	Alarm Output	3-ch alarm output				N/A
HDD	HDD Port	2 SATA ports. Does not support eSATA port.				
	Space/HDD	4T	6T			
Communication	Network	1 RJ45 port, 100Mbps Ethernet port				

Model	Parameters	HCVR7204A-S3	HCVR7208A-S3	HCVR7216A-S3	HCVR7216AN-S3
Port	Communication	RS485 port			
	USB	2 USB2.0 ports(One at the front panel and one at the rear panel)			
Other	Power	DC12V			
	Power Consumption (No HDD)	≤8W	≤10W	≤15W	≤15W
	Working Temperature	-10℃~+55℃			
	Working Humidity	10%~90%			
	Dimension	1U case,375mm (W) x280mm (D) x50mm (H)			
	Weight (no HDD)	≤1.5KG	≤1.65KG	≤1.8KG	≤1.8KG
	Installation Mode	Desk installation			

1.3.47 HCVR52XXL-V2 Series

Model	Parameters	HCVR5204L-V2	HCVR5208L-V2	HCVR5216L-V2
System	Main Processor	High-performance industrial embedded micro controller		
	OS	Embedded LINUX		
Video	Video Encode Standard	H.264		
	Encode Resolution	720P/960H/D1/HD1/2CIF/CIF/QCIF (for sub-stream only)		
	Video Frame Rate	PAL:1~25f/s; NTSC:1~30f/s		
	Video Bit Rate	1536Kbps-4096Kbps, For 720P:default value is 2Mbps,max value is 4Mbps		
	Bit Stream Type	Video stream/composite stream		
	Dual-Stream	Support		
Audio	Encode Standard	G.711A, G.711U, PCM		
	Audio Sampling Rate	8KHz,16Bit		
	Audio Bit Rate	64Kbps		
Video Port	Analog Video Input	4-ch, BNC port	8-ch, BNC port	16-ch, BNC port
	Network Video Input	Switch 2 analog channels to the IP channels (8Mbps)		

Model	Parameters	HCVR5204L-V2	HCVR5208L-V2	HCVR5216L-V2
	Video Output	1-ch VGA output, 1-ch HDMI output, HDMI/ VGA video output at the same time (VGA/HDMI of the same video source)		
	Loop Output	N/A		
	Matrix Output	N/A		
Audio Port	Audio Input	4-ch,RCA port, audio via coaxial cable		
	Audio Output	1-ch,RCA port		
	Bidirectional Talk Input	Support (Reuse the audio port)		
Record	Record Mode	Auto record, manual record, motion detect record, alarm record		
	Record Playback	Max 4-ch playback	Max 8-ch playback	Max 16-ch playback
	Backup Mode	HDD, burner, flash disk, network backup.		
Alarm	Alarm Input	4-ch alarm input	8-ch alarm input	16-ch alarm input
	Alarm Output	3-ch alarm output		
HDD	HDD Port	2 SATA ports. Does not support eSATA port		
	Space/HDD	4T		
Communication Port	Network	1 RJ45 port, 1000Mbps Ethernet port		
	Communication	RS485 port		
	USB	2 USB ports		
Other	Power	DC12V		
	Power Consumption	≤30W (exclude HDD)		
	Working Temperature	-10℃~+55℃		
	Working Humidity	10%~90%		
	Dimension	1.5U case,440mm (W) ×410mm (D) ×70mm (H)		
	Weight	3.0kg~3.5kg (exclude HDD)		
	Installation Mode	Desk installation		

1.3.48 HCVR54XXL-V2 Series

Model	Parameters	HCVR5404L-V2	HCVR5408L-V2	HCVR5416L-V2
System	Main Processor	High-performance industrial embedded micro controller		
	OS	Embedded LINUX		
Video	Video Encode Standard	H.264		
	Encode Resolution	720P/960H/D1/HD1/2CIF/CIF/QCIF (for sub-stream only)		

Model	Parameters	HCVR5404L-V2	HCVR5408L-V2	HCVR5416L-V2
	Video Frame Rate	PAL:1~25f/s; NTSC:1~30f/s		
	Video Bit Rate	1536Kbps-4096Kbps, For 720P:default value is 2Mbps,max value is 4Mbps		
	Bit Stream Type	Video stream/composite stream		
	Dual-Stream	Support		
Audio	Encode Standard	G.711A, G.711U, PCM		
	Audio Sampling Rate	8KHz,16Bit		
	Audio Bit Rate	64Kbps		
Video Port	Analog Video Input	4-ch, BNC port	8-ch, BNC port	16-ch, BNC port
	Network Video Input	Switch 2 analog channels to the IP channels (8Mbps)		
	Video Output	1-ch VGA output, 1-ch HDMI output, 1-ch TV output, HDMI/ VGA/TV video output at the same time (VGA/HDMI/TV of the same video source)		
	Loop Output	N/A		
	Matrix Output	N/A		
Audio Port	Audio Input	4-ch,BNC port, audio via coaxial cable		
	Audio Output	1-ch,BNC port		
	Bidirectional Talk Input	Support (Independent bidirectional talk port)		
Record	Record Mode	Auto record, manual record, motion detect record, alarm record		
	Record Playback	Max 4-ch playback	Max 8-ch playback	Max 16-ch playback
	Backup Mode	HDD, burner, flash disk, network backup.		
Alarm	Alarm Input	8-ch alarm input	8-ch alarm input	16-ch alarm input
	Alarm Output	6-ch alarm output		
HDD	HDD Port	4 SATA ports. Does not support eSATA port		
	Space/HDD	4T		
Communication Port	Network	1 RJ45 port, 1000Mbps Ethernet port		
	Communication	1 RS232 port, 1 RS422 port, 1 RS485 port		
	USB	3 USB ports (One at the front panel and two at the rear panel)		
Other	Power	AC90~264V 50+2% Hz (4/8-ch max 75W)		
	Power Consumption	≤35W (exclude HDD)		

Model	Parameters	HCVR5404L-V2	HCVR5408L-V2	HCVR5416L-V2
	Working Temperature	-10℃~+55℃		
	Working Humidity	10%~90%		
	Dimension	1.5U case,440mm (W) x410mm (D) x70mm (H)		
	Weight	4.5kg~5.5kg (exclude HDD)		
	Installation Mode	Desk/rack installation		

1.3.49 HCVR4224/32L-S2 Series

Model	Parameters	HCVR4224L-S2	HCVR4232L-S2
System	Main Processor	High-performance industrial embedded micro controller	
	OS	Embedded LINUX	
Video	Video Encode Standard	H.264	
	Encode Resolution	720P(1-15fps)/960H/D1/HD1/2CIF/CIF/QCIF (for sub-stream only)	
	Video Frame Rate	HDCVI:1~15f/s (The 1 st / 2 nd channel supports 25/30f/s) CVBS:1~25f/s (PAL) ; 1~30f/s (NTSC)	
	Video Bit Rate	1024Kbps~4096Kbps, For 720P realtime (The first two channels):default value is 2Mbps,max value is 4Mbps. For 720P non-realtime: default value is 1Mbps,max value is 2Mbps.	
	Bit Stream Type	Video stream/composite stream	
	Dual-Stream	Support	
Audio	Encode Standard	G.711A, G.711U, PCM	
	Audio Sampling Rate	8KHz,16Bit	
	Audio Bit Rate	64Kbps	
Video Port	Analog Video Input	24-ch, BNC port	32-ch, BNC port
	Network Video Input	Max 4 IPC connections (16Mbps)	
	Video Output	1-ch VGA output, 1-ch HDMI output, HDMI/ VGA video output at the same time (VGA/HDMI of the same video source)	
	Loop Output	N/A	
	Matrix Output	N/A	
Audio Port	Audio Input	4-ch,RCA port, Coaxible audio	4-ch,RCA port. Coaxible audio

Model	Parameters	HCVR4224L-S2	HCVR4232L-S2
	Audio Output	1-ch,RCA port	
	Bidirectional Talk Input	Support (Reuse the audio port)	
Record	Record Mode	Auto record, manual record, motion detect record, alarm record	
	Record Playback	Max 16-ch playback	
	Backup Mode	HDD, burner, flash disk, network backup.	
Alarm	Alarm Input	16-channel alarm input	
	Alarm Output	3-channel alarm output	
HDD	HDD Port	2 SATA ports. Does not support eSATA port.	
	Space/HDD	4T	
Communication Port	Network	1 RJ45 port, 1000Mbps Ethernet port	
	Communication	1 RS232 port, 1 RS485 port	
	USB	2 USB ports	
Other	Power	DC12V/5A	
	Power Consumption	≤30W (With adapter, no HDD)	
	Working Temperature	-10°C ~ +55°C	
	Working Humidity	10%~90%	
	Dimension	1.5U case,440mm (W) x410mm (D) x70mm (H)	
	Weight	4.5-5.5kg (no HDD)	
	Installation Mode	Desk/rack installation	

1.3.50 HCVR44XXL-S2 Series

Model	Parameters	HCVR4404L-S2	HCVR4408L-S2	HCVR4416L-S2
System	Main Processor	High-performance industrial embedded micro controller		
	OS	Embedded LINUX		
Video	Video Encode Standard	H.264		
	Encode Resolution	720P/960H/D1/HD1/2CIF/CIF/QCIF (for sub-stream only)		
	Video Frame Rate	HDCVI:1~15f/s (The 1st channel supports 25/30f/s) CVBS:1~25f/s (PAL) ; 1~30f/s (NTSC)		
	Video Bit Rate	1536Kbps-4096Kbps, For 720P:default value is 2Mbps,max value is 4Mbps		
	Bit Stream Type	Video stream/composite stream		
	Dual-Stream	Support		

Model	Parameters	HCVR4404L-S2	HCVR4408L-S2	HCVR4416L-S2
Audio	Encode Standard	G.711A, G.711U, PCM		
	Audio Sampling Rate	8KHz,16Bit		
	Audio Bit Rate	64Kbps		
Video Port	Analog Video Input	4-ch, BNC port	8-ch, BNC port	16-ch, BNC port
	Network Video Input	Switch 2 analog channels to the IP channels (8Mbps)		
	Video Output	1-ch VGA output, 1-ch HDMI output, 1-ch TV output, HDMI/ VGA/TV video output at the same time (VGA/HDMI/TV of the same video source)		
	Loop Output	N/A		
	Matrix Output	N/A		
Audio Port	Audio Input	4-ch,BNC port, audio via coaxial cable		
	Audio Output	1-ch,BNC port		
	Bidirectional Talk Input	Support (Independent bidirectional talk port)		
Record	Record Mode	Auto record, manual record, motion detect record, alarm record		
	Record Playback	Max 4-ch playback	Max 8-ch playback	Max 16-ch playback
	Backup Mode	HDD, burner, flash disk, network backup.		
Alarm	Alarm Input	8-ch alarm input	8-ch alarm input	16-ch alarm input
	Alarm Output	6-ch alarm output		
HDD	HDD Port	4 SATA ports. Does not support eSATA port		
	Space/HDD	6T		
Communication Port	Network	1 RJ45 port, 1000Mbps Ethernet port		
	Communication	1 RS232 port, 1 RS422 port, 1 RS485 port		
	USB	3 USB ports (One at the front panel and two at the rear panel)		
Other	Power	AC90~264V 50+2% Hz (4/8-ch max 75W)		
	Power Consumption	≤35W (exclude HDD)		
	Working Temperature	-10℃~+55℃		
	Working Humidity	10%~90%		
	Dimension	1.5U case,440mm (W) x410mm (D) x70mm (H)		
	Weight	4.5kg~5.5kg (exclude HDD)		

Model	Parameters	HCVR4404L-S2	HCVR4408L-S2	HCVR4416L-S2
	Installation Mode	Desk/rack installation		

Model	Parameters	HCVR4424L-S2	HCVR4432L-S2
System	Main Processor	High-performance industrial embedded micro controller	
	OS	Embedded LINUX	
Video	Video Encode Standard	H.264	
	Encode Resolution	720P/960H/D1/HD1/2CIF/CIF/QCIF (for sub-stream only)	
	Video Frame Rate	HDCVI:1~15f/s (The 1 st /2 nd channel supports 25/30f/s) CVBS:1~25f/s (PAL) ; 1~30f/s (NTSC)	
	Video Bit Rate	1024Kbps-4096Kbps, For 720P realtime (The first two channels):default value is 2Mbps,max value is 4Mbps. For 720P non-realtime: default value is 1Mbps,max value is 2Mbps.	
	Bit Stream Type	Video stream/composite stream	
	Dual-Stream	Support	
Audio	Encode Standard	G.711A, G.711U, PCM	
	Audio Sampling Rate	8KHz,16Bit	
	Audio Bit Rate	64Kbps	
Video Port	Analog Video Input	24-ch, BNC port	32-ch, BNC port
	Network Video Input	Switch 4 analog channels to the IP channels (16Mbps)	
	Video Output	1-ch VGA output, 1-ch HDMI output, 1-ch TV output, HDMI/ VGA/TV video output at the same time (VGA/HDMI/TV of the same video source)	
	Loop Output	N/A	
	Matrix Output	N/A	
Audio Port	Audio Input	4-ch,BNC port, audio via coaxial cable	
	Audio Output	1-ch,BNC port	
	Bidirectional Talk Input	Support (Independent bidirectional talk port)	
Record	Record Mode	Auto record, manual record, motion detect record, alarm record	
	Record Playback	Max 16-ch playback	
	Backup Mode	HDD, burner, flash disk, network backup.	

Model	Parameters	HCVR4424L-S2	HCVR4432L-S2
Alarm	Alarm Input	16-ch alarm input	
	Alarm Output	6-ch alarm output	
HDD	HDD Port	4 SATA ports. Does not support eSATA port	
	Space/HDD	6T	
Communication Port	Network	1 RJ45 port, 1000Mbps Ethernet port	
	Communication	1 RS232 port, 1 RS422 port	
	USB	3 USB ports (One at the front panel and two at the rear panel)	
Other	Power	AC110~240V 50+2%HZ (max 220W)	
	Power Consumption	≤35W (exclude HDD)	
	Working Temperature	-10°C ~ +55°C	
	Working Humidity	10%~90%	
	Dimension	1.5U case,440mm (W) x410mm (D) x70mm (H)	
	Weight	4.5kg~5.5kg (exclude HDD)	
	Installation Mode	Desk/rack installation	

1.3.51 HCVR48XXS-S2 Series

Model	Parameters	HCVR4804S-S2	HCVR4808S-S2	HCVR4816S-S2
System	Main Processor	High-performance industrial embedded micro controller		
	OS	Embedded LINUX		
Video	Video Encode Standard	H.264		
	Encode Resolution	720P/960H/D1/HD1/2CIF/CIF/QCIF (for sub-stream only)		
	Video Frame Rate	HDCVI:1~15f/s (The 1st channel supports 25/30f/s) CVBS:1~25f/s (PAL) ; 1~30f/s (NTSC)		
	Video Bit Rate	1536Kbps-4096Kbps, For 720P:default value is 2Mbps,max value is 4Mbps		
	Bit Stream Type	Video stream/composite stream		
	Dual-Stream	Support		
Audio	Encode Standard	G.711A, G.711U, PCM		
	Audio Sampling Rate	8KHz,16Bit		
	Audio Bit Rate	64Kbps		
Video Port	Analog Video Input	4-ch, BNC port	8-ch, BNC port	16-ch, BNC port

Model	Parameters	HCVR4804S-S2	HCVR4808S-S2	HCVR4816S-S2
	Network Video Input	Switch 2 analog channels to the IP channels (8Mbps)		
	Video Output	1-ch VGA output, 1-ch HDMI output, 1-ch TV output, HDMI/ VGA/TV video output at the same time (VGA/HDMI/TV of the same video source)		
	Loop Output	N/A		
	Matrix Output	N/A		
Audio Port	Audio Input	4-ch,BNC port, audio via coaxial cable	8-ch,BNC port, audio via coaxial cable	16-ch,BNC port, audio via coaxial cable
	Audio Output	1-ch,BNC port		
	Bidirectional Talk Input	Support (Independent bidirectional talk port)		
Record	Record Mode	Auto record, manual record, motion detect record, alarm record		
	Record Playback	Max 4-ch playback	Max 8-ch playback	Max 16-ch playback
	Backup Mode	HDD, burner, flash disk, network backup.		
Alarm	Alarm Input	8-ch alarm input	8-ch alarm input	16-ch alarm input
	Alarm Output	6-ch alarm output		
HDD	HDD Port	8 SATA ports,does not support eSATA port		
	Space/HDD	6T		
Communication Port	Network	1 RJ45 port, 1000Mbps Ethernet port		2 RJ45 ports, 1000Mbps Ethernet ports
	Communication	1 RS232 port, 1 RS422 port, 1 RS485 port		
	USB	4 USB ports (Two at the front panel and two at the rear panel)		
Other	Power	AC90~264V 50+2% Hz (Max 220W)		
	Power Consumption	≤35W (exclude HDD)		
	Working Temperature	-10℃~+55℃		
	Working Humidity	10%~90%		
	Dimension	2U case,440mm (W) x460mm (D) x89mm (H)		
	Weight	7.0kg~8.0kg (exclude HDD)		
	Installation Mode	Desk/rack installation		

Model	Parameters	HCVR4824S-S2	HCVR4832S-S2
System	Main Processor	High-performance industrial embedded micro controller	
	OS	Embedded LINUX	
Video	Video Encode Standard	H.264	
	Encode Resolution	720P/960H/D1/HD1/2CIF/CIF/QCIF (for sub-stream only)	
	Video Frame Rate	HDCVI:1~15f/s (The 1 st / 2 nd channel supports 25/30f/s) CVBS:1~25f/s (PAL) ; 1~30f/s (NTSC)	
	Video Bit Rate	1024Kbps-4096Kbps, For 720P realtime (The first two channels):default value is 2Mbps,max value is 4Mbps. For 720P non-realtime: default value is 1Mbps,max value is 2Mbps.	
	Bit Stream Type	Video stream/composite stream	
	Dual-Stream	Support	
Audio	Encode Standard	G.711A, G.711U, PCM	
	Audio Sampling Rate	8KHz,16Bit	
	Audio Bit Rate	64Kbps	
Video Port	Analog Video Input	24-ch, BNC port	32-ch, BNC port
	Network Video Input	Switch 4 analog channels to the IP channels (16Mbps)	
	Video Output	1-ch VGA output, 1-ch HDMI output, 1-ch TV output, HDMI/ VGA/TV video output at the same time (VGA/HDMI/TV of the same video source)	
	Loop Output	N/A	
	Matrix Output	N/A	
Audio Port	Audio Input	16-ch,BNC port, audio via coaxial cable	16-ch,BNC port, audio via coaxial cable
	Audio Output	1-ch,BNC port	
	Bidirectional Talk Input	Support (Independent bidirectional talk port)	
Record	Record Mode	Auto record, manual record, motion detect record, alarm record	
	Record Playback	Max 16-ch playback	
	Backup Mode	HDD, burner, flash disk, network backup.	
Alarm	Alarm Input	16-ch alarm input	
	Alarm Output	6-ch alarm output	
HDD	HDD Port	8 SATA ports	

Model	Parameters	HCVR4824S-S2	HCVR4832S-S2
	Space/HDD	6T	
Communication Port	Network	2 RJ45 ports, 1000Mbps Ethernet ports	
	Communication	1 RS232 port, 1 RS422 port	
	USB	4 USB ports (Two at the front panel and two at the rear panel)	
Other	Power	AC110~240V 50+2%HZ (Max 220W)	
	Power Consumption	≤35W (exclude HDD)	
	Working Temperature	-10℃~+55℃	
	Working Humidity	10%~90%	
	Dimension	2U case,440mm (W) x460mm (D) x89mm (H)	
	Weight	7.0kg~8.0kg (exclude HDD)	
	Installation Mode	Desk/rack installation	

1.3.52 HCVR58XXS-V2 Series

Model	Parameters	HCVR5804S-V2	HCVR5808S-V2	HCVR5816S-V2
System	Main Processor	High-performance industrial embedded micro controller		
	OS	Embedded LINUX		
Video	Video Encode Standard	H.264		
	Encode Resolution	720P/960H/D1/HD1/2CIF/CIF/QCIF (for sub-stream only)		
	Video Frame Rate	PAL:1~25f/s; NTSC:1~30f/s		
	Video Bit Rate	1536Kbps-4096Kbps, For 720P:default value is 2Mbps,max value is 4Mbps		
	Bit Stream Type	Video stream/composite stream		
	Dual-Stream	Support		
Audio	Encode Standard	G.711A, G.711U, PCM		
	Audio Sampling Rate	8KHz,16Bit		
	Audio Bit Rate	64Kbps		
Video Port	Analog Video Input	4-ch, BNC port	8-ch, BNC port	16-ch, BNC port
	Network Video Input	Switch 2 analog channels to the IP channels (8Mbps)		

Model	Parameters	HCVR5804S-V2	HCVR5808S-V2	HCVR5816S-V2
	Video Output	1-ch VGA output, 1-ch HDMI output, 1-ch TV output, HDMI/ VGA/TV video output at the same time (VGA/HDMI/TV of the same video source)		
	Loop Output	N/A		
	Matrix Output	N/A		
Audio Port	Audio Input	4-ch,BNC port, audio via coaxial cable	8-ch,BNC port, audio via coaxial cable	16-ch,BNC port, audio via coaxial cable
	Audio Output	1-ch,RCA port		
	Bidirectional Talk Input	Support (Independent bidirectional talk port)		
Record	Record Mode	Auto record, manual record, motion detect record, alarm record		
	Record Playback	Max 4-ch playback	Max 8-ch playback	Max 16-ch playback
	Backup Mode	HDD, burner, flash disk, network backup.		
Alarm	Alarm Input	8-ch alarm input	8-ch alarm input	16-ch alarm input
	Alarm Output	6-ch alarm output		
HDD	HDD Port	8 SATA ports,does not support eSATA port		
	Space/HDD	4T		
Communication Port	Network	2 RJ45 ports, 1000Mbps Ethernet port		
	Communication	1 RS232 port, 1 RS422 port, 1 RS485 port		
	USB	3 USB ports (One at the front panel and two at the rear panel)		
Other	Power	AC90~264V 50+2% Hz (Max 220W)		
	Power Consumption	≤35W (exclude HDD)		
	Working Temperature	-10℃~+55℃		
	Working Humidity	10%~90%		
	Dimension	2U case,440mm (W) x460mm (D) x89mm (H)		
	Weight	7.0kg~8.0kg (exclude HDD)		
	Installation Mode	Desk/rack installation		

1.3.53 HCVR71XXH-4M Series

Model	Parameters	HCVR7104H-4M	HCVR7108H-4M	HCVR7116H-4M
System	Main Processor	Industrial embedded micro controller		
	OS	Embedded LINUX		
Video Parameters	Video Encode Standard	H.264+/H.264		

Model	Parameters	HCVR7104H-4M	HCVR7108H-4M	HCVR7116H-4M
	Encode Resolution	Main stream: 2K(2560*1440)@15f/1080P/720P/960H/D1/HD1/BCIF/CIF/QCIF Sub stream: D1/CIF/QCIF		
	Video Frame Rate	2K resolution: PAL:1~15f/s; NTSC:1~15f/s Other resolutions: PAL:1~25f/s; NTSC:1~30f/s		
	Video Bit Rate	32Kbps-6144Kbps, For 720P: default setup is 2Mbps,max supports 4Mbps. For 1080N: default setup is 4Mbps,max supports 6Mbps. For 2K: non realtime default setup is 4Mbps,max supports 6Mbps.		
	Bit Stream Type	Video stream/composite stream		
	Dual-Stream	Support		
Audio Parameters	Encode Standard	G.711A/G.711U/PCM		
	Audio Sampling Rate	8KHz,16Bit		
	Audio Bit Rate	64Kbps		
Video Port	Analog Video Input	4-ch BNC port (HDCVI/CVBS)	8-ch BNC port (HDCVI/CVBS)	16-ch BNC port (HDCVI/CVBS)
	Network Video Input	<ul style="list-style-type: none"> ● Max add 2 IP channel connection. ● Analog /digital channel switch. Max 6 IP channel connections ● Connection bandwidth:8Mbps-24Mbps 	<ul style="list-style-type: none"> ● Max add 4 IP channel connection. ● Analog /digital channel switch. Max 12 IP channel connections ● Connection bandwidth:16Mbps-48Mbps 	<ul style="list-style-type: none"> ● Max add 8 IP channel connection. ● Analog /digital channel switch. Max 24 IP channel connections ● Connection bandwidth:32Mbps-96Mbps
	Video Output	1-channel VGA output, 1-channel HDMI output, max 4K(3840*2160)@30f HDMI/ VGA video output at the same time (of the same video source or different video source).		
	Loop Output	N/A		
	Matrix Output	When the HDMI and VGA are of different video output, system supports one matrix output.		
Audio Port	Audio Input	1-channel RCA port.		
	Coaxial Audio Input	N/A		
	Audio Output	1-channel RCA port.		
	Bidirectional Talk Input	Reuse the audio input/output port		
Record	Record Mode	Schedule record/manual record/MD record/Alarm record/intelligent		

Model	Parameters	HCVR7104H-4M	HCVR7108H-4M	HCVR7116H-4M
		record		
	Playback Mode	Instant playback, normal playback, event playback, mark playback, smart playback		
	Playback Channel	4-channel	8-channel	16-channel
	Backup Mode	HDD, burner, USB device, network backup		
Alarm	Alarm Input	N/A		
	Alarm Output	N/A		
HDD	HDD Port	1 SATA port		
	One HDD Space	8T		
Communication Port	Network	1 RJ45 port, 1000Mbps Ethernet port		
	Communication	1 RS485 port		
	USB	2 USB ports(One USB2.0 port at the front panel and one USB3.0 port at the rear panel)		
Others	Power	DC12V		
	Power Consumption (No HDD)	≤12W	≤13W	≤20W
	Working Temperature	-10℃~+55℃		
	Working Humidity	10%~90%		
	Dimensions	Mini 1U case, 325mm (W) x245mm (D) x45mm (H)		
	Weight (No HDD)	≤1.25KG	≤1.25KG	≤1.40KG
	Installation Mode	Desk		

1.3.54 HCVR72XXAN-4M Series

Model	Parameters	HCVR7204AN-4M	HCVR7208AN-4M	HCVR7216AN-4M
System	Main Processor	Industrial embedded micro controller		
	OS	Embedded LINUX		
Video Parameters	Video Encode Standard	H.264+/H.264		
	Encode Resolution	Main 2K(2560*1440)/1080P/720P/960H/D1/HD1/BCIF/CIF/QCIF Sub stream: D1/CIF/QCIF		stream:
	Video Frame Rate	2K resolution: PAL:1~15f/s; NTSC:1~15f/s Other resolutions: PAL:1~25f/s; NTSC:1~30f/s		
	Video Bit Rate	32Kbps-6144Kbps, For 720P: default setup is 2Mbps,max supports 4Mbps. For 1080N: default setup is 4Mbps,max supports 6Mbps. For 2K: non realtime default setup is 4Mbps,max supports 6Mbps.		
	Bit Stream Type	Video stream/composite stream		
	Dual-Stream	Support		

Model	Parameters	HCVR7204AN-4M	HCVR7208AN-4M	HCVR7216AN-4M
Audio Parameters	Encode Standard	G.711A/G.711U/PCM		
	Audio Sampling Rate	8KHz,16Bit		
	Audio Bit Rate	64Kbps		
Video Port	Analog Video Input	4-ch BNC port (HDCVI/CVBS)	8-ch BNC port (HDCVI/CVBS)	16-ch BNC port (HDCVI/CVBS)
	Network Video Input	<ul style="list-style-type: none"> ● Max add 2 IP channel connection. ● Analog /digital channel switch. Max 6 IP channel connections ● Connection bandwidth:8Mbps-24Mbps 	<ul style="list-style-type: none"> ● Max add 4 IP channel connection. ● Analog /digital channel switch. Max 12 IP channel connections ● Connection bandwidth:16 Mbps-48Mbps 	<ul style="list-style-type: none"> ● Max add 8 IP channel connection. ● Analog /digital channel switch. Max 24 IP channel connections ● Connection bandwidth:32Mbps-96Mbps
	Video Output	1-channel VGA output, 1-channel HDMI output, max 4K(3840*2160)@30f HDMI/ VGA video output at the same time (of the same video source or different video source).		
	Loop Output	N/A		
	Matrix Output	When the HDMI and VGA are outputting different video, system supports one matrix output.		
	Audio Port	Audio Input	1-channel RCA port.	
Coaxial Audio Input		N/A		
Audio Output		1-channel RCA port.		
Bidirectional Talk Input		Reuse the audio input/output port		
Record	Record Mode	Schedule record/manual record/MD record/Alarm record/intelligent record		
	Playback Mode	Instant playback, normal playback, event playback, mark playback, smart playback		
	Playback Channel	4-channel	8-channel	16-channel
	Backup Mode	HDD, burner, USB device, network backup		
Alarm	Alarm Input	N/A		
	Alarm Output	N/A		
HDD	HDD Port	2 SATA ports		
	One HDD Space	8T		
Communication Port	Network	1 RJ45 port, 1000Mbps Ethernet port		
	Communication	1 RS485 port		

Model	Parameters	HCVR7204AN-4M	HCVR7208AN-4M	HCVR7216AN-4M
	USB	2 USB ports(One USB2.0 port at the front panel and one USB3.0 port at the rear panel)		
Others	Power	DC12V		
	Power Consumption (No HDD)	≤12W	≤13W	≤20W
	Working Temperature	-10℃~+55℃		
	Working Humidity	10%~90%		
	Dimensions	1U case, 375mm (W) x280mm (D) x50mm (H)		
	Weight (No HDD)	≤1.60KG	≤1.60KG	≤1.75KG
	Installation Mode	Desk		

1.3.55 XVR410XC Series

	Parameters	XVR4104C	XVR4108C
System	Main Processor	Industrial embedded micro controller	
	OS	Embedded LINUX	
Video Parameters	Video Encode Standard	H.264	
	Encode Resolution	1080N/720P/960H/D1/HD1/2CIF/CIF	1080N@12f/720P@15f /960H/D1/HD1/2CIF/CIF
	Video Frame Rate	PAL:1~25f/s; NTSC:1~30f/s	
	Video Bit Rate	32Kbps-4096Kbps	
	Bit Stream Type	Video stream/composite stream	
	Dual-Stream	Support	
Audio Parameters	Encode Standard	G.711A/G.711U/PCM	
	Audio Sampling Rate	8KHz,16Bit	
	Audio Bit Rate	64Kbps	
Video Port	Analog Video Input	4-ch BNC port(CVBS/CVI/AHD/ other analog HD video self-adaptive)	8-ch BNC port(CVBS/CVI/AHD/other analog HD video self-adaptive)
	Network Video Input	<ul style="list-style-type: none"> ● There is no IP channel by default. Max add 1 IP channel connection ● Analog/digital channel switch. Max 5 IP channel connections ● Connection bandwidth:0Mbps-20Mbps 	<ul style="list-style-type: none"> ● There is no IP channel by default.Max add 2 IP channel connections ● Analog/digital channel switch. Max 10 IP channel connections ● Connection bandwidth:0Mbps-40Mbps
	Video Output	1-channel VGA output,	

	Parameters	XVR4104C	XVR4108C
		1-channel HDMI output (of the same video source), HDMI/ VGA video output at the same time.	
	Loop Output	N/A	
	Matrix Output	N/A	
Audio Port	Audio Input	1-channel RCA port.	
	Coaxial Audio Input	N/A	
	Audio Output	1-channel RCA port.	
	Bidirectional Talk Input	Reuse the audio input/output port of the 1 st channel.	
Record	Record Mode	Schedule record/manual record/MD record/Alarm record	
	Playback Mode	Instant playback, normal playback, event playback, mark playback, smart playback	
	Backup Mode	HDD, burner, USB device, network backup	
Alarm	Alarm Input	N/A	
	Alarm Output	N/A	
HDD	HDD Port	1 SATA port, does not support eSATA port	
	One HDD Space	6T	
Communication Port	Network	1 RJ45 port, 100Mbps Ethernet port	
	Communication	RS485 port	
	USB	2 USB2.0 ports(at the rear panel)	
Others	Power	DC12V	
	Power Consumption (No HDD)	≤7W	≤8W
	Working Temperature	-10℃~+55℃	
	Working Humidity	10%~90%	
	Dimensions	SMART 1U case, 270mm (W) x205mm (D) x41mm (H)	
	Weight (No HDD)	≤0.5KG	≤0.55KG
	Installation Mode	Desk	

1.3.56 XVR510XC Series

	Parameters	XVR5104C	XVR5108C
System	Main Processor	Industrial embedded micro controller	
	OS	Embedded LINUX	
Video Parameters	Video Encode Standard	H.264	
	Encode Resolution	1080P@15f/1080N/720P/960H/D1/HD1/2CIF/CIF/	
	Video Frame Rate	PAL:1~25f/s; NTSC:1~30f/s	
	Video Bit Rate	32Kbps-6144Kbps	
	Bit Stream Type	Video stream/composite stream	
	Dual-Stream	Support	

	Parameters	XVR5104C	XVR5108C
Audio Parameters	Encode Standard	G.711A/G.711U/PCM	
	Audio Sampling Rate	8KHz,16Bit	
	Audio Bit Rate	64Kbps	
Video Port	Analog Video Input	4-ch BNC port(CVBS/CVI/AHD /other analog HD video self-adaptive)	8-ch BNC port(CVBS/CVI/AHD/other analog HD video self-adaptive)
	Network Video Input	<ul style="list-style-type: none"> ● There is no IP channel by default. Max add 2 IP channel connections ● Analog/digital channel switch. Max 6 IP channel connections ● Connection bandwidth:0Mbps-24Mbps 	<ul style="list-style-type: none"> ● There is no IP channel by default. Max add 4 IP channel connections ● Analog/digital channel switch. Max 12 IP channel connections ● Connection bandwidth:0Mbps-48Mbps
	Video Output	1-channel VGA output, 1-channel HDMI output (of the same video source), HDMI/ VGA video output at the same time.	
	Loop Output	N/A	
	Matrix Output	N/A	
Audio Port	Audio Input	1-channel RCA port.	
	Coaxial Audio Input	N/A	
	Audio Output	1-channel RCA port.	
	Bidirectional Talk Input	Reuse the audio input/output port of the 1st channel.	
Record	Record Mode	Schedule record/manual record/MD record/Alarm record	
	Playback Mode	Instant playback, normal playback, event playback, mark playback, smart playback	
	Backup Mode	HDD, burner, USB device, network backup	
Alarm	Alarm Input	N/A	
	Alarm Output	N/A	
HDD	HDD Port	1 SATA port,does not support eSATA port	
	One HDD Space	6T	
Communication Port	Network	1 RJ45 port, 100Mbps Ethernet port	
	Communication	RS485 port	
	USB	2 USB2.0 ports(at the rear panel)	
Others	Power	DC12V	
	Power Consumption (No HDD)	≤7W	≤8W
	Working	-10℃~+55℃	

	Parameters	XVR5104C	XVR5108C
	Temperature		
	Working Humidity	10%~90%	
	Dimensions	SMART 1U case, 270mm (W) x205mm (D) x41mm (H)	
	Weight (No HDD)	≤0.5KG	≤0.55KG
	Installation Mode	Desk	

1.3.57 XVR7104C Series

	Parameters	XVR7104C
System	Main Processor	Industrial embedded micro controller
	OS	Embedded LINUX
Video Parameters	Video Encode Standard	H.264
	Encode Resolution	1080P/720P/960H/D1/HD1/2CIF/CIF
	Video Frame Rate	PAL:1~25f/s; NTSC:1~30f/s
	Video Bit Rate	32Kbps-6144Kbps
	Bit Stream Type	Video stream/composite stream
	Dual-Stream	Support
Audio Parameters	Encode Standard	G.711A/G.711U/PCM
	Audio Sampling Rate	8KHz,16Bit
	Audio Bit Rate	64Kbps
Video Port	Analog Video Input	4-ch BNC port(CVBS/CVI/AHD/other analog HD video self-adaptive)
	Network Video Input	<ul style="list-style-type: none"> ● There is no IP channel by default. Max add 2 IP channel connections ● Analog/digital channel switch. Max 6 IP channel connections ● Connection bandwidth:0Mbps-24Mbps
	Video Output	1-channel VGA output, 1-channel HDMI output (of the same video source), HDMI/ VGA video output at the same time.
	Loop Output	N/A
	Matrix Output	N/A
Audio Port	Audio Input	1-channel RCA port.
	Coaxial Audio Input	N/A
	Audio Output	1-channel RCA port.
	Bidirectional Talk Input	Reuse the audio input/output port of the 1st channel.

	Parameters	XVR7104C
Record	Record Mode	Schedule record/manual record/MD record/Alarm record
	Playback Mode	Instant playback, normal playback, event playback, mark playback, smart playback
	Backup Mode	HDD, burner, USB device, network backup
Alarm	Alarm Input	N/A
	Alarm Output	N/A
HDD	HDD Port	1 SATA port, does not support eSATA port
	One HDD Space	6T
Communication Port	Network	1 RJ45 port, 100Mbps Ethernet port
	Communication	RS485 port
	USB	2 USB2.0 ports(at the rear panel)
Others	Power	DC12V
	Power Consumption (No HDD)	≤8W
	Working Temperature	-10℃~+55℃
	Working Humidity	10%~90%
	Dimensions	SMART 1U case, 270mm (W) x205mm (D) x41mm (H)
	Weight (No HDD)	≤0.5KG
	Installation Mode	Desk

1.3.58 XVR41XXHE Series

	Parameters	XVR4104HE	XVR4108HE	XVR4116HE
System	Main Processor	Industrial embedded micro controller		
	OS	Embedded LINUX		
Video Parameters	Video Encode Standard	H.264		
	Encode Resolution	1080N/720P/960H/D1/HD1/2CIF/CIF	1080N@12f/720P@15f/960H/D1/HD1/2CIF/CIF	
	Video Frame Rate	PAL:1~25f/s; NTSC:1~30f/s		
	Video Bit Rate	32Kbps-4096Kbps		
	Bit Stream Type	Video stream/composite stream		
	Dual-Stream	Support		
Audio Parameters	Encode Standard	G.711A/G.711U/PCM		
	Audio Sampling	8KHz,16Bit		

	Parameters	XVR4104HE	XVR4108HE	XVR4116HE
	Rate			
	Audio Bit Rate	64Kbps		
Video Port	Analog Video Input	4-ch BNC port (CVBS/CVI/AHD /other analog HD video self-adaptive)	8-ch BNC port(CVBS/CVI/AHD /other analog HD video self-adaptive)	16-ch BNC port(CVBS/CVI/AHD /other analog HD video self-adaptive)
	Network Video Input	<ul style="list-style-type: none"> There is no IP channel by default. Max add 1 IP channel connection. Analog /digital channel switch. Max 5 IP channel connections Connection bandwidth:0Mbps-20Mbps 	<ul style="list-style-type: none"> There is no IP channel by default. Max add 2 IP channel connections Analog /digital channel switch. Max 10 IP channel connections Connection bandwidth:0Mbps-40Mbps 	<ul style="list-style-type: none"> There is no IP channel by default. Max add 2 IP channel connections Analog /digital channel switch. Max 18 IP channel connections Connection bandwidth:0 Mbps-56Mbps
	Video Output	1-channel VGA output, 1-channel HDMI output (of the same video source), HDMI/ VGA video output at the same time.		
	Loop Output	N/A		
	Matrix Output	N/A		
Audio Port	Audio Input	4-channel RCA port.	8-channel RCA port.	16-channel RCA port.
	Coaxial Audio Input	N/A		
	Audio Output	1-channel RCA port.		
	Bidirectional Talk Input	Support (Reuse the audio port of the 1st channel)		
Record	Record Mode	Schedule record/manual record/MD record/Alarm record		
	Playback Mode	Instant playback, normal playback, event playback, mark playback, smart playback		
	Record Playback	Max 4-channel playback	Max 8-channel playback	Max 16-channel playback
	Backup Mode	HDD, burner, USB device, network backup		

	Parameters	XVR4104HE	XVR4108HE	XVR4116HE
Alarm	Alarm Input	8-channel input	8-channel input	16-channel input
	Alarm Output	3-channel output		
HDD	HDD Port	1 SATA port, does not support eSATA port		
	One HDD Space	6T		
Communication Port	Network	1 RJ45 port, 100Mbps Ethernet port		
	Communication	RS485 port		
	USB	2 USB2.0 ports(One at the front panel and one at the rear panel)		
Others	Power	DC12V		
	Power Consumption	≤7W	≤8W	≤10W
	Working Temperature	-10℃~+55℃		
	Working Humidity	10%~90%		
	Dimensions	Mini 1U case, 325mm (W) x245mm (D) x45mm (H)		
	Weight	≤1.1KG	≤1.25KG	≤1.45KG
	Installation Mode	Desk		

1.3.59 XVR51XXH Series

	Parameters	XVR5104H	XVR5108H	XVR5116H
System	Main Processor	Industrial embedded micro controller		
	OS	Embedded LINUX		
Video Parameters	Video Encode Standard	H.264		
	Encode Resolution	1080P@15fps/1080N/720P/960H/D1/HD1/2CIF/CIF		
	Video Frame Rate	PAL:1~25f/s; NTSC:1~30f/s		
	Video Bit Rate	32Kbps-6144Kbps		
	Bit Stream Type	Video stream/composite stream		
	Dual-Stream	Support		
Audio Parameters	Encode Standard	G.711A/G.711U/PCM		
	Audio Sampling Rate	8KHz, 16Bit		
	Audio Bit Rate	64Kbps		
Video Port	Analog Video Input	4-ch BNC port (CVBS/CVI/AHD /other analog HD video self-adaptive)	8-ch BNC port(CVBS/CVI/AHD /other analog HD video self-adaptive)	16-ch BNC port(CVBS/CVI/AHD /other analog HD video

	Parameters	XVR5104H	XVR5108H	XVR5116H
				self-adaptive)
	Network Video Input	<ul style="list-style-type: none"> There is no IP channel by default. Max add 2 IP channel connections Analog /digital channel switch. Max 6 IP channel connections Connection bandwidth:0Mbps-24Mbps 	<ul style="list-style-type: none"> There is no IP channel by default. Max add 4 IP channel connections Analog /digital channel switch. Max 12 IP channel connections Connection bandwidth:0Mbps-48Mbps 	<ul style="list-style-type: none"> There is no IP channel by default. Max add 8 IP channel connections Analog /digital channel switch. Max 24 IP channel connections Connection bandwidth:0 Mbps-96Mbps
	Video Output	1-channel VGA output, 1-channel HDMI output (of the same video source), HDMI/ VGA video output at the same time.		
	Loop Output	N/A		
	Matrix Output	N/A		VGA/HDMI optional
Audio Port	Audio Input	1-channel RCA port.		
	Coaxial Audio Input	N/A		
	Audio Output	1-channel RCA port.		
	Bidirectional Talk Input	Support (Reuse the audio port of the 1st channel)		
Record	Record Mode	Schedule record/manual record/MD record/Alarm record		
	Playback Mode	Instant playback, normal playback, event playback, mark playback, smart playback		
	Record Playback	Max 4-channel playback	Max 8-channel playback	Max 16-channel playback
	Backup Mode	HDD, burner, USB device, network backup		
Alarm	Alarm Input	N/A		
	Alarm Output	N/A		
HDD	HDD Port	1 SATA port,does not support eSATA port		
	One HDD Space	6T		
Communication Port	Network	1 RJ45 port, 100Mbps Ethernet port		1 RJ45 port, 1000Mbps Ethernet port

	Parameters	XVR5104H	XVR5108H	XVR5116H
	Communication	RS485 port		
	USB	2 USB2.0 ports(One at the front panel and one at the rear panel)		1 USB2.0 port and 1 USB3.0 port (One USB2.0 port at the front panel and one USB3.0 port at the rear panel)
Others	Power	DC12V		
	Power Consumption	≤7W	≤8W	≤10W
	Working Temperature	-10℃~+55℃		
	Working Humidity	10%~90%		
	Dimensions	Mini 1U case,325mm (W) x245mm (D) x45mm (H)		
	Weight	≤1.1KG	≤1.25KG	≤1.45KG
	Installation Mode	Desk		

1.3.60 XVR51XXHE Series

	Parameters	XVR5104HE	XVR5108HE	XVR5116HE
System	Main Processor	Industrial embedded micro controller		
	OS	Embedded LINUX		
Video Parameters	Video Encode Standard	H.264		
	Encode Resolution	1080P@15f/720P/960H/D1/HD1/2CIF/CIF		
	Video Frame Rate	PAL:1~25f/s; NTSC:1~30f/s		
	Video Bit Rate	32Kbps-6144Kbps		
	Bit Stream Type	Video stream/composite stream		
	Dual-Stream	Support		
Audio Parameters	Encode Standard	G.711A/G.711U/PCM		
	Audio Sampling Rate	8KHz,16Bit		
	Audio Bit Rate	64Kbps		
Video Port	Analog Video Input	4-ch BNC port (CVBS/CVI/AHD /other analog HD	8-ch BNC port(CVBS/CVI/AHD /other analog HD	16-ch BNC port(CVBS/CVI/AHD /other analog

	Parameters	XVR5104HE	XVR5108HE	XVR5116HE
		video self-adaptive)	video self-adaptive)	HD video self-adaptive)
	Network Video Input	<ul style="list-style-type: none"> There is no IP channel by default. Max add 2 IP channel connections Analog /digital channel switch. Max 6 IP channel connections Connection bandwidth:0Mbps-24Mbps 	<ul style="list-style-type: none"> There is no IP channel by default. Max add 4 IP channel connections Analog /digital channel switch. Max 12 IP channel connections Connection bandwidth:0Mbps-48Mbps 	<ul style="list-style-type: none"> There is no IP channel by default. Max add 8 IP channel connections Analog /digital channel switch. Max 24 IP channel connections Connection bandwidth:0 Mbps-96Mbps
	Video Output	1-channel VGA output, 1-channel HDMI output (of the same video source), HDMI/ VGA video output at the same time.		
	Loop Output	N/A		
	Matrix Output	N/A		VGA/HDMI optional
Audio Port	Audio Input	4-channel RCA port.	8-channel RCA port.	16-channel RCA port.
	Coaxial Audio Input	N/A		
	Audio Output	1-channel RCA port.		
	Bidirectional Talk Input	Support (Reuse the audio port of the 1st channel)		
Record	Record Mode	Schedule record/manual record/MD record/Alarm record		
	Playback Mode	Instant playback, normal playback, event playback, mark playback, smart playback		
	Record Playback	Max 4-channel playback	Max 8-channel playback	Max 16-channel playback
	Backup Mode	HDD, burner, USB device, network backup		
Alarm	Alarm Input	8-channel input	8-channel input	16-channel input
	Alarm Output	3-channel output		
HDD	HDD Port	1 SATA port,does not support eSATA port		
	One HDD Space	6T		

	Parameters	XVR5104HE	XVR5108HE	XVR5116HE
Communication Port	Network	1 RJ45 port, 100Mbps Ethernet port		1 RJ45 port, 1000Mbps Ethernet port
	Communication	RS485 port		
	USB	2 USB2.0 ports(One at the front panel and one at the rear panel)		1 USB2.0 port and 1 USB3.0 port (One USB2.0 port at the front panel and one USB3.0 port at the rear panel)
Others	Power	DC12V		
	Power Consumption	≤7W	≤8W	≤10W
	Working Temperature	-10℃~+55℃		
	Working Humidity	10%~90%		
	Dimensions	Mini 1U case,325mm (W) ×245mm (D) ×45mm (H)		
	Weight	≤1.1KG	≤1.25KG	≤1.45KG
	Installation Mode	Desk		

1.3.61 XVR71XXHE Series

	Parameters	XVR7104HE	XVR7108HE	XVR7116HE
System	Main Processor	Industrial embedded micro controller		
	OS	Embedded LINUX		
Video Parameters	Video Encode Standard	H.264		
	Encode Resolution	1080P/720P/960H/D1/HD1/2CIF/CIF		
	Video Frame Rate	PAL:1~25f/s; NTSC:1~30f/s		
	Video Bit Rate	32Kbps-6144Kbps		
	Bit Stream Type	Video stream/composite stream		
	Dual-Stream	Support		
Audio Parameters	Encode Standard	G.711A/G.711U/PCM		
	Audio Sampling Rate	8KHz,16Bit		
	Audio Bit Rate	64Kbps		

	Parameters	XVR7104HE	XVR7108HE	XVR7116HE
Video Port	Analog Video Input	4-ch BNC port (CVBS/CVI/AHD /other analog HD video self-adaptive)	8-ch BNC port(CVBS/CVI/AHD /other analog HD video self-adaptive)	16-ch BNC port(CVBS/CVI/AHD /other analog HD video self-adaptive)
	Network Video Input	<ul style="list-style-type: none"> There is no IP channel by default. Max add 2 IP channel connection Analog /digital channel switch. Max 6 IP channel connections Connection bandwidth:0Mbps-24Mbps 	<ul style="list-style-type: none"> There is no IP channel by default. Max add 4 IP channel connections Analog /digital channel switch. Max 12 IP channel connections Connection bandwidth:0Mbps-48Mbps 	<ul style="list-style-type: none"> There is no IP channel by default. Max add 8 IP channel connections Analog /digital channel switch. Max 24 IP channel connections Connection bandwidth:0 Mbps-96Mbps
	Video Output	1-channel VGA output, 1-channel HDMI output (of the same video source), HDMI/ VGA video output at the same time.		
	Loop Output	N/A		
	Matrix Output	N/A	VGA/HDMI optional	
Audio Port	Audio Input	4-channel RCA port.	8-channel RCA port.	16-channel RCA port.
	Coaxial Audio Input	N/A		
	Audio Output	1-channel RCA port.		
	Bidirectional Talk Input	Support (Reuse the audio port of the 1st channel)		
Record	Record Mode	Schedule record/manual record/MD record/Alarm record		
	Playback Mode	Instant playback, normal playback, event playback, mark playback, smart playback		
	Record Playback	Max 4-channel playback	Max 8-channel playback	Max 16-channel playback
	Backup Mode	HDD, burner, USB device, network backup		
Alarm	Alarm Input	8-channel input	8-channel input	16-channel input
	Alarm Output	3-channel output		
HDD	HDD Port	1 SATA port,does not support eSATA port		

	Parameters	XVR7104HE	XVR7108HE	XVR7116HE
	One HDD Space	6T		
Communication Port	Network	1 RJ45 port, 100Mbps Ethernet port	1 RJ45 port, 1000Mbps Ethernet port	
	Communication	RS485 port		
	USB	2 USB2.0 ports(One at the front panel and one at the rear panel)	1 USB2.0 port and 1 USB3.0 port (One USB2.0 port at the front panel and one USB3.0 port at the rear panel)	
Others	Power	DC12V		
	Power Consumption	≤8W	≤10W	≤15W
	Working Temperature	-10℃~+55℃		
	Working Humidity	10%~90%		
	Dimensions	Mini 1U case,325mm (W) x245mm (D) x45mm (H)		
	Weight	≤1.1KG	≤1.25KG	≤1.45KG
	Installation Mode	Desk		

1.3.62 XVR71XXH Series

	Parameters	XVR7104H	XVR7108H	XVR7116H
System	Main Processor	Industrial embedded micro controller		
	OS	Embedded LINUX		
Video Parameters	Video Encode Standard	H.264		
	Encode Resolution	1080P/720P/960H/D1/HD1/2CIF/CIF		
	Video Frame Rate	PAL:1~25f/s; NTSC:1~30f/s		
	Video Bit Rate	32Kbps-6144Kbps		
	Bit Stream Type	Video stream/composite stream		
	Dual-Stream	Support		
Audio Parameters	Encode Standard	G.711A/G.711U/PCM		
	Audio Sampling Rate	8KHz,16Bit		
	Audio Bit Rate	64Kbps		
Video Port	Analog Video Input	4-ch BNC port (CVBS/CVI/AHD /other analog HD video self-adaptive)	8-ch BNC port(CVBS/CVI/AHD /other analog HD video self-adaptive)	16-ch BNC port(CVBS/CVI/AHD /other analog HD video

	Parameters	XVR7104H	XVR7108H	XVR7116H
				self-adaptive)
	Network Video Input	<ul style="list-style-type: none"> There is no IP channel by default. Max add 2 IP channel connections Analog /digital channel switch. Max 6 IP channel connections Connection bandwidth:0Mbps-24Mbps 	<ul style="list-style-type: none"> There is no IP channel by default. Max add 4 IP channel connections Analog /digital channel switch. Max 12IP channel connections Connection bandwidth:0Mbps-48Mbps 	<ul style="list-style-type: none"> There is no IP channel by default. Max add 8 IP channel connections Analog /digital channel switch. Max 24 IP channel connections Connection bandwidth:0 Mbps-96Mbps
	Video Output	1-channel VGA output, 1-channel HDMI output (of the same video source), HDMI/ VGA video output at the same time.		
	Loop Output	N/A		
	Matrix Output	N/A	VGA/HDMI optional	
Audio Port	Audio Input	1-channel RCA port.		
	Coaxial Audio Input	N/A		
	Audio Output	1-channel RCA port.		
	Bidirectional Talk Input	Support (Reuse the audio port of the 1st channel)		
Record	Record Mode	Schedule record/manual record/MD record/Alarm record		
	Playback Mode	Instant playback, normal playback, event playback, mark playback, smart playback		
	Record Playback	Max 4-channel playback	Max 8-channel playback	Max 16-channel playback
	Backup Mode	HDD, burner, USB device, network backup		
Alarm	Alarm Input	N/A		
	Alarm Output	N/A		
HDD	HDD Port	1 SATA port,does not support eSATA port		
	One HDD Space	6T		
Communication Port	Network	1 RJ45 port, 100Mbps Ethernet port	1 RJ45 port, 1000Mbps Ethernet port	
	Communication	RS485 port		

	Parameters	XVR7104H	XVR7108H	XVR7116H
	USB	2 USB2.0 ports(One at the front panel and one at the rear panel)	1 USB2.0 port and 1 USB3.0 port (One USB2.0 port at the front panel and one USB3.0 port at the rear panel)	
Others	Power	DC12V		
	Power Consumption	≤8W	≤10W	≤15W
	Working Temperature	-10℃~+55℃		
	Working Humidity	10%~90%		
	Dimensions	Mini 1U case,325mm (W) ×245mm (D) ×45mm (H)		
	Weight	≤1.1KG	≤1.25KG	≤1.45KG
	Installation Mode	Desk		

1.3.63 XVR21XXHS Series

	Parameters	XVR2104HS	XVR2108HS	XVR2116HS
System	Main Processor	Industrial embedded micro controller		
	OS	Embedded LINUX		
Video Parameters	Video Encode Standard	H.264		
	Encode Resolution	1080N@12f/720P@12f/960H/D1/HD1/2CIF/CIF		
	Video Frame Rate	PAL:1~25f/s; NTSC:1~30f/s		
	Video Bit Rate	32Kbps-4096Kbps		
	Bit Stream Type	Video stream		
	Dual-Stream	Support		
Audio Parameters	Encode Standard	N/A		
	Audio Sampling Rate	N/A		
	Audio Bit Rate	N/A		
Video Port	Analog Video Input	4-ch BNC port(CVBS/CVI/AHD /other analog HD video self-adaptive)	8-ch BNC port(CVBS/CVI/AHD /other analog HD video self-adaptive)	16-ch BNC port(CVBS/CVI/AHD /other analog HD video self-adaptive)
	Network Video Input	<ul style="list-style-type: none"> There is no IP channel by default. Max add 0 IP channel 	<ul style="list-style-type: none"> There is no IP channel by default. Max add 0 IP channel 	<ul style="list-style-type: none"> There is no IP channel by default. Max add 0 IP channel

	Parameters	XVR2104HS	XVR2108HS	XVR2116HS
		<ul style="list-style-type: none"> ● connection ● Analog /digital channel switch. Max 2 IP channel connections ● Connection bandwidth:0Mbps-8Mbps 	<ul style="list-style-type: none"> ● connection ● Analog /digital channel switch. Max 2 IP channel connections ● Connection bandwidth:0Mbps-8Mbps 	<ul style="list-style-type: none"> ● connection ● Analog /digital channel switch. Max 2 IP channel connections ● Connection bandwidth:0Mbps-8Mbps
	Video Output	1-channel VGA output, 1-channel HDMI output (of the same video source), HDMI/ VGA video output at the same time.		
	Loop Output	N/A		
	Matrix Output	N/A		
Audio Port	Audio Input	N/A		
	Coaxial Audio Input	N/A		
	Audio Output	N/A		
	Bidirectional Talk Input	N/A		
Record	Record Mode	Schedule record/manual record/MD record/Alarm record		
	Playback Mode	Instant playback, normal playback, event playback, mark playback, smart playback		
	Backup Mode	HDD, burner, USB device, network backup		
Alarm	Alarm Input	N/A		
	Alarm Output	N/A		
HDD	HDD Port	1 SATA port,does not support eSATA port		
	One HDD Space	6T		
Communication Port	Network	1 RJ45 port, 100Mbps Ethernet port		
	Communication	RS485 port		
	USB	2 USB2.0 ports(One at the front panel and one at the rear panel)		
Others	Power	DC12V		
	Power Consumption (No HDD)	≤10W		
	Working Temperature	-10℃~+55℃		
	Working Humidity	10%~90%		
	Dimensions	Compact 1U case, 260mm (W) ×220mm (D) ×44mm (H)		
	Weight (No	≤1.25KG	≤1.35KG	≤1.45KG

	Parameters	XVR2104HS	XVR2108HS	XVR2116HS
	HDD)			
	Installation Mode	Desk		

1.3.64 XVR41XXHS Series

	Parameters	XVR4104HS	XVR4108HS	XVR4116HS
System	Main Processor	Industrial embedded micro controller		
	OS	Embedded LINUX		
Video Parameters	Video Encode Standard	H.264		
	Encode Resolution	1080N/720P/960H/D1 /HD1/2CIF/CIF/	1080N@12f/720P@15f/960H/D1/HD1/2CI F/CIF/	
	Video Frame Rate	PAL:1~25f/s; NTSC:1~30f/s		
	Video Bit Rate	32Kbps-4096Kbps		
	Bit Stream Type	Video stream/composite stream		
	Dual-Stream	Support		
Audio Parameters	Encode Standard	G.711A/G.711U/PCM		
	Audio Sampling Rate	8KHz,16Bit		
	Audio Bit Rate	64Kbps		
Video Port	Analog Video Input	4-ch BNC port (CVBS/CVI/AHD /other analog HD video self-adaptive)	8-ch BNC port(CVBS/CVI/AHD /other analog HD video self-adaptive)	16-ch BNC port(CVBS/CVI/A HD /other analog HD video self-adaptive)
	Network Video Input	<ul style="list-style-type: none"> There is no IP channel by default. Max add 1 IP channel connection Analog /digital channel switch. Max 5 IP channel connections Connection bandwidth:0Mbps-20Mbps 	<ul style="list-style-type: none"> There is no IP channel by default. Max add 2 IP channel connections. Analog /digital channel switch. Max 10 IP channel connections Connection bandwidth:0Mbps-40Mbps 	<ul style="list-style-type: none"> There is no IP channel by default. Max add 2 IP channel connections Analog /digital channel switch. Max 18 IP channel connections Connection bandwidth:0 Mbps-56Mbps

	Parameters	XVR4104HS	XVR4108HS	XVR4116HS
				s
	Video Output	1-channel VGA output, 1-channel HDMI output (of the same video source), HDMI/ VGA video output at the same time.		
	Loop Output	N/A		
	Matrix Output	N/A		
Audio Port	Audio Input	1-channel RCA port.		
	Coaxial Audio Input	N/A		
	Audio Output	1-channel RCA port.		
	Bidirectional Talk Input	Reuse the audio input/output port.		
Record	Record Mode	Schedule record/manual record/MD record/Alarm record		
	Playback Mode	Instant playback, normal playback, event playback, mark playback, smart playback		
	Record Playback	Max 4-channel playback	Max 8-channel playback	Max 16-channel playback
	Backup Mode	HDD, burner, USB device, network backup		
Alarm	Alarm Input	N/A		
	Alarm Output	N/A		
HDD	HDD Port	1 SATA port, does not support eSATA port		
	One HDD Space	6T		
Communication Port	Network	1 RJ45 port, 100Mbps Ethernet port		
	Communication	RS485 port		
	USB	2 USB2.0 ports(One at the front panel and one at the rear panel)		
Others	Power	DC12V		
	Power Consumption (No HDD)	≤7W	≤8W	≤10W
	Working Temperature	-10℃~+55℃		
	Working Humidity	10%~90%		
	Dimensions	Compact 1U case, 260mm (W) ×220mm (D) ×44mm (H)		
	Weight (No HDD)	≤0.85KG	≤0.95KG	≤1.05KG
	Installation Mode	Desk		

1.3.65 XVR51XXHS Series

	Parameters	XVR5104HS	XVR5108HS	XVR5116HS
--	------------	-----------	-----------	-----------

	Parameters	XVR5104HS	XVR5108HS	XVR5116HS
System	Main Processor	Industrial embedded micro controller		
	OS	Embedded LINUX		
Video Parameters	Video Encode Standard	H.264		
	Encode Resolution	1080P@15f/1080N/720P/960H/D1/HD1/2CIF/CIF		
	Video Frame Rate	PAL:1~25f/s; NTSC:1~30f/s		
	Video Bit Rate	32Kbps-6144Kbps		
	Bit Stream Type	Video stream/composite stream		
	Dual-Stream	Support		
Audio Parameters	Encode Standard	G.711A/G.711U/PCM		
	Audio Sampling Rate	8KHz,16Bit		
	Audio Bit Rate	64Kbps		
Video Port	Analog Video Input	4-ch BNC port (CVBS/CVI/AHD /other analog HD video self-adaptive)	8-ch BNC port(CVBS/CVI/AHD /other analog HD video self-adaptive)	16-ch BNC port(CVBS/CVI/A HD /other analog HD video self-adaptive)
	Network Video Input	<ul style="list-style-type: none"> There is no IP channel by default. Max add 2 IP channel connections Analog /digital channel switch. Max 6 IP channel connections. Connection bandwidth:0Mbps-24Mbps 	<ul style="list-style-type: none"> There is no IP channel by default. Max add 4 IP channel connection Analog /digital channel switch. Max 12 IP channel connections. Connection bandwidth:0Mbps-48Mbps 	<ul style="list-style-type: none"> There is no IP channel by default. Max add 8 IP channel connections Analog /digital channel switch. Max 24 IP channel connections Connection bandwidth:0 Mbps-96Mbps
	Video Output	1-channel VGA output, 1-channel HDMI output (of the same video source), HDMI/ VGA video output at the same time.		
	Loop Output	N/A		
	Matrix Output	N/A		VGA/HDMI optional

	Parameters	XVR5104HS	XVR5108HS	XVR5116HS
Audio Port	Audio Input	1-channel RCA port.		
	Coaxial Audio Input	N/A		
	Audio Output	1-channel RCA port.		
	Bidirectional Talk Input	Reuse the audio input/output port of the 1 st channel.		
Record	Record Mode	Schedule record/manual record/MD record/Alarm record		
	Playback Mode	Instant playback, normal playback, event playback, mark playback, smart playback		
	Record Playback	Max 4-channel playback	Max 8-channel playback	Max 16-channel playback
	Backup Mode	HDD, burner, USB device, network backup		
Alarm	Alarm Input	N/A		
	Alarm Output	N/A		
HDD	HDD Port	1 SATA port, does not support eSATA port		
	One HDD Space	6T		
Communication Port	Network	1 RJ45 port, 100Mbps Ethernet port	1 RJ45 port, 1000Mbps Ethernet port	
	Communication	RS485 port		
	USB	2 USB2.0 ports(One at the front panel and one at the rear panel)	1 USB2.0 port and 1 USB3.0 port (One USB2.0 port at the front panel and one USB3.0 port at the rear panel)	
Others	Power	DC12V		
	Power Consumption (No HDD)	≤7W	≤8W	≤10W
	Working Temperature	-10°C ~ +55°C		
	Working Humidity	10%~90%		
	Dimensions	Compact 1U case, 260mm (W) ×220mm (D) ×44mm (H)		
	Weight (No HDD)	≤0.85KG	≤0.95KG	≤1.05KG
	Installation Mode	Desk		

1.3.66 XVR7104HS Series

	Parameters	XVR7104HS
System	Main Processor	Industrial embedded micro controller
	OS	Embedded LINUX
Video Parameters	Video Encode Standard	H.264
	Encode Resolution	1080P/720P/960H/D1/HD1/2CIF/CIF
	Video Frame Rate	PAL:1~25f/s; NTSC:1~30f/s
	Video Bit Rate	32Kbps-6144Kbps
	Bit Stream Type	Video stream/composite stream
	Dual-Stream	Support
Audio Parameters	Encode Standard	G.711A/G.711U/PCM
	Audio Sampling Rate	8KHz,16Bit
	Audio Bit Rate	64Kbps
Video Port	Analog Video Input	4-ch BNC port(CVBS/CVI/AHD /other analog HD video self-adaptive)
	Network Video Input	<ul style="list-style-type: none"> ● There is no IP channel by default. Max add 2 IP channel connections. ● Analog/digital channel switch. Max 6 IP channel connections ● Connection bandwidth: 0Mbps-24Mbps.
	Video Output	1-channel VGA output, 1-channel HDMI output (of the same video source), HDMI/ VGA video output at the same time.
	Loop Output	N/A
	Matrix Output	N/A
Audio Port	Audio Input	1-channel RCA port.
	Coaxial Audio Input	N/A
	Audio Output	1-channel RCA port.
	Bidirectional Talk Input	Reuse the audio input/output port of the 1 st channel.
Record	Record Mode	Schedule record/manual record/MD record/Alarm record
	Playback Mode	Instant playback, normal playback, event playback, mark playback, smart playback
	Backup Mode	HDD, burner, USB device, network backup
Alarm	Alarm Input	N/A
	Alarm Output	N/A
HDD	HDD Port	1 SATA port,does not support eSATA port
	One HDD Space	6T

	Parameters	XVR7104HS
Communication Port	Network	1 RJ45 port, 100Mbps Ethernet port
	Communication	RS485 port
	USB	2 USB2.0 ports(One at the front panel and one at the rear panel)
Others	Power	DC12V
	Power Consumption (No HDD)	≤8W
	Working Temperature	-10℃~+55℃
	Working Humidity	10%~90%
	Dimensions	Compact 1U case, 260mm (W) x220mm (D) x44mm (H)
	Weight (No HDD)	0.85KG
	Installation Mode	Desk

1.3.67 XVR42XXA Series

Model	Parameters	XVR4204A	XVR4208A	XVR4216A
System	Main Processor	High-performance industrial embedded micro controller		
	OS	Embedded LINUX		
Video	Video Encode Standard	H.264		
	Encode Resolution	1080N/720P/ 960H/D1/HD1/ 2CIF/CIF/	1080N@12f/720P@15f/960H/D1/HD1/2 CIF/CIF	
	Video Frame Rate	PAL:1~25f/s; NTSC:1~30f/s		
	Video Bit Rate	32Kbps~4096Kbps		
	Bit Stream Type	Video stream/composite stream		
	Dual-Stream	Support		
Audio	Encode Standard	G.711A, G.711U, PCM		
	Audio Sampling Rate	8KHz, 16Bit		
	Audio Bit Rate	64Kbps		

Model	Parameters	XVR4204A	XVR4208A	XVR4216A
Video Port	Analog Video Input	4-ch BNC port (CVBS/CVI/AHD /other analog HD video self-adaptive)	8-ch BNC port(CVBS/CVI/AHD /other analog HD video self-adaptive)	16-ch BNC port(CVBS/CVI /AHD /other analog HD video self-adaptive)
	Network Video Input	<ul style="list-style-type: none"> ● There is no IP channel by default. Max add 1 IP channel connection ● Analog /digital channel switch. Max 5 IP channel connections ● Connection bandwidth:0Mbps-20Mbps 	<ul style="list-style-type: none"> ● There is no IP channel by default. Max add 2 IP channel connections ● Analog /digital channel switch. Max 10 IP channel connections ● Connection bandwidth:0Mbps-40Mbps 	<ul style="list-style-type: none"> ● There is no IP channel by default. Max add 2 IP channel connections ● Analog /digital channel switch. Max 18 IP channel connections ● Connection bandwidth :0Mbps-56 Mbps
	Video Output	1-ch VGA output, 1-ch HDMI output, HDMI/ VGA video output at the same time (VGA/HDMI of the same video source)		
	Loop Output	N/A		
Audio Port	External Audio Input	4-ch,RCA port,		
	Coaxial Audio Input	N/A		
	Audio Output	1-ch RCA port		
	Bidirectional Talk Input	Support (Reuse the audio port of the 1 st channel)		
Record	Record Mode	Auto record, manual record, motion detect record, alarm record		

Model	Parameters	XVR4204A	XVR4208A	XVR4216A
	Playback Mode	Instant playback, normal playback, event playback, mark playback, smart playback		
	Record Playback	Max 4-ch playback	Max 8-ch playback	Max 16-ch playback
	Backup Mode	HDD, burner, flash disk, network backup.		
Alarm	Alarm Input	8-ch alarm input	8-ch alarm input	16-ch alarm input
	Alarm Output	3-ch alarm output		
HDD	HDD Port	2 SATA ports. Does not support eSATA port.		
	Space/HDD	6T		
Communication Port	Network	1 RJ45 port, 100Mbps Ethernet port		
	Communication	RS485 port		
	USB	2 USB2.0 ports(One at the front panel and one at the rear panel)		
Other	Power	DC12V		
	Power Consumption (No HDD)	≤7W	≤8W	≤10W
	Working Temperature	-10℃~+55℃		
	Working Humidity	10%~90%		
	Dimension	1U case,375mm (W) x280mm (D) x50mm (H)		
	Weight (No HDD)	≤1.5KG	≤1.65KG	≤1.8KG
	Installation Mode	Desk installation		

1.3.68 XVR42XXAN Series

Model	Parameters	XVR4204AN	XVR4208AN	XVR4216AN
System	Main Processor	High-performance industrial embedded micro controller		
	OS	Embedded LINUX		
Video	Video Encode Standard	H.264		
	Encode Resolution	1080N/720P/960H/D1/HD1/2CIF/CIF	1080N@12fps/720P@15fps/960H/D1/HD1/2CIF/CIF/	
	Video Frame Rate	PAL:1~25f/s; NTSC:1~30f/s		
	Video Bit Rate	32Kbps~4096Kbps		
	Bit Stream Type	Video stream/composite stream		
	Dual-Stream	Support		

Audio	Encode Standard	G.711A, G.711U, PCM		
	Audio Sampling Rate	8KHz,16Bit		
	Audio Bit Rate	64Kbps		
Video Port	Analog Video Input	4-ch BNC port(CVBS/CVI/AHD /other analog HD video self-adaptive)	8-ch BNC port(CVBS/CVI/AHD /other analog HD video self-adaptive)	16-ch BNC port(CVBS/CVI/AHD /other analog HD video self-adaptive)
	Network Video Input	<ul style="list-style-type: none"> There is no IP channel by default. Max add 1 IP channel connection Analog /digital channel switch. Max 5 IP channel connections Connection bandwidth:0Mbps-20Mbps 	<ul style="list-style-type: none"> There is no IP channel by default. Max add 2 IP channel connections Analog /digital channel switch. Max 10 IP channel connections Connection bandwidth:0Mbps-40Mbps 	<ul style="list-style-type: none"> There is no IP channel by default. Max add 2 IP channel connections Analog /digital channel switch. Max 18 IP channel connections Connection bandwidth:0Mbps-56Mbps
	Video Output	1-ch VGA output, 1-ch HDMI output, HDMI/ VGA video output at the same time (VGA/HDMI of the same video source)		
	Loop Output	N/A		
	Matrix Output	N/A		
	Audio Port	External Audio Input	1-ch,RCA port	
	Coaxial Audio Input	N/A		
	Audio Output	1-ch RCA port		
	Bidirectional Talk Input	Support (Reuse the audio port of the 1 st channel)		
Record	Record Mode	Auto record, manual record, motion detect record, alarm record		
	Playback Mode	Instant playback, normal playback, event playback, mark playback, smart playback		
	Record Playback	Max 16-ch playback		
	Backup Mode	HDD, burner, flash disk, network backup.		
Alarm	Alarm Input	N/A		

	Alarm Output	N/A	
HDD	HDD Port	2 SATA ports. Does not support eSATA port.	
	Space/HDD	6T	
Communication Port	Network	1 RJ45 port, 100Mbps Ethernet port	
	Communication	RS485 port	
	USB	2 USB2.0 ports(One at the front panel and one at the rear panel)	
Other	Power	DC12V	
	Power Consumption (No HDD)	≤10W	≤20W
	Working Temperature	-10℃~+55℃	
	Working Humidity	10%~90%	
	Dimension	1U case,375mm (W) x280mm (D) x50mm (H)	
	Weight (No HDD)	≤1.8KG	≤3.3KG
	Installation Mode	Desk installation	

Model	Parameters	XVR4232AN
System	Main Processor	High-performance industrial embedded micro controller
	OS	Embedded LINUX
Video	Video Encode Standard	H.264
	Encode Resolution	1080N@12fps/720P@15fps/960H/D1/HD1/2CIF/CIF/
	Video Frame Rate	PAL:1~25f/s; NTSC:1~30f/s
	Video Bit Rate	32Kbps~4096Kbps
	Bit Stream Type	Video stream/composite stream
	Dual-Stream	Support
Audio	Encode Standard	G.711A, G.711U, PCM
	Audio Sampling Rate	8KHz,16Bit
	Audio Bit Rate	64Kbps
Video Port	Analog Video Input	32-ch BNC port(CVBS/CVI/AHD/other analog HD video self-adaptive)

	Network Video Input	<ul style="list-style-type: none"> ● There is no IP channel by default. ● Analog/digital channel switch. Max 16 IP channel connections ● Connection bandwidth:0Mbps-64Mbps
	Video Output	1-ch VGA output, 1-ch HDMI output, 1-ch TV output, TV/HDMI/ VGA video output at the same time (TV/VGA/HDMI of the same video source)
	Loop Output	N/A
	Matrix Output	VGA/HDMI optional
Audio Port	External Audio Input	1-ch,RCA port
	Coaxial Audio Input	N/A
	Audio Output	1-ch RCA port
	Bidirectional Talk Input	Support (Reuse the audio port of the 1 st channel)
Record	Record Mode	Auto record, manual record, motion detect record, alarm record
	Playback Mode	Instant playback, normal playback, event playback, mark playback, smart playback(motion detect)
	Record Playback	Max 16-ch playback
	Backup Mode	HDD, burner, flash disk, network backup.
Alarm	Alarm Input	N/A
	Alarm Output	N/A
HDD	HDD Port	2 SATA ports. Does not support eSATA port.
	Space/HDD	8T
Communication Port	Network	1 RJ45 port, 1000Mbps Ethernet port
	Communication	1 RS485 port
	USB	2 USB ports(One USB2.0 port at the front panel and one USB3.0 at the rear panel)
Other	Power	DC12V
	Power Consumption (No HDD)	≤20W
	Working Temperature	-10℃~+55℃
	Working Humidity	10%~90%
	Dimension	1U case,375mm (W) ×280mm (D) ×50mm (H)
	Net Weight (No HDD)	≤2KG

	Installation Mode	Desk installation
--	--------------------------	-------------------

1.3.69 XVR52XXA Series

Model	Parameters	XVR5204A	XVR5208A	XVR5216A
System	Main Processor	High-performance industrial embedded micro controller		
	OS	Embedded LINUX		
Video	Video Encode Standard	H.264		
	Encode Resolution	1080P@15f/1080N/720P/960H/D1/HD1/2CIF/CIF		
	Video Frame Rate	PAL:1~25f/s; NTSC:1~30f/s		
	Video Bit Rate	32Kbps~6144Kbps		
	Bit Stream Type	Video stream/composite stream		
	Dual-Stream	Support		
Audio	Encode Standard	G.711A, G.711U, PCM		
	Audio Sampling Rate	8KHz,16Bit		
	Audio Bit Rate	64Kbps		
Video Port	Analog Video Input	4-ch BNC port (CVBS/CVI/AHD /other analog HD video self-adaptive)	8-ch BNC port(CVBS/CVI/AHD /other analog HD video self-adaptive)	16-ch BNC port(CVBS/CVI /AHD /other analog HD video self-adaptive)

	Network Video Input	<ul style="list-style-type: none"> ● There is no IP channel by default. Max add 2 IP channel connections ● Analog /digital channel switch. Max 6 IP channel connections ● Connection bandwidth:0Mbps-24Mbps 	<ul style="list-style-type: none"> ● There is no IP channel by default. Max add 4 IP channel connections ● Analog /digital channel switch. Max 12 IP channel connections ● Connection bandwidth:0Mbps-48Mbps 	<ul style="list-style-type: none"> ● There is no IP channel by default. Max add 8 IP channel connections ● Analog /digital channel switch. Max 24 IP channel connections ● Connection bandwidth :0Mbps-96 Mbps
	Video Output	1-ch VGA output, 1-ch HDMI output, HDMI/ VGA video output at the same time (VGA/HDMI of the same video source)		
	Loop Output	N/A		
	Matrix Output	N/A		VGA/HDMI optional
Audio Port	External Audio Input	4-ch,RCA port,		
	Coaxial Audio Input	N/A		
	Audio Output	1-ch RCA port		
	Bidirectional Talk Input	Support (Reuse the audio port of the 1 st channel)		
Record	Record Mode	Auto record, manual record, motion detect record, alarm record		
	Playback Mode	Instant playback, normal playback, event playback, mark playback, smart playback		
	Record Playback	Max 4-ch playback	Max 8-ch playback	Max 16-ch playback
	Backup Mode	HDD, burner, flash disk, network backup.		
Alarm	Alarm Input	8-ch alarm input	8-ch alarm input	16-ch alarm input

	Alarm Output	3-ch alarm output		
HDD	HDD Port	2 SATA ports. Does not support eSATA port.		
	Space/HDD	6T		
Communication Port	Network	1 RJ45 port, 100Mbps Ethernet port	1 RJ45 port, 1000Mbps Ethernet port	
	Communication	RS485 port		
	USB	2 USB2.0 ports(One at the front panel and one at the rear panel)	1 USB2.0 port and 1 USB3.0 port (One USB2.0 port at the front panel and one USB3.0 port at the rear panel)	
Other	Power	DC12V		
	Power Consumption (No HDD)	≤7W	≤8W	≤10W
	Working Temperature	-10℃~+55℃		
	Working Humidity	10%~90%		
	Dimension	1U case,375mm (W) ×280mm (D) ×50mm (H)		
	Weight (No HDD)	≤1.5KG	≤1.65KG	≤1.8KG
	Installation Mode	Desk installation		

1.3.70 XVR52XXAN Series

Model	Parameters	XVR5204AN	XVR5208AN	XVR5216AN
System	Main Processor	High-performance industrial embedded micro controller		
	OS	Embedded LINUX		
Video	Video Encode Standard	H.264		
	Encode Resolution	1080P@15f/1080N/720P/960H/D1/HD1/2CIF/CIF		
	Video Frame Rate	PAL:1~25f/s; NTSC:1~30f/s		
	Video Bit Rate	32Kbps~6144Kbps		
	Bit Stream Type	Video stream/composite stream		

	Dual-Stream	Support		
Audio	Encode Standard	G.711A, G.711U, PCM		
	Audio Sampling Rate	8KHz,16Bit		
	Audio Bit Rate	64Kbps		
Video Port	Analog Video Input	4-ch BNC port (CVBS/CVI/AHD /other analog HD video self-adaptive)	8-ch BNC port(CVBS/CVI/AHD /other analog HD video self-adaptive)	16-ch BNC port(CVBS/CVI/AHD /other analog HD video self-adaptive)
	Network Video Input	<ul style="list-style-type: none"> ● There is no IP channel by default. Max add 2 IP channel connections ● Analog /digital channel switch. Max 6 IP channel connections ● Connection bandwidth:0Mbps-24Mbps 	<ul style="list-style-type: none"> ● There is no IP channel by default. Max add 4 IP channel connections ● Analog /digital channel switch. Max 12 IP channel connections ● Connection bandwidth:0Mbps-48Mbps 	<ul style="list-style-type: none"> ● There is no IP channel by default. Max add 8 IP channel connections ● Analog /digital channel switch. Max 24 IP channel connections ● Connection bandwidth:0Mbps-96Mbps
	Video Output	1-ch VGA output, 1-ch HDMI output, HDMI/ VGA video output at the same time (VGA/HDMI of the same video source)		
	Loop Output	N/A		
	Matrix Output	N/A		VGA/HDMI optional
	Audio Port	External Audio Input	1-ch,RCA port	
Coaxial Audio Input		N/A		
Audio Output		1-ch RCA port		
Bidirectional Talk Input		Support (Reuse the audio port of the 1 st channel)		
Record	Record Mode	Auto record, manual record, motion detect record, alarm record		
	Playback Mode	Instant playback, normal playback, event playback, mark playback, smart playback		
	Record Playback	Max 16-ch playback		
	Backup Mode	HDD, burner, flash disk, network backup.		

Alarm	Alarm Input	N/A		
	Alarm Output	N/A		
HDD	HDD Port	2 SATA ports. Does not support eSATA port.		
	Space/HDD	6T		
Communication Port	Network	1 RJ45 port, 100Mbps Ethernet port	1 RJ45 port, 1000Mbps Ethernet port	
	Communication	RS485 port		
	USB	2 USB2.0 ports(One at the front panel and one at the rear panel)	1 USB2.0 port and 1 USB3.0 port (One USB2.0 port at the front panel and one USB3.0 port at the rear panel)	
Other	Power	DC12V		
	Power Consumption (No HDD)	≤7W	≤8W	≤10W
	Working Temperature	-10℃~+55℃		
	Working Humidity	10%~90%		
	Dimension	1U case,375mm (W) x280mm (D) x50mm (H)		
	Weight (No HDD)	≤1.5KG	≤1.65KG	≤1.8KG
	Installation Mode	Desk installation		

Model	Parameters	XVR5232AN
System	Main Processor	High-performance industrial embedded micro controller
	OS	Embedded LINUX
Video	Video Encode Standard	H.264
	Encode Resolution	1080P@15f/1080N/720P/960H/D1/HD1/2CIF/CIF
	Video Frame Rate	PAL:1~25f/s; NTSC:1~30f/s
	Video Bit Rate	32Kbps~6144Kbps
	Bit Stream Type	Video stream/composite stream
	Dual-Stream	Support
Audio	Encode Standard	G.711A, G.711U, PCM

	Audio Sampling Rate	8KHz,16Bit
	Audio Bit Rate	64Kbps
Video Port	Analog Video Input	32-ch BNC port (CVBS/CVI/AHD/other analog HD video self-adaptive)
	Network Video Input	<ul style="list-style-type: none"> ● There is no IP channel by default. ● Analog/digital channel switch. Max 32 IP channel connections. ● Connection bandwidth:0Mbps-128Mbps
	Video Output	1-ch VGA output, 1-ch HDMI output, 1-ch TV output, TV/HDMI/ VGA video output at the same time (TV/VGA/HDMI of the same video source)
	Loop Output	N/A
	Matrix Output	VGA/HDMI optional
Audio Port	External Audio Input	1-ch,RCA port
	Coaxial Audio Input	N/A
	Audio Output	1-ch RCA port
	Bidirectional Talk Input	Support (Reuse the audio port of the 1 st channel)
Record	Record Mode	Auto record, manual record, motion detect record, alarm record
	Playback Mode	Instant playback, normal playback, event playback, mark playback, smart playback(human face,motion detect)
	Record Playback	Max 16-ch playback
	Backup Mode	HDD, burner, flash disk, network backup.
Alarm	Alarm Input	N/A
	Alarm Output	N/A
HDD	HDD Port	2 SATA ports. Does not support eSATA port.
	Space/HDD	8T
Communication Port	Network	1 RJ45 port, 1000Mbps Ethernet port
	Communication	1 RS485 port
	USB	2 USB port (One USB2.0 port at the front panel and one USB3.0 port at the rear panel)
Other	Power	DC12V
	Power Consumption (No HDD)	≤27W
	Working Temperature	-10℃~+55℃

	Working Humidity	10%~90%
	Dimension	1U case,375mm (W) x280mm (D) x50mm (H)
	Net Weight (No HDD)	≤2KG
	Installation Mode	Desk installation

1.3.71 XVR72XXA Series

Model	Parameters	XVR7204A	XVR7208A	XVR7216A
System	Main Processor	High-performance industrial embedded micro controller		
	OS	Embedded LINUX		
Video	Video Encode Standard	H.264		
	Encode Resolution	1080P/720P/960H/D1/HD1/2CIF/CIF		
	Video Frame Rate	PAL:1~25f/s; NTSC:1~30f/s		
	Video Bit Rate	32Kbps~6144Kbps		
	Bit Stream Type	Video stream/composite stream		
	Dual-Stream	Support		
Audio	Encode Standard	G.711A, G.711U, PCM		
	Audio Sampling Rate	8KHz,16Bit		
	Audio Bit Rate	64Kbps		
Video Port	Analog Video Input	4-ch BNC port (CVBS/CVI/AHD /other analog HD video self-adaptive)	8-ch BNC port(CVBS/CVI/AHD /other analog HD video self-adaptive)	16-ch BNC port(CVBS/CVI/AHD /other analog HD video self-adaptive)

	Network Video Input	<ul style="list-style-type: none"> There is no IP channel by default. Max add 2 IP channel connections. Analog /digital channel switch. Max 6 IP channel connections Connection bandwidth:0Mbps-24Mbps 	<ul style="list-style-type: none"> There is no IP channel by default. Max add 4 IP channel connections Analog /digital channel switch. Max 12 IP channel connections Connection bandwidth:0Mbps-48Mbps 	<ul style="list-style-type: none"> There is no IP channel by default. Max add 8 IP channel connections Analog /digital channel switch. Max 24 IP channel connections Connection bandwidth:0Mbps-96Mbps
	Video Output	1-ch VGA output, 1-ch HDMI output, HDMI/ VGA video output at the same time (VGA/HDMI of the same video source)		
	Loop Output	N/A		
	Matrix Output	N/A	VGA/HDMI optional	
Audio Port	External Audio Input	4-ch,RCA port,		
	Coaxial Audio Input	N/A		
	Audio Output	1-ch RCA port		
	Bidirectional Talk Input	Support (Reuse the audio port of the 1 st channel)		
Record	Record Mode	Auto record, manual record, motion detect record, alarm record		
	Playback Mode	Instant playback, normal playback, event playback, mark playback, smart playback		
	Record Playback	Max 4-ch playback	Max 8-ch playback	Max 16-ch playback
	Backup Mode	HDD, burner, flash disk, network backup.		
Alarm	Alarm Input	8-ch alarm input	8-ch alarm input	16-ch alarm input
	Alarm Output	3-ch alarm output		
HDD	HDD Port	2 SATA ports. Does not support eSATA port.		
	Space/HDD	6T		
Communication Port	Network	1 RJ45 port, 100Mbps Ethernet port	1 RJ45 port, 1000Mbps Ethernet port	
	Communication	RS485 port		

	USB	2 USB2.0 ports(One at the front panel and one at the rear panel)	1 USB2.0 port and 1 USB3.0 port (One USB2.0 port at the front panel and one USB3.0 port at the rear panel)	
Other	Power	DC12V		
	Power Consumption (No HDD)	≤8W	≤10W	≤15W
	Working Temperature	-10℃~+55℃		
	Working Humidity	10%~90%		
	Dimension	1U case,375mm (W) x280mm (D) x50mm (H)		
	Weight (No HDD)	≤1.5KG	≤1.65KG	≤1.8KG
	Installation Mode	Desk installation		

1.3.72 XVR72XXAN Series

Model	Parameters	XVR7204AN	XVR7208AN	XVR7216AN
System	Main Processor	High-performance industrial embedded micro controller		
	OS	Embedded LINUX		
Video	Video Encode Standard	H.264		
	Encode Resolution	1080P/720P/960H/D1/HD1/2CIF/CIF		
	Video Frame Rate	PAL:1~25f/s; NTSC:1~30f/s		
	Video Bit Rate	32Kbps~6144Kbps		
	Bit Stream Type	Video stream/composite stream		
	Dual-Stream	Support		
Audio	Encode Standard	G.711A, G.711U, PCM		
	Audio Sampling Rate	8KHz,16Bit		
	Audio Bit Rate	64Kbps		
Video Port	Analog Video Input	4-ch BNC port (CVBS/CVI/AHD /other analog HD video self-adaptive)	8-ch BNC port(CVBS/CVI/AHD /other analog HD video self-adaptive)	16-ch BNC port(CVBS/CVI/AHD /other analog HD video self-adaptive)

	Network Video Input	<ul style="list-style-type: none"> There is no IP channel by default. Max add 2 IP channel connections. Analog /digital channel switch. Max 6 IP channel connections Connection bandwidth:0Mbps-24Mbps 	<ul style="list-style-type: none"> There is no IP channel by default. Max add 4 IP channel connections Analog /digital channel switch. Max 12 IP channel connections Connection bandwidth:0Mbps-48Mbps 	<ul style="list-style-type: none"> There is no IP channel by default. Max add 8 IP channel connections Analog /digital channel switch. Max 24 IP channel connections Connection bandwidth:0Mbps-96Mbps
	Video Output	1-ch VGA output, 1-ch HDMI output, HDMI/ VGA video output at the same time (VGA/HDMI of the same video source)		
	Loop Output	N/A		
	Matrix Output	N/A	VGA/HDMI optional	
Audio Port	External Audio Input	1-ch,RCA port,		
	Coaxial Audio Input	N/A		
	Audio Output	1-ch RCA port		
	Bidirectional Talk Input	Support (Reuse the audio port of the 1 st channel)		
Record	Record Mode	Auto record, manual record, motion detect record, alarm record		
	Playback Mode	Instant playback, normal playback, event playback, mark playback, smart playback		
	Record Playback	Max 4-ch playback	Max 8-ch playback	Max 16-ch playback
	Backup Mode	HDD, burner, flash disk, network backup.		
Alarm	Alarm Input	N/A		
	Alarm Output	N/A		
HDD	HDD Port	2 SATA ports. Does not support eSATA port.		
	Space/HDD	6T		
Communication Port	Network	1 RJ45 port, 100Mbps Ethernet port	1 RJ45 port, 1000Mbps Ethernet port	
	Communication	RS485 port		

	USB	2 USB2.0 ports(One at the front panel and one at the rear panel)	1 USB2.0 port and 1 USB3.0 port (One USB2.0 port at the front panel and one USB3.0 port at the rear panel)	
Other	Power	DC12V		
	Power Consumption (No HDD)	≤8W	≤10W	≤15W
	Working Temperature	-10℃~+55℃		
	Working Humidity	10%~90%		
	Dimension	1U case,375mm (W) x280mm (D) x50mm (H)		
	Weight (No HDD)	≤1.5KG	≤1.65KG	≤1.8KG
	Installation Mode	Desk installation		

1.3.73 XVR54XXL Series

Model	Parameters	XVR5408L	XVR5416L	XVR5432L
System	Main Processor	High-performance industrial embedded micro controller		
	OS	Embedded LINUX		
Video	Video Encode Standard	H.264H, H.264, H.264B		
	Encode Resolution	1080P@15fps/1080N/720P/960H/D1/HD1/2CIF/CIF		
	Video Frame Rate	PAL:1~25f/s; NTSC:1~30f/s		
	Video Bit Rate	32Kbps~6144Kbps (For 720P:default value is 2Mbps,max value is 4Mbps. For 1080P:default value is 2Mbps,max value is 6Mbps)		
	Bit Stream Type	Video stream/composite stream		
	Dual-Stream	Support		
Audio	Encode Standard	G.711A, G.711U, PCM		
	Audio Sampling Rate	8KHz,16Bit		
	Audio Bit Rate	64Kbps		

Video Port	Analog Video Input	8-ch BNC port (HDCVI HD video/general standard definition video self-adaptive)	16-ch BNC port(HDCVI HD video/general standard definition video self-adaptive)	32-ch BNC port(HDCVI HD video/general standard definition video self-adaptive)
	Network Video Input	<ul style="list-style-type: none"> Support 4 IP channels by default. Analog /digital channel switch. Max 12 IP channel connections. Connection bandwidth:16Mbps-48Mbps 	<ul style="list-style-type: none"> Support 8 IP channels by default. Analog /digital channel switch. Max 24 IP channel connections. Connection bandwidth:32Mbps-96Mbps 	<ul style="list-style-type: none"> There is no IP channel by default. Analog /digital channel switch. Max 32 IP channel connections. Connection bandwidth:0Mbps-128Mbps
	Video Output	1-ch VGA output, 1-ch HDMI output, 1-ch TV output, HDMI/VGA/TV video output at the same time (HDMI/VGA/TV of the same video source)	1-ch VGA output, 2-ch HDMI output, 1-ch TV output, HDMI1/VGA/TV video output at the same time (HDMI1/VGA/TV of the same video source)	1-ch VGA output, 2-ch HDMI output, 1-ch TV output, HDMI1/VGA/TV video output at the same time (HDMI1/VGA/TV of the same video source)
	Loop Output	N/A		
	Matrix Output	N/A	HDMI2 port support matrix output	
Audio Port	External Audio Input	4-channel BNC port,		
	Coaxial Audio Input	8-channel	16-channel	32-channel
	Audio Output	1-ch BNC port		
	Bidirectional Talk Input	Support (Independent bidirectional talk port)		
Record	Record Mode	Card number record, mark record, alarm record, motion detection record, regular record, manual record, intelligent record.		
	Playback Mode	Instant playback, normal playback, event playback, mark playback, intelligent playback.		
	Record Playback	Max 8-ch playback	Max 16-ch playback	
	Backup Mode	HDD, burner, flash disk, network backup.		
Alarm	Alarm Input	8-channel	16-channel	
	Alarm Output	6-channel		

HDD	HDD Port	4 SATA ports. Support eSATA port.		
	Space/HDD	8T		
Communication Port	Network	1 RJ45 port, 1000Mbps Ethernet port		
	Communication	1 RS232 port, 1 RS422 port, 1 RS485 port		
	USB	3 USB ports(One at the front panel and two at the rear panel)	3 USB ports (One at the front panel and two at the rear panel. The rear panel supports USB3.0)	
Other	Power	AC100-240V 1.9A 50/60Hz		
	Power Consumption (No HDD)	30W (No HDD)		
	Working Temperature	-10℃~+55℃		
	Working Humidity	10%~90%		
	Dimension	1.5U case,440mm (W) x410mm (D) x70mm (H)		
	Weight (No HDD)	≤7KG (No HDD)	≤7.2KG (No HDD)	≤7.5KG (No HDD)
	Installation Mode	Desk installation		

1.3.74 XVR74XXL Series

Model	Parameters	XVR7408L	XVR7416L
System	Main Processor	High-performance industrial embedded micro controller	
	OS	Embedded LINUX	
Video	Video Encode Standard	H.264H, H.264, H.264B	
	Encode Resolution	1080P/720P/960H/D1/HD1/2CIF/CIF/	
	Video Frame Rate	PAL:1~25f/s; NTSC:1~30f/s	
	Video Bit Rate	32Kbps~6144Kbps (For 720P:default value is 2Mbps,max value is 4Mbps. For 1080P:default value is 4Mbps,max value is 6Mbps)	
	Bit Stream Type	Video stream/composite stream	
	Dual-Stream	Support	
Audio	Encode Standard	G.711A, G.711U, PCM	
	Audio Sampling Rate	8KHz,16Bit	
	Audio Bit Rate	64Kbps	

Video Port	Analog Video Input	8-ch BNC port (HDCVI HD video/general standard definition video self-adaptive)	16-ch BNC port(HDCVI HD video/general standard definition video self-adaptive)
	Network Video Input	<ul style="list-style-type: none"> ● Support 4 IP channels by default. ● Analog /digital channel switch. Max 12 IP channel connections. ● Connection bandwidth:16Mbps-48Mbps 	<ul style="list-style-type: none"> ● Support 8 IP channels by default. ● Analog /digital channel switch. Max 24 IP channel connections. ● Connection bandwidth:32Mbps-96Mbps
	Video Output	1-ch VGA output, 2-ch HDMI output, 1-ch TV output, HDMI1/VGA/TV video output at the same time (HDMI1/VGA/TV of the same video source)	
	Loop Output	N/A	
	Matrix Output	N/A	HDMI2 port support matrix output
Audio Port	External Audio Input	4-channel BNC port,	
	Coaxial Audio Input	8-channel	16-channel
	Audio Output	1-channel BNC port	
	Bidirectional Talk Input	Support (Independent bidirectional talk port)	
Record	Record Mode	Card number record, mark record, alarm record, motion detection record, regular record, manual record, intelligent record.	
	Playback Mode	Instant playback, normal playback, event playback, mark playback, intelligent playback.	
	Record Playback	Max 8-ch playback	Max 16-ch playback
	Backup Mode	HDD, burner, flash disk, network backup.	
Alarm	Alarm Input	16-channel	
	Alarm Output	6-channel	
HDD	HDD Port	4 SATA ports. Support eSATA port.	
	Space/HDD	8T	
Communication Port	Network	1 RJ45 port, 1000Mbps Ethernet port	
	Communication	1 RS232 port, 1 RS422 port, 1 RS485 port	
	USB	3 USB ports (One at the front panel and two at the rear panel. The rear panel supports USB3.0)	
Other	Power	AC100-240V 1.9A 50/60Hz	

	Power Consumption (No HDD)	30W (No HDD)	
	Working Temperature	-10℃~+55℃	
	Working Humidity	10%~90%	
	Dimension	1.5U case,440mm (W) ×410mm (D) ×70mm (H)	
	Weight (No HDD)	≤7KG (No HDD)	≤7.2KG (No HDD)
	Installation Mode	Desk installation	

1.3.75 XVR58XXS Series

Model	Parameters	XVR5808S	XVR5816S	XVR5832S
System	Main Processor	High-performance industrial embedded micro controller		
	OS	Embedded LINUX		
Video	Video Encode Standard	H.264H, H.264, H.264B		
	Encode Resolution	1080P@15fps/1080N/720P/960H/D1/HD1/2CIF/CIF		
	Video Frame Rate	PAL:1~25f/s; NTSC:1~30f/s		
	Video Bit Rate	32Kbps~6144Kbps (For 720P:default value is 2Mbps,max value is 4Mbps. For 1080P:default value is 2Mbps,max value is 6Mbps)		
	Bit Stream Type	Video stream/composite stream		
	Dual-Stream	Support		
Audio	Encode Standard	G.711A, G.711U, PCM		
	Audio Sampling Rate	8KHz,16Bit		
	Audio Bit Rate	64Kbps		
Video Port	Analog Video Input	8-ch BNC port (HDCVI HD video/general standard definition video self-adaptive)	16-ch BNC port(HDCVI HD video/general standard definition video self-adaptive)	32-ch BNC port(HDCVI HD video/general standard definition video self-adaptive)

	Network Video Input	<ul style="list-style-type: none"> ● Support 4 IP channels by default. ● Analog /digital channel switch. Max 12 IP channel connections. ● Connection bandwidth:16Mbps-48Mbps 	<ul style="list-style-type: none"> ● Support 8 IP channels by default. ● Analog /digital channel switch. Max 24 IP channel connections. ● Connection bandwidth:32Mbps-96Mbps 	<ul style="list-style-type: none"> ● There is no IP channel by default. ● Analog /digital channel switch. Max 32 IP channel connections. ● Connection bandwidth:0Mbps-128Mbps
	Video Output	1-ch VGA output, 1-ch HDMI output, 1-ch TV output, HDMI/VGA/TV video output at the same time (HDMI/VGA/TV of the same video source)	1-ch VGA output, 2-ch HDMI output, 1-ch TV output, HDMI1/VGA/TV video output at the same time (HDMI1/VGA/TV of the same video source)	1-ch VGA output, 2-ch HDMI output, 1-ch TV output, HDMI1/VGA/TV video output at the same time (HDMI1/VGA/TV of the same video source)
	Loop Output	N/A		
	Matrix Output	N/A	HDMI2 port support matrix output	
Audio Port	External Audio Input	8-channel BNC port,		
	Coaxial Audio Input	8-channel	16-channel	32-channel
	Audio Output	1-ch BNC port		
	Bidirectional Talk Input	Support (Independent bidirectional talk port)		
Record	Record Mode	Card number record, mark record, alarm record, motion detection record, regular record, manual record, intelligent record.		
	Playback Mode	Instant playback, normal playback, event playback, mark playback, intelligent playback.		
	Record Playback	Max 8-ch playback	Max 16-ch playback	
	Backup Mode	HDD, burner, flash disk, network backup.		
Alarm	Alarm Input	8-channel	16-channel	
	Alarm Output	6-channel		
HDD	HDD Port	8 SATA ports. Support eSATA port.		
	Space/HDD	8T		

Communication Port	Network	1 RJ45 port, 1000Mbps Ethernet port	2 RJ45 ports, 1000Mbps Ethernet port	
	Communication	1 RS232 port, 1 RS422 port, 1 RS485 port		
	USB	4 USB ports(Two at the front panel and two at the rear panel)	4 USB ports (Two at the front panel and two at the rear panel. The rear panel supports USB3.0)	
Other	Power	AC100-240V 1.9A 50/60Hz		
	Power Consumption (No HDD)	35W (No HDD)		
	Working Temperature	-10℃~+55℃		
	Working Humidity	10%~90%		
	Dimension	2U case,440mm (W) x460mm (D) x89mm (H)		
	Weight (No HDD)	≤9KG (No HDD)	≤9.2KG (No HDD)	≤9.4KG (No HDD)
	Installation Mode	Desk installation		

1.3.76 XVR78XXS Series

Model	Parameters	XVR7808S	XVR7816S
System	Main Processor	High-performance industrial embedded micro controller	
	OS	Embedded LINUX	
Video	Video Encode Standard	H.264H, H.264, H.264B	
	Encode Resolution	1080P/720P/960H/D1/HD1/2CIF/CIF/	
	Video Frame Rate	PAL:1~25f/s; NTSC:1~30f/s	
	Video Bit Rate	32Kbps~6144Kbps (For 720P:default value is 2Mbps,max value is 4Mbps. For 1080P:default value is 4Mbps,max value is 6Mbps)	
	Bit Stream Type	Video stream/composite stream	
	Dual-Stream	Support	
Audio	Encode Standard	G.711A, G.711U, PCM	
	Audio Sampling Rate	8KHz,16Bit	
	Audio Bit Rate	64Kbps	

Video Port	Analog Video Input	8-ch BNC port (HDCVI HD video/general standard definition video self-adaptive)	16-ch BNC port(HDCVI HD video/general standard definition video self-adaptive)
	Network Video Input	<ul style="list-style-type: none"> ● Support 4 IP channels by default. ● Analog /digital channel switch. Max 12 IP channel connections. ● Connection bandwidth:16Mbps-48Mbps 	<ul style="list-style-type: none"> ● Support 8 IP channels by default. ● Analog /digital channel switch. Max 24 IP channel connections. ● Connection bandwidth:32Mbps-96Mbps
	Video Output	1-ch VGA output, 2-ch HDMI output, 1-ch TV output, HDMI1/VGA/TV video output at the same time (HDMI1/VGA/TV of the same video source)	
	Loop Output	N/A	
	Matrix Output	HDMI2 port support matrix output	
Audio Port	External Audio Input	8-channel BNC port,	16-channel BNC port,
	Coaxial Audio Input	8-channel	16-channel
	Audio Output	1-ch BNC port	
	Bidirectional Talk Input	Support (Independent bidirectional talk port)	
Record	Record Mode	Card number record, mark record, alarm record, motion detection record, regular record, manual record, intelligent record.	
	Playback Mode	Instant playback, normal playback, event playback, mark playback, intelligent playback.	
	Record Playback	Max 8-ch playback	Max 16-ch playback
	Backup Mode	HDD, burner, flash disk, network backup.	
Alarm	Alarm Input	16-channel	
	Alarm Output	6-channel	
HDD	HDD Port	8 SATA ports. Support eSATA port.	
	Space/HDD	8T	
Communication Port	Network	2 RJ45 ports, 1000Mbps Ethernet port	
	Communication	1 RS232 port, 1 RS422 port, 1 RS485 port	
	USB	4 USB ports (Two at the front panel and two at the rear panel. The rear panel supports USB3.0)	
Other	Power	AC100-240V 1.9A 50/60Hz	

	Power Consumption (No HDD)	35W (No HDD)	
	Working Temperature	-10°C ~ +55°C	
	Working Humidity	10%~90%	
	Dimension	2U case,440mm (W) x460mm (D) x89mm (H)	
	Weight (No HDD)	9KG (No HDD)	9.2KG (No HDD)
	Installation Mode	Desk installation	

1.3.77 HCVR710XH-4K Series

Model	Parameters	HCVR7104H-4K	HCVR7108H-4K
System	Main Processor	High-performance industrial embedded micro controller	
	OS	Embedded LINUX	
Video	Video Encode Standard	H.264+/H.264	
	Encode Resolution	Main stream: 4K(3840*2160)/2K(2560*1440)/1080P/720P/960H/D1/HD1/BCIF/ CIF/QCIF; Sub stream: D1/CIF/QCIF	
	Video Frame Rate	4K: PAL:1~12f/s; NTSC: 1~15f/s Other resolution: PAL:1~25f/s; NTSC:1~30f/s	
	Video Bit Rate	32Kbps~8192Kbps (For 720P:default value is 2Mbps,max value is 4Mbps; For 1080P:default value is 4Mbps,max value is 6Mbps; For 2K:default value is 6Mbps,max value is 6Mbps; For 4K@15frame:default value is 8Mbps,max value is 8Mbps;)	
	Bit Stream Type	Video stream/composite stream	
	Dual-Stream	Support	
Audio	Encode Standard	G.711A, G.711U, PCM	
	Audio Sampling Rate	8KHz,16Bit	
	Audio Bit Rate	64Kbps	
Video Port	Analog Video Input	4-ch BNC port (HDCVI/CVBS)	8-ch BNC port (HDCVI/CVBS)

	Network Video Input	<ul style="list-style-type: none"> ● Support 2 IP channels by default. ● Analog /digital channel switch. Max 6 IP channel connections. ● Connection bandwidth:8Mbps-24Mbps 	<ul style="list-style-type: none"> ● Support 4 IP channels by default. ● Analog /digital channel switch. Max 12 IP channel connections. ● Connection bandwidth:16Mbps-48Mbps
	Video Output	1-ch VGA output, 1-ch HDMI output(Max 4K: (3840*2160)@30frames), HDMI/VGA video output the same video source or the different video sources at the same time.	
	Loop Output	N/A	
	Matrix Output	When HDMI and VGA output the different video source, one port supports matrix output.	
Audio Port	External Audio Input	1-channel RCA port	1-channel RCA port
	Coaxial Audio Input	N/A	
	Audio Output	1-channel RCA port	
	Bidirectional Talk Input	Reuse audio input and output port.	
Record	Record Mode	Alarm record, motion detection record, regular record, manual record, intelligent record.	
	Playback Mode	Instant playback, normal playback, event playback, mark playback, intelligent playback	
	Record Playback	Max 4-ch playback	Max 8-ch playback
	Backup Mode	HDD, burner, flash disk, network backup.	
Alarm	Alarm Input	N/A	
	Alarm Output	N/A	
HDD	HDD Port	1 SATA port.	
	Space/HDD	8T	
Communication Port	Network	1 RJ45 port, 1000Mbps Ethernet port	
	Communication	1 RS485 port	
	USB	2 USB ports (One USB2.0 port at the front panel and one USB3.0 port at the rear panel.)	
Other	Power	DC12V	
	Power Consumption (No HDD)	≤13W	≤20W

	Working Temperature	-10℃~+55℃	
	Working Humidity	10%~95%	
	Dimension	325mm(W)×245mm(D)×45mm(H)	
	Weight (No HDD)	≤1.25KG	≤1.40KG
	Installation Mode	Desk installation	

1.3.78 HCVR720XAN-4K Series

Model	Parameters	HCVR7204AN-4K	HCVR7208AN-4K
System	Main Processor	High-performance industrial embedded micro controller	
	OS	Embedded LINUX	
Video	Video Encode Standard	H.264+/H.264	
	Encode Resolution	Main stream: 4K(3840*2160)/2K(2560*1440)/1080P/720P/960H/D1/HD1/BCIF/ CIF/QCIF; Sub stream: D1/CIF/QCIF	
	Video Frame Rate	4K: PAL:1~12f/s; NTSC: 1~15f/s Other resolution: PAL:1~25f/s; NTSC:1~30f/s	
	Video Bit Rate	32Kbps~8192Kbps (For 720P:default value is 2Mbps,max value is 4Mbps; For 1080P:default value is 4Mbps,max value is 6Mbps; For 2K:default value is 6Mbps,max value is 6Mbps; For 4K@15frame:default value is 8Mbps,max value is 8Mbps;)	
	Bit Stream Type	Video stream/composite stream	
	Dual-Stream	Support	
Audio	Encode Standard	G.711A, G.711U, PCM	
	Audio Sampling Rate	8KHz,16Bit	
	Audio Bit Rate	64Kbps	
Video Port	Analog Video Input	4-ch BNC port (HDCVI/CVBS)	8-ch BNC port (HDCVI/CVBS)

	Network Video Input	<ul style="list-style-type: none"> ● Support 2 IP channels by default. ● Analog /digital channel switch. Max 6 IP channel connections. ● Connection bandwidth:8Mbps-24Mbps 	<ul style="list-style-type: none"> ● Support 4 IP channels by default. ● Analog /digital channel switch. Max 12 IP channel connections. ● Connection bandwidth:16Mbps-48Mbps
	Video Output	1-ch VGA output, 1-ch HDMI output(Max 4K: (3840*2160)@30frames), HDMI/VGA video output the same video source or the different video sources at the same time.	
	Loop Output	N/A	
	Matrix Output	When HDMI and VGA output the different video source, one port supports matrix output.	
Audio Port	External Audio Input	1-channel RCA port	1-channel RCA port
	Coaxial Audio Input	N/A	
	Audio Output	1-channel RCA port	
	Bidirectional Talk Input	Reuse audio input and output port.	
Record	Record Mode	Alarm record, motion detection record, regular record, manual record, intelligent record.	
	Playback Mode	Instant playback, normal playback, event playback, mark playback, intelligent playback	
	Record Playback	Max 4-ch playback	Max 8-ch playback
	Backup Mode	HDD, burner, flash disk, network backup.	
Alarm	Alarm Input	N/A	
	Alarm Output	N/A	
HDD	HDD Port	2 SATA ports.	
	Space/HDD	8T	
Communication Port	Network	1 RJ45 port, 1000Mbps Ethernet port	
	Communication	1 RS485 port	
	USB	2 USB ports (One USB2.0 port at the front panel and one USB3.0 port at the rear panel.)	
Other	Power	DC12V	
	Power Consumption (No HDD)	≤13W	≤20W

	Working Temperature	-10℃~+55℃	
	Working Humidity	10%~95%	
	Dimension	1U case, 375mm(W)×280mm(D)×50mm(H)	
	Weight (No HDD)	≤1.60KG	≤1.75KG
	Installation Mode	Desk installation	

1.3.79 XVR5104C-4M/XVR5104HS-4M/XVR5104H-4M Series

Model	Parameters	XVR5104C-4M	XVR5104HS-4M	XVR5104H-4M
System	Main Processor	High-performance industrial embedded micro controller		
	OS	Embedded LINUX		
Video	Video Encode Standard	H.264		
	Encode Resolution	2560*1440@15fps/2048*1536@15fps/1080P/720P/960H/D1/CIF/QCIF		
	Video Frame Rate	PAL:1~25f/s;NTSC:1~30f/s		
	Video Bit Rate	32Kbps~6144 Kbps		
	Bit Stream Type	Video stream/composite stream		
	Dual-Stream	Support. (Sub-stream max supports 960H encode.)		
Audio	Encode Standard	G.711A, G.711U, PCM, AAC (AAC for the first channel only)		
	Audio Sampling Rate	8KHz, 16Bit		
	Audio Bit Rate	64Kbps		
Video Port	Analog Video Input	4-ch BNC port (HDCVI/AHD/TVI/CVBS self-adaptive)		
	Network Video Input	<ul style="list-style-type: none"> ● Support 0 IP channel by default. ● Max 6 IP channels connections (Add 2 IP channels and 4-channel analog/digital channel switch.). ● Connection bandwidth: 0Mbps-24Mbps. 		
	Video Output	1-ch VGA output, 1-ch HDMI output, HDMI/VGA video output at the same time.		
	Loop Output	N/A		
	Matrix Output	N/A		
Audio Port	External Audio Input	1-channel RCA port		

	Coaxial Audio Input	4-channel BNC port		
	Audio Output	1-channel RCA port		
	Bidirectional Talk Input	Reuse audio input and output port of the first channel.		
Record	Record Mode	Alarm record, motion detection record, regular record, manual record, schedule record.		
	Playback Mode	Instant playback, normal playback, event playback, mark playback, intelligent playback.		
	Record Playback	Max 4-ch playback		
	Backup Mode	HDD, burner, flash disk, network backup.		
Alarm	Alarm Input	N/A		
	Alarm Output	N/A		
HDD	HDD Port	1 SATA port		
	Space/HDD	8T		
Communication Port	Network	1 RJ45 port, 100Mbps Ethernet port		
	Communication	N/A	1 RS485 port	
	USB	2 USB2.0 ports (Two USB2.0 ports at the rear panel.)	2 USB2.0 ports (One USB2.0 port at the front panel and one USB2.0 port at the rear panel.)	
Other	Power	DC12V		
	Power Consumption (No HDD)	≤8W		
	Working Temperature	-10℃~+55℃		
	Working Humidity	10%~90%		
	Dimension	SMART 1U case, 270mm*205mm*41 mm (W*D*H)	Compact 1U case, 260mm*220mm*44 mm (W*D*H)	Mini 1U case, 325mm*245mm*45 mm (W*D*H)
	Weight (No HDD)	≤0.55KG	≤0.90KG	≤1.10KG
	Installation Mode	Desk installation		

1.3.80 XVR5204AN-4M Series

Model	Parameters	XVR5204AN-4M
System	Main Processor	High-performance industrial embedded micro controller
	OS	Embedded LINUX
Video	Video Encode Standard	H.264

	Encode Resolution	2560*1440@15fps/2048*1536@15fps/1080P/720P/960H/D1/CIF/QCIF
	Video Frame Rate	PAL:1~25f/s;NTSC:1~30f/s
	Video Bit Rate	32Kbps~6144 Kbps
	Bit Stream Type	Video stream/composite stream
	Dual-Stream	Support. (Sub-stream max supports 960H encode.)
Audio	Encode Standard	G.711A, G.711U, PCM, AAC (AAC for the first channel only)
	Audio Sampling Rate	8KHz, 16Bit
	Audio Bit Rate	64Kbps
Video Port	Analog Video Input	4-ch BNC port (HDCVI/AHD/TVI/CVBS self-adaptive)
	Network Video Input	<ul style="list-style-type: none"> ● Support 0 IP channel by default. ● Max 6 IP channels connections (Add 2 IP channels and 4-channel analog/digital channel switch.). ● Connection bandwidth: 0Mbps-24Mbps.
	Video Output	1-ch VGA output, 1-ch HDMI output, HDMI/VGA video output at the same time.
	Loop Output	N/A
	Matrix Output	N/A
Audio Port	External Audio Input	1-channel RCA port
	Coaxial Audio Input	4-channel BNC port
	Audio Output	1-channel RCA port
	Bidirectional Talk Input	Reuse audio input and output port of the first channel.
Record	Record Mode	Alarm record, motion detection record, regular record, manual record, schedule record.
	Playback Mode	Instant playback, normal playback, event playback, mark playback, intelligent playback.
	Record Playback	Max 4-ch playback
	Backup Mode	HDD, burner, flash disk, network backup.
Alarm	Alarm Input	N/A
	Alarm Output	N/A
HDD	HDD Port	2 SATA ports
	Space/HDD	8T

Communication Port	Network	1 RJ45 port, 100Mbps Ethernet port
	Communication	1 RS485 port
	USB	2 USB2.0 ports (One USB2.0 port at the front panel and one USB2.0 port at the rear panel.)
Other	Power	DC12V
	Power Consumption (No HDD)	≤8W
	Working Temperature	-10℃~+55℃
	Working Humidity	10%~90%
	Dimension	1U case, 375mm*280mm*50mm (W*D*H)
	Weight (No HDD)	≤1.50KG
	Installation Mode	Desk installation

1.3.81 XVR5108HS-4KL/XVR5108H-4KL/XVR5116H-4KL Series

Model	Parameters	XVR5108HS-4KL	XVR5108H-4KL	XVR5116H-4KL
System	Main Processor	High-performance industrial embedded micro controller		
	OS	Embedded LINUX		
Video	Video Encode Standard	H.264		
	Encode Resolution	3840*2160@7fps/2592*1944@12fps/2560*1440@15fps/2048*1536@15fps/1080P/720P/960H/D1/CIF/QCIF		
	Video Frame Rate	PAL:1~25f/s;NTSC:1~30f/s		
	Video Bit Rate	32Kbps~8192Kbps		
	Bit Stream Type	Video stream/composite stream		
	Dual-Stream	Support. (Sub-stream max supports 960H encode.)		
Audio	Encode Standard	G.711A, G.711U, PCM, AAC (AAC for the first channel only)		
	Audio Sampling Rate	8KHz, 16Bit		
	Audio Bit Rate	64Kbps		
Video Port	Analog Video Input	8-ch BNC port (HDCVI/AHD/TVI/CVBS self-adaptive)	16-ch BNC port (HDCVI/AHD/TVI/CVBS self-adaptive)	

	Network Video Input	<ul style="list-style-type: none"> ● Support 0 IP channel by default. ● Max 12 IP channels connections (Add 4 IP channels and 8-channel analog/digital channel switch.). ● Connection bandwidth: 0Mbps-48Mbps. 	<ul style="list-style-type: none"> ● Support 0 IP channel by default. ● Max 24 IP channels connections (Add 8 IP channels and 16-channel analog/digital channel switch.). ● Connection bandwidth: 0Mbps-96Mbps.
	Video Output	1-ch VGA output, 1-ch HDMI output, HDMI/VGA video output at the same time.	
	Loop Output	N/A	
	Matrix Output	Support (VGA/HDMI optional)	
Audio Port	External Audio Input	1-channel RCA port	
	Coaxial Audio Input	8-channel BNC port	16-channel BNC port
	Audio Output	1-channel RCA port	
	Bidirectional Talk Input	Reuse audio input and output port of the first channel.	
Record	Record Mode	Alarm record, motion detection record, regular record, manual record, schedule record.	
	Playback Mode	Instant playback, normal playback, event playback, mark playback, intelligent playback.	
	Record Playback	Max 8-ch playback	Max 16-ch playback
	Backup Mode	HDD, burner, flash disk, network backup.	
Alarm	Alarm Input	N/A	
	Alarm Output	N/A	
HDD	HDD Port	1 SATA port	
	Space/HDD	8T	
Communication Port	Network	1 RJ45 port, 1000Mbps Ethernet port	
	Communication	1 RS485 port	
	USB	2 USB ports (One USB2.0 port at the front panel and one USB3.0 port at the rear panel.)	

Other	Power	DC12V		
	Power Consumption (No HDD)	≤10W		≤15W
	Working Temperature	-10°C ~ +55°C		
	Working Humidity	10%~90%		
	Dimension	Mini 1U case, 325mm*245mm*45mm (W*D*H)		
	Weight (No HDD)	≤1.1KG	≤1.25KG	≤1.45KG
	Installation Mode	Desk installation		

1.3.82 XVR5208AN-4KL/XVR5216AN-4KL Series

Model	Parameters	XVR5208AN-4KL	XVR5216AN-4KL
System	Main Processor	High-performance industrial embedded micro controller	
	OS	Embedded LINUX	
Video	Video Encode Standard	H.264	
	Encode Resolution	3840*2160@7fps/2592*1944@12fps/2560*1440@15fps/2048*1536@15fps/1080P/720P/960H/D1/CIF/QCIF	
	Video Frame Rate	PAL:1~25f/s;NTSC:1~30f/s	
	Video Bit Rate	32Kbps~8192Kbps	
	Bit Stream Type	Video stream/composite stream	
	Dual-Stream	Support. (Sub-stream max supports 960H encode.)	
Audio	Encode Standard	G.711A, G.711U, PCM, AAC (AAC for the first channel only)	
	Audio Sampling Rate	8KHz, 16Bit	
	Audio Bit Rate	64Kbps	
Video Port	Analog Video Input	8-ch BNC port (HDCVI/AHD/TVI/CVBS self-adaptive)	16-ch BNC port (HDCVI/AHD/TVI/CVBS self-adaptive)

	Network Video Input	<ul style="list-style-type: none"> ● Support 0 IP channel by default. ● Max 12 IP channels connections (Add 4 IP channels and 8-channel analog/digital channel switch.). ● Connection bandwidth: 0Mbps-48Mbps. 	<ul style="list-style-type: none"> ● Support 0 IP channel by default. ● Max 24 IP channels connections (Add 8 IP channels and 16-channel analog/digital channel switch.). ● Connection bandwidth: 0Mbps-96Mbps.
	Video Output	1-ch VGA output, 1-ch HDMI output, HDMI/VGA video output at the same time.	
	Loop Output	N/A	
	Matrix Output	Support (VGA/HDMI optional)	
Audio Port	External Audio Input	1-channel RCA port	
	Coaxial Audio Input	8-channel BNC port	16-channel BNC port
	Audio Output	1-channel RCA port	
	Bidirectional Talk Input	Reuse audio input and output port of the first channel.	
Record	Record Mode	Alarm record, motion detection record, regular record, manual record, schedule record.	
	Playback Mode	Instant playback, normal playback, event playback, mark playback, intelligent playback.	
	Record Playback	Max 8-ch playback	Max 16-ch playback
	Backup Mode	HDD, burner, flash disk, network backup.	
Alarm	Alarm Input	N/A	
	Alarm Output	N/A	
HDD	HDD Port	2 SATA ports	
	Space/HDD	8T	
Communication Port	Network	1 RJ45 port, 1000Mbps Ethernet port	
	Communication	1 RS485 port	
	USB	2 USB ports (One USB2.0 port at the front panel and one USB3.0 port at the rear panel.)	
Other	Power	DC12V	
	Power Consumption (No HDD)	≤10W	≤15W
	Working Temperature	-10℃~+55℃	

	Working Humidity	10%~90%	
	Dimension	1U case, 375mm*280mm*50mm (W*D*H)	
	Weight (No HDD)	≤1.65KG	≤1.80KG
	Installation Mode	Desk installation	

1.3.83 XVR7104HE-4KL/XVR7108HE-4KL/XVR7116HE-4KL Series

Model	Parameters	XVR7104HE-4KL	XVR7108HE-4KL	XVR7116HE-4KL
System	Main Processor	High-performance industrial embedded micro controller		
	OS	Embedded LINUX		
Video	Video Encode Standard	H.264		
	Encode Resolution	3840*2160@7fps/2592*1944@12fps/2560*1440@15fps/2048*1536@15fps/1080P/720P/960H/D1/CIF/QCIF		
	Video Frame Rate	PAL:1~25f/s;NTSC:1~30f/s		
	Video Bit Rate	32Kbps~8192Kbps		
	Bit Stream Type	Video stream/composite stream		
	Dual-Stream	Support. (Sub-stream max supports 960H encode.)		
Audio	Encode Standard	G.711A, G.711U, PCM, AAC (AAC for the first channel only)		
	Audio Sampling Rate	8KHz, 16Bit		
	Audio Bit Rate	64Kbps		
Video Port	Analog Video Input	4-ch BNC port (HDCVI/AHD/TVI/C VBS self-adaptive)	8-ch BNC port (HDCVI/AHD/TVI/C VBS self-adaptive)	16-ch BNC port (HDCVI/AHD/TVI/C VBS self-adaptive)

	Network Video Input	<ul style="list-style-type: none"> ● Support 0 IP channel by default. ● Max 6 IP channels connections (Add 2 IP channels and 4-channel analog/digital channel switch.). ● Connection bandwidth: 0Mbps-24Mbp. 	<ul style="list-style-type: none"> ● Support 0 IP channel by default. ● Max 12 IP channels connections (Add 4 IP channels and 8-channel analog/digital channel switch.). ● Connection bandwidth: 0Mbps-48Mbps. 	<ul style="list-style-type: none"> ● Support 0 IP channel by default. ● Max 24 IP channels connections (Add 8 IP channels and 16-channel analog/digital channel switch.). ● Connection bandwidth: 0Mbps-96Mbps.
	Video Output	1-ch VGA output, 1-ch HDMI output, HDMI/VGA video output at the same time.		
	Loop Output	N/A		
	Matrix Output	Support (VGA/HDMI optional)		
Audio Port	External Audio Input	4-channel RCA port	8-channel RCA port	16-channel RCA port
	Coaxial Audio Input	4-channel BNC port	8-channel BNC port	16-channel BNC port
	Audio Output	1-channel RCA port		
	Bidirectional Talk Input	Reuse audio input and output port of the first channel.		
Record	Record Mode	Alarm record, motion detection record, regular record, manual record, schedule record.		
	Playback Mode	Instant playback, normal playback, event playback, mark playback, intelligent playback.		
	Record Playback	Max 4-ch playback	Max 8-ch playback	Max 16-ch playback
	Backup Mode	HDD, burner, flash disk, network backup.		
Alarm	Alarm Input	8-channel		16-channel
	Alarm Output	3-channel		
HDD	HDD Port	1 SATA port		
	Space/HDD	8T		
Communication Port	Network	1 RJ45 port, 1000Mbps Ethernet port		
	Communication	1 RS485 port		
	USB	2 USB ports (One USB2.0 port at the front panel and one USB3.0 port at the rear panel.)		

Other	Power	DC12V		
	Power Consumption (No HDD)	≤10W		≤15W
	Working Temperature	-10°C ~ +55°C		
	Working Humidity	10%~90%		
	Dimension	Mini 1U case, 325mm*245mm*45mm (W*D*H)		
	Weight (No HDD)	≤1.1KG	≤1.25KG	≤1.45KG
	Installation Mode	Desk installation		

1.3.84 XVR7204A-4KL/XVR7208A-4KL/XVR7216A-4KL Series

Model	Parameters	XVR7204A-4KL	XVR7208A-4KL	XVR7216A-4KL
System	Main Processor	High-performance industrial embedded micro controller		
	OS	Embedded LINUX		
Video	Video Encode Standard	H.264		
	Encode Resolution	3840*2160@7fps/2592*1944@12fps/2560*1440@15fps/2048*1536@15fps/1080P/720P/960H/D1/CIF/QCIF		
	Video Frame Rate	PAL:1~25f/s;NTSC:1~30f/s		
	Video Bit Rate	32Kbps~8192Kbps		
	Bit Stream Type	Video stream/composite stream		
	Dual-Stream	Support. (Sub-stream max supports 960H encode.)		
Audio	Encode Standard	G.711A, G.711U, PCM, AAC (AAC for the first channel only)		
	Audio Sampling Rate	8KHz, 16Bit		
	Audio Bit Rate	64Kbps		
Video Port	Analog Video Input	4-ch BNC port (HDCVI/AHD/TVI/C VBS self-adaptive)	8-ch BNC port (HDCVI/AHD/TVI/C VBS self-adaptive)	16-ch BNC port (HDCVI/AHD/TVI/C VBS self-adaptive)

	Network Video Input	<ul style="list-style-type: none"> ● Support 0 IP channel by default. ● Max 6 IP channels connections (Add 2 IP channels and 4-channel analog/digital channel switch.). ● Connection bandwidth: 0Mbps-24Mbp. 	<ul style="list-style-type: none"> ● Support 0 IP channel by default. ● Max 12 IP channels connections (Add 4 IP channels and 8-channel analog/digital channel switch.). ● Connection bandwidth: 0Mbps-48Mbps. 	<ul style="list-style-type: none"> ● Support 0 IP channel by default. ● Max 24 IP channels connections (Add 8 IP channels and 16-channel analog/digital channel switch.). ● Connection bandwidth: 0Mbps-96Mbps.
	Video Output	1-ch VGA output, 1-ch HDMI output, HDMI/VGA video output at the same time.		
	Loop Output	N/A		
	Matrix Output	Support (VGA/HDMI optional)		
Audio Port	External Audio Input	4-channel RCA port		
	Coaxial Audio Input	4-channel BNC port	8-channel BNC port	16-channel BNC port
	Audio Output	1-channel RCA port		
	Bidirectional Talk Input	Reuse audio input and output port of the first channel.		
Record	Record Mode	Alarm record, motion detection record, regular record, manual record, schedule record.		
	Playback Mode	Instant playback, normal playback, event playback, mark playback, intelligent playback.		
	Record Playback	Max 4-ch playback	Max 8-ch playback	Max 16-ch playback
	Backup Mode	HDD, burner, flash disk, network backup.		
Alarm	Alarm Input	8-channel		16-channel
	Alarm Output	3-channel		
HDD	HDD Port	2 SATA ports		
	Space/HDD	8T		
Communication Port	Network	1 RJ45 port, 1000Mbps Ethernet port		
	Communication	1 RS485 port		
	USB	2 USB ports (One USB2.0 port at the front panel and one USB3.0 port at the rear panel.)		

Other	Power	DC12V	
	Power Consumption (No HDD)	≤10W	≤15W
	Working Temperature	-10℃~+55℃	
	Working Humidity	10%~90%	
	Dimension	1U case, 375mm*280mm*50mm (W*D*H)	
	Weight (No HDD)	≤1.65KG	≤1.80KG
	Installation Mode	Desk installation	

1.3.85 XVR7208A-4K Series

Model	Parameters	XVR7208A-4K
System	Main Processor	High-performance industrial embedded micro controller
	OS	Embedded LINUX
Video	Video Encode Standard	H.264
	Encode Resolution	3840*2160@15fps/2592*1944@15fps/2560*1440/2048*1536/1080P/720P/960H/D1/CIF/QCIF
	Video Frame Rate	PAL:1~25f/s;NTSC:1~30f/s
	Video Bit Rate	32Kbps~8192Kbps
	Bit Stream Type	Video stream/composite stream
	Dual-Stream	Support. (Sub-stream max supports 960H encode.)
Audio	Encode Standard	G.711A, G.711U, PCM, AAC (AAC for the first channel only)
	Audio Sampling Rate	8KHz, 16Bit
	Audio Bit Rate	64Kbps
Video Port	Analog Video Input	8-ch BNC port (HDCVI/AHD/TVI/CVBS self-adaptive)
	Network Video Input	<ul style="list-style-type: none"> ● Support 0 IP channel by default. ● Max 12 IP channels connections (Add 4 IP channels and 8-channel analog/digital channel switch.). ● Connection bandwidth: 0Mbps-48Mbps.
	Video Output	1-ch VGA output, 1-ch HDMI output, HDMI/VGA video output at the same time.

	Loop Output	N/A
	Matrix Output	Support (VGA/HDMI optional)
Audio Port	External Audio Input	4-channel RCA port
	Coaxial Audio Input	8-channel BNC port
	Audio Output	1-channel RCA port
	Bidirectional Talk Input	Reuse audio input and output port of the first channel.
Record	Record Mode	Alarm record, motion detection record, regular record, manual record, schedule record.
	Playback Mode	Instant playback, normal playback, event playback, mark playback, intelligent playback.
	Record Playback	Max 8-ch playback
	Backup Mode	HDD, burner, flash disk, network backup.
Alarm	Alarm Input	16-channel
	Alarm Output	3-channel
HDD	HDD Port	2 SATA ports
	Space/HDD	8T
Communication Port	Network	1 RJ45 port, 1000Mbps Ethernet port
	Communication	1 RS485 port
	USB	2 USB ports (One USB2.0 port at the front panel and one USB3.0 port at the rear panel.)
Other	Power	DC12V
	Power Consumption (No HDD)	≤15W
	Working Temperature	-10℃~+55℃
	Working Humidity	10%~90%
	Dimension	1U case, 375mm*280mm*50mm (W*D*H)
	Weight (No HDD)	≤1.80KG
	Installation Mode	Desk installation

1.3.86 XVR410XC-S2 Series

	Parameters	XVR4104C-S2	XVR4108C-S2
System	Main Processor	Industrial embedded micro controller	

	Parameters	XVR4104C-S2	XVR4108C-S2
	OS	Embedded LINUX	
Video Parameters	Video Encode Standard	H.264	
	Encode Resolution	1080N/720P/960H/D1/HD1/2CIF/CIF/	1080N@12fps/720P@15fps/960H/D1/HD1/2CIF/CIF/
	Video Frame Rate	PAL:1~25f/s; NTSC:1~30f/s	
	Video Bit Rate	32Kbps-4096Kbps	
	Bit Stream Type	Video stream/composite stream	
	Dual-Stream	Support	
Audio Parameters	Encode Standard	G.711A/G.711U/PCM/AAC (AAC for the first channel only)	
	Audio Sampling Rate	8KHz,16Bit	
	Audio Bit Rate	64Kbps	
Video Port	Analog Video Input	4-ch BNC port(CVBS/CVI/AHD/ other analog HD video self-adaptive)	8-ch BNC port(CVBS/CVI/AHD/other analog HD video self-adaptive)
	Network Video Input	<ul style="list-style-type: none"> ● There is no IP channel by default. Max add 1 IP channel connection ● Analog/digital channel switch. Max 5 IP channel connections ● Connection bandwidth:0Mbps-20Mbps 	<ul style="list-style-type: none"> ● There is no IP channel by default.Max add 2 IP channel connections ● Analog/digital channel switch. Max 10 IP channel connections ● Connection bandwidth:0Mbps-40Mbps
	Video Output	1-channel VGA output, 1-channel HDMI output (of the same video source), HDMI/ VGA video output at the same time.	
	Loop Output	N/A	
	Matrix Output	N/A	
Audio Port	Audio Input	1-channel RCA port.	
	Coaxial Audio Input	4-channel	8-channel
	Audio Output	1-channel RCA port.	
	Bidirectional Talk Input	Reuse the audio input/output port of the 1 st channel.	
Record	Record Mode	Schedule record/manual record/MD record/Alarm record	
	Playback Mode	Instant playback, normal playback, event playback, mark playback, smart playback	
	Playback Channel	4-channel	8-channel
	Backup Mode	HDD, burner, USB device, network backup	

	Parameters	XVR4104C-S2	XVR4108C-S2
Alarm	Alarm Input	N/A	
	Alarm Output	N/A	
HDD	HDD Port	1 SATA port, does not support eSATA port	
	One HDD Space	8T	
Communication Port	Network	1 RJ45 port, 100Mbps Ethernet port	
	RS485 Communication	N/A	
	USB	2 USB2.0 ports(at the rear panel)	
Others	Power	DC12V	
	Power Consumption (No HDD)	≤7W	≤8W
	Working Temperature	-10℃~+55℃	
	Working Humidity	10%~90%	
	Dimensions	SMART 1U case, 270mm (W) x205mm (D) x41mm (H)	
	Weight (No HDD)	≤0.5KG	≤0.55KG
	Installation Mode	Desk	

1.3.87 XVR510XC-S2 Series

	Parameters	XVR5104C-S2	XVR5108C-S2
System	Main Processor	Industrial embedded micro controller	
	OS	Embedded LINUX	
Video Parameters	Video Encode Standard	H.264	
	Encode Resolution	4M Lite/1080P@15fps/1080N/720P/960H/D1/HD1/2CIF/CIF	
	Video Frame Rate	PAL:1~25f/s; NTSC:1~30f/s	
	Video Bit Rate	32Kbps-6144Kbps	
	Bit Stream Type	Video stream/composite stream	
	Dual-Stream	Support	
Audio Parameters	Encode Standard	G.711A/G.711U/PCM/AAC (AAC for the first channel only)	
	Audio Sampling Rate	8KHz, 16Bit	
	Audio Bit Rate	64Kbps	
Video Port	Analog Video Input	4-ch BNC port(CVBS/CVI/AHD /other analog HD video self-adaptive)	8-ch BNC port(CVBS/CVI/AHD/other analog HD video self-adaptive)
	Network Video Input	<ul style="list-style-type: none"> There is no IP channel by default. Max add 2 IP channel connections Analog/digital channel switch. Max 6 IP channel connections 	<ul style="list-style-type: none"> There is no IP channel by default. Max add 4 IP channel connections Analog/digital channel switch. Max 12 IP channel connections

	Parameters	XVR5104C-S2	XVR5108C-S2
		<ul style="list-style-type: none"> ● Connection bandwidth:0Mbps-24Mbps 	<ul style="list-style-type: none"> ● Connection bandwidth:0Mbps-48Mbps
	Video Output	1-channel VGA output, 1-channel HDMI output (of the same video source), HDMI/ VGA video output at the same time.	
	Loop Output	N/A	
	Matrix Output	N/A	
Audio Port	Audio Input	1-channel RCA port.	
	Coaxial Audio Input	4-channel	8-channel
	Audio Output	1-channel RCA port.	
	Bidirectional Talk Input	Reuse the audio input/output port of the 1st channel.	
Record	Record Mode	Schedule record/manual record/MD record/Alarm record	
	Playback Mode	Instant playback, normal playback, event playback, mark playback, smart playback	
	Playback Channel	4-channel	8-channel
	Backup Mode	HDD, burner, USB device, network backup	
Alarm	Alarm Input	N/A	
	Alarm Output	N/A	
HDD	HDD Port	1 SATA port,does not support eSATA port	
	One HDD Space	8T	
Communication Port	Network	1 RJ45 port, 100Mbps Ethernet port	
	RS485 Communication	N/A	
	USB	2 USB2.0 ports(at the rear panel)	
Others	Power	DC12V	
	Power Consumption (No HDD)	≤7W	≤8W
	Working Temperature	-10℃~+55℃	
	Working Humidity	10%~90%	
	Dimensions	SMART 1U case, 270mm (W) x205mm (D) x41mm (H)	
	Weight (No HDD)	≤0.5KG	≤0.55KG

1.3.88 XVR41XXHS-S2 Series

	Parameters	XVR4104HS-S2	XVR4108HS-S2	XVR4116HS-S2
System	Main Processor	Industrial embedded micro controller		
	OS	Embedded LINUX		
Video	Video Encode	H.264		

	Parameters	XVR4104HS-S2	XVR4108HS-S2	XVR4116HS-S2
Parameters	Standard			
	Encode Resolution	1080N/720P/960H/D1 /HD1/2CIF/CIF/	1080N@12fps/720P@15fps/960H/D1/HD1 /2CIF/CIF/	
	Video Frame Rate	PAL:1~25f/s; NTSC:1~30f/s		
	Video Bit Rate	32Kbps-4096Kbps		
	Bit Stream Type	Video stream/composite stream		
	Dual-Stream	Support		
Audio Parameters	Encode Standard	G.711A/G.711U/PCM/AAC (AAC for the first channel only)		
	Audio Sampling Rate	8KHz,16Bit		
	Audio Bit Rate	64Kbps		
Video Port	Analog Video Input	4-ch BNC port (CVBS/CVI/AHD /other analog HD video self-adaptive)	8-ch BNC port(CVBS/CVI/AHD /other analog HD video self-adaptive)	16-ch BNC port(CVBS/CVI/A HD /other analog HD video self-adaptive)
	Network Video Input	<ul style="list-style-type: none"> There is no IP channel by default. Max add 1 IP channel connection Analog /digital channel switch. Max 5 IP channel connections Connection bandwidth:0Mbps-20Mbps 	<ul style="list-style-type: none"> There is no IP channel by default. Max add 2 IP channel connections. Analog /digital channel switch. Max 10 IP channel connections Connection bandwidth:0Mbps-40Mbps 	<ul style="list-style-type: none"> There is no IP channel by default. Max add 2 IP channel connections Analog /digital channel switch. Max 18 IP channel connections Connection bandwidth:0 Mbps-56Mbps
	Video Output	1-channel VGA output, 1-channel HDMI output (of the same video source), HDMI/ VGA video output at the same time.		
	Loop Output	N/A		
	Matrix Output	N/A		
	Audio Port	Audio Input	1-channel RCA port.	
Coaxial Audio Input		4-channel	8-channel	16-channel

	Parameters	XVR4104HS-S2	XVR4108HS-S2	XVR4116HS-S2
	Audio Output	1-channel RCA port.		
	Bidirectional Talk Input	Reuse the audio input/output port.		
Record	Record Mode	Schedule record/manual record/MD record/Alarm record		
	Playback Mode	Instant playback, normal playback, event playback, mark playback, smart playback		
	Playback Channel	4-channel	8-channel	16-channel
	Backup Mode	HDD, burner, USB device, network backup		
Alarm	Alarm Input	N/A		
	Alarm Output	N/A		
HDD	HDD Port	1 SATA port, does not support eSATA port		
	One HDD Space	8T		
Communication Port	Network	1 RJ45 port, 100Mbps Ethernet port		
	RS485 Communication	1 RS485 port		
	USB	2 USB2.0 ports(One at the front panel and one at the rear panel)		
Others	Power	DC12V		
	Power Consumption (No HDD)	≤7W	≤8W	≤10W
	Working Temperature	-10°C ~ +55°C		
	Working Humidity	10%~90%		
	Dimensions	Compact 1U case, 260mm (W) ×220mm (D) ×44mm (H)		
	Weight (No HDD)	≤0.85KG	≤0.95KG	≤1.05KG
	Installation Mode	Desk		

1.3.89 XVR51XXHS-S2 Series

	Parameters	XVR5104HS-S2	XVR5108HS-S2	XVR5116HS-S2
System	Main Processor	Industrial embedded micro controller		
	OS	Embedded LINUX		
Video Parameters	Video Encode Standard	H.264		
	Encode Resolution	4M Lite/1080P@15fps/1080N/720P/960H/D1/HD1/2CIF/CIF/		
	Video Frame Rate	PAL:1~25f/s; NTSC:1~30f/s		

	Parameters	XVR5104HS-S2	XVR5108HS-S2	XVR5116HS-S2
	Video Bit Rate	32Kbps-6144Kbps		
	Bit Stream Type	Video stream/composite stream		
	Dual-Stream	Support		
Audio Parameters	Encode Standard	G.711A/G.711U/PCM/AAC (AAC for the first channel only)		
	Audio Sampling Rate	8KHz,16Bit		
	Audio Bit Rate	64Kbps		
Video Port	Analog Video Input	4-ch BNC port (CVBS/CVI/AHD /other analog HD video self-adaptive)	8-ch BNC port(CVBS/CVI/AHD /other analog HD video self-adaptive)	16-ch BNC port(CVBS/CVI/AHD /other analog HD video self-adaptive)
	Network Video Input	<ul style="list-style-type: none"> There is no IP channel by default. Max add 2 IP channel connections Analog /digital channel switch. Max 6 IP channel connections. Connection bandwidth:0Mbps-24Mbps 	<ul style="list-style-type: none"> There is no IP channel by default. Max add 4 IP channel connection Analog /digital channel switch. Max 12 IP channel connections. Connection bandwidth:0Mbps-48Mbps 	<ul style="list-style-type: none"> There is no IP channel by default. Max add 8 IP channel connections Analog /digital channel switch. Max 24 IP channel connections Connection bandwidth:0 Mbps-96Mbps
	Video Output	1-channel VGA output, 1-channel HDMI output (of the same video source), HDMI/ VGA video output at the same time.		
	Loop Output	N/A		
	Matrix Output	N/A		VGA/HDMI optional
Audio Port	Audio Input	1-channel RCA port.		
	Coaxial Audio Input	4-channel	8-channel	16-channel
	Audio Output	1-channel RCA port.		
	Bidirectional Talk Input	Reuse the audio input/output port of the 1 st channel.		
Record	Record Mode	Schedule record/manual record/MD record/Alarm record		
	Playback Mode	Instant playback, normal playback, event playback, mark playback,		

	Parameters	XVR5104HS-S2	XVR5108HS-S2	XVR5116HS-S2
		smart playback		
	Playback Channel	4-channel	8-channel	16-channel
	Backup Mode	HDD, burner, USB device, network backup		
Alarm	Alarm Input	N/A		
	Alarm Output	N/A		
HDD	HDD Port	1 SATA port, does not support eSATA port		
	One HDD Space	8T		
Communication Port	Network	1 RJ45 port, 100Mbps Ethernet port		1 RJ45 port, 1000Mbps Ethernet port
	RS485 Communication	1 RS485 port		
	USB	2 USB2.0 ports(One at the front panel and one at the rear panel)		1 USB2.0 port and 1 USB3.0 port (One USB2.0 port at the front panel and one USB3.0 port at the rear panel)
Others	Power	DC12V		
	Power Consumption (No HDD)	≤7W	≤8W	≤10W
	Working Temperature	-10°C~+55°C		
	Working Humidity	10%~90%		
	Dimensions	Compact 1U case, 260mm (W) x220mm (D) x44mm (H)		
	Weight (No HDD)	≤0.85KG	≤0.95KG	≤1.05KG
	Installation Mode	Desk		

1.3.90 XVR51XXH-S2 Series

	Parameters	XVR5104H-S2	XVR5108H-S2	XVR5116H-S2
System	Main Processor	Industrial embedded micro controller		
	OS	Embedded LINUX		
Video Parameters	Video Encode Standard	H.264		
	Encode	4M Lite/1080P@15fps/1080N/720P/960H/D1/HD1/2CIF/CIF		

	Parameters	XVR5104H-S2	XVR5108H-S2	XVR5116H-S2	
	Resolution				
	Video Frame Rate	PAL:1~25f/s; NTSC:1~30f/s			
	Video Bit Rate	32Kbps-6144Kbps			
	Bit Stream Type	Video stream/composite stream			
	Dual-Stream	Support			
Audio Parameters	Encode Standard	G.711A/G.711U/PCM/AAC (AAC for the first channel only)			
	Audio Sampling Rate	8KHz,16Bit			
	Audio Bit Rate	64Kbps			
Video Port	Analog Video Input	4-ch BNC port (CVBS/CVI/AHD /other analog HD video self-adaptive)	8-ch BNC port(CVBS/CVI/AHD /other analog HD video self-adaptive)	16-ch BNC port(CVBS/CVI/AHD /other analog HD video self-adaptive)	
	Network Video Input	<ul style="list-style-type: none"> There is no IP channel by default. Max add 2 IP channel connections Analog /digital channel switch. Max 6 IP channel connections Connection bandwidth:0Mbps-24Mbps 	<ul style="list-style-type: none"> There is no IP channel by default. Max add 4 IP channel connections Analog /digital channel switch. Max 12 IP channel connections Connection bandwidth:0Mbps-48Mbps 	<ul style="list-style-type: none"> There is no IP channel by default. Max add 8 IP channel connections Analog /digital channel switch. Max 24 IP channel connections Connection bandwidth:0Mbps-96Mbps 	
	Video Output	1-channel VGA output, 1-channel HDMI output (of the same video source), HDMI/ VGA video output at the same time.			
	Loop Output	N/A			
	Matrix Output	N/A		VGA/HDMI optional	
	Audio Port	Audio Input	1-channel RCA port.		
		Coaxial Audio Input	4-channel	8-channel	16-channel
Audio Output		1-channel RCA port.			

	Parameters	XVR5104H-S2	XVR5108H-S2	XVR5116H-S2
	Bidirectional Talk Input	Support (Reuse the audio port of the 1st channel)		
Record	Record Mode	Schedule record/manual record/MD record/Alarm record		
	Playback Mode	Instant playback, normal playback, event playback, mark playback, smart playback		
	Playback Channel	4-channel	8-channel	16-channel
	Backup Mode	HDD, burner, USB device, network backup		
Alarm	Alarm Input	N/A		
	Alarm Output	N/A		
HDD	HDD Port	1 SATA port, does not support eSATA port		
	One HDD Space	8T		
Communication Port	Network	1 RJ45 port, 100Mbps Ethernet port	1 RJ45 port, 1000Mbps Ethernet port	
	RS485 Communication	1 RS485 port		
	USB	2 USB2.0 ports(One at the front panel and one at the rear panel)	1 USB2.0 port and 1 USB3.0 port (One USB2.0 port at the front panel and one USB3.0 port at the rear panel)	
Others	Power	DC12V		
	Power Consumption	≤7W	≤8W	≤10W
	Working Temperature	-10℃~+55℃		
	Working Humidity	10%~90%		
	Dimensions	Mini 1U case, 325mm (W) ×245mm (D) ×45mm (H)		
	Weight	≤1.1KG	≤1.25KG	≤1.45KG
	Installation Mode	Desk		

1.3.91 XVR51XXHE-S2 Series

	Parameters	XVR5104HE-S2	XVR5108HE-S2	XVR5116HE-S2
System	Main Processor	Industrial embedded micro controller		
	OS	Embedded LINUX		
Video	Video Encode	H.264		

	Parameters	XVR5104HE-S2	XVR5108HE-S2	XVR5116HE-S2
Parameters	Standard			
	Encode Resolution	4M Lite/1080P@15fps/1080N/720P/960H/D1/HD1/2CIF/CIF		
	Video Frame Rate	PAL:1~25f/s; NTSC:1~30f/s		
	Video Bit Rate	32Kbps-6144Kbps		
	Bit Stream Type	Video stream/composite stream		
	Dual-Stream	Support		
Audio Parameters	Encode Standard	G.711A/G.711U/PCM/AAC (AAC for the first channel only)		
	Audio Sampling Rate	8KHz,16Bit		
	Audio Bit Rate	64Kbps		
Video Port	Analog Video Input	4-ch BNC port (CVBS/CVI/AHD /other analog HD video self-adaptive)	8-ch BNC port(CVBS/CVI/AHD /other analog HD video self-adaptive)	16-ch BNC port(CVBS/CVI/A HD /other analog HD video self-adaptive)
	Network Video Input	<ul style="list-style-type: none"> ● There is no IP channel by default. Max add 2 IP channel connections ● Analog /digital channel switch. Max 6 IP channel connections ● Connection bandwidth:0Mbps-24Mbps 	<ul style="list-style-type: none"> ● There is no IP channel by default. Max add 4 IP channel connections ● Analog /digital channel switch. Max 12 IP channel connections ● Connection bandwidth:0Mbps-48Mbps 	<ul style="list-style-type: none"> ● There is no IP channel by default. Max add 8 IP channel connections ● Analog /digital channel switch. Max 24 IP channel connections ● Connection bandwidth:0 Mbps-96Mbps
	Video Output	1-channel VGA output, 1-channel HDMI output (of the same video source), HDMI/ VGA video output at the same time.		
	Loop Output	N/A		
	Matrix Output	N/A		VGA/HDMI optional

	Parameters	XVR5104HE-S2	XVR5108HE-S2	XVR5116HE-S2
Audio Port	Audio Input	4-channel RCA port.	8-channel RCA port.	16-channel RCA port.
	Coaxial Audio Input	4-channel	8-channel	16-channel
	Audio Output	1-channel RCA port.		
	Bidirectional Talk Input	Support (Reuse the audio port of the 1st channel)		
Record	Record Mode	Schedule record/manual record/MD record/Alarm record		
	Playback Mode	Instant playback, normal playback, event playback, mark playback, smart playback		
	Playback Channel	4-channel	8-channel	16-channel
	Backup Mode	HDD, burner, USB device, network backup		
Alarm	Alarm Input	8-channel input	8-channel input	16-channel input
	Alarm Output	3-channel output		
HDD	HDD Port	1 SATA port, does not support eSATA port		
	One HDD Space	8T		
Communication Port	Network	1 RJ45 port, 100Mbps Ethernet port		1 RJ45 port, 1000Mbps Ethernet port
	RS85 Communication	1 RS485 port		
	USB	2 USB2.0 ports (One at the front panel and one at the rear panel)		1 USB2.0 port and 1 USB3.0 port (One USB2.0 port at the front panel and one USB3.0 port at the rear panel)
Others	Power	DC12V		
	Power Consumption	≤7W	≤8W	≤10W
	Working Temperature	-10℃~+55℃		
	Working Humidity	10%~90%		
	Dimensions	Mini 1U case, 325mm (W) ×245mm (D) ×45mm (H)		
	Weight	≤1.1KG	≤1.25KG	≤1.45KG
	Installation Mode	Desk		

1.3.92 XVR42XXA-S2 Series

Model	Parameters	XVR4204A-S2	XVR4208A-S2	XVR4216A-S2
System	Main Processor	High-performance industrial embedded micro controller		
	OS	Embedded LINUX		
Video	Video Encode Standard	H.264		
	Encode Resolution	1080N/720P/960H/D1/HD1/2CIF/CIF/	1080N@12fps/720P@15fps/960H/D1/H	D1/2CIF/CIF/
	Video Frame Rate	PAL:1~25f/s; NTSC:1~30f/s		
	Video Bit Rate	32Kbps~4096Kbps		
	Bit Stream Type	Video stream/composite stream		
	Dual-Stream	Support		
Audio	Encode Standard	G.711A, G.711U, PCM, AAC (AAC for the first channel only)		
	Audio Sampling Rate	8KHz, 16Bit		
	Audio Bit Rate	64Kbps		
Video Port	Analog Video Input	4-ch BNC port (CVBS/CVI/AHD /other analog HD video self-adaptive)	8-ch BNC port(CVBS/CVI/AHD /other analog HD video self-adaptive)	16-ch BNC port(CVBS/CVI /AHD /other analog HD video self-adaptive)

Model	Parameters	XVR4204A-S2	XVR4208A-S2	XVR4216A-S2
	Network Video Input	<ul style="list-style-type: none"> ● There is no IP channel by default. Max add 1 IP channel connection ● Analog /digital channel switch. Max 5 IP channel connections ● Connection bandwidth:0Mbps-20Mbps 	<ul style="list-style-type: none"> ● There is no IP channel by default. Max add 2 IP channel connections ● Analog /digital channel switch. Max 10 IP channel connections ● Connection bandwidth:0Mbps-40Mbps 	<ul style="list-style-type: none"> ● There is no IP channel by default. Max add 2 IP channel connections ● Analog /digital channel switch. Max 18 IP channel connections ● Connection bandwidth :0Mbps-56 Mbps
	Video Output	1-ch VGA output, 1-ch HDMI output, HDMI/ VGA video output at the same time (VGA/HDMI of the same video source)		
	Loop Output	N/A		
	Matrix Output	N/A		
Audio Port	External Audio Input	4-ch,RCA port,		
	Coaxial Audio Input	4-channel	8-channel	16-channel
	Audio Output	1-ch RCA port		
	Bidirectional Talk Input	Support (Reuse the audio port of the 1 st channel)		
Record	Record Mode	Auto record, manual record, motion detect record, alarm record		
	Playback Mode	Instant playback, normal playback, event playback, mark playback, smart playback		
	Playback Channel	4-channel	8-channel	16-channel
	Backup Mode	HDD, burner, flash disk, network backup.		
Alarm	Alarm Input	8-ch alarm input	8-ch alarm input	16-ch alarm input

Model	Parameters	XVR4204A-S2	XVR4208A-S2	XVR4216A-S2
	Alarm Output	3-ch alarm output		
HDD	HDD Port	2 SATA ports. Does not support eSATA port.		
	Space/HDD	8T		
Communication Port	Network	1 RJ45 port, 100Mbps Ethernet port		
	RS485 Communication	1 RS485 port		
	USB	2 USB2.0 ports(One at the front panel and one at the rear panel)		
Other	Power	DC12V		
	Power Consumption (No HDD)	≤7W	≤8W	≤10W
	Working Temperature	-10℃~+55℃		
	Working Humidity	10%~90%		
	Dimension	1U case,375mm (W) x280mm (D) x50mm (H)		
	Weight (No HDD)	≤1.5KG	≤1.65KG	≤1.8KG
	Installation Mode	Desk installation		

1.3.93 XVR42XXAN-S2 Series

Model	Parameters	XVR4216AN-S2
System	Main Processor	High-performance industrial embedded micro controller
	OS	Embedded LINUX
Video	Video Encode Standard	H.264
	Encode Resolution	1080N@12fps/720P@15fps/960H/D1/HD1/2CIF/CIF
	Video Frame Rate	PAL:1~25f/s; NTSC:1~30f/s
	Video Bit Rate	32Kbps~4096Kbps
	Bit Stream Type	Video stream/composite stream
	Dual-Stream	Support
Audio	Encode Standard	G.711A, G.711U, PCM, AAC (AAC for the first channel only)
	Audio Sampling Rate	8KHz,16Bit
	Audio Bit Rate	64Kbps

Video Port	Analog Video Input	16-ch BNC port(CVBS/CVI/AHD /other analog HD video self-adaptive)
	Network Video Input	<ul style="list-style-type: none"> ● There is no IP channel by default. Max add 2 IP channel connections ● Analog/digital channel switch. Max 18 IP channel connections ● Connection bandwidth:0Mbps-56Mbps
	Video Output	1-ch VGA output, 1-ch HDMI output, HDMI/ VGA video output at the same time (VGA/HDMI of the same video source)
	Loop Output	N/A
	Matrix Output	N/A
Audio Port	External Audio Input	1-ch,RCA port
	Coaxial Audio Input	16-channel
	Audio Output	1-ch RCA port
	Bidirectional Talk Input	Support (Reuse the audio port of the 1 st channel)
Record	Record Mode	Auto record, manual record, motion detect record, alarm record
	Playback Mode	Instant playback, normal playback, event playback, mark playback, smart playback
	Playback Channel	Max 16-ch playback
	Backup Mode	HDD, burner, flash disk, network backup.
Alarm	Alarm Input	N/A
	Alarm Output	N/A
HDD	HDD Port	2 SATA ports. Does not support eSATA port.
	Space/HDD	8T
Communication Port	Network	1 RJ45 port, 100Mbps Ethernet port
	RS485 Communication	1 RS485 port
	USB	2 USB2.0 ports(One at the front panel and one at the rear panel)
Other	Power	DC12V
	Power Consumption (No HDD)	≤10W
	Working Temperature	-10℃~+55℃
	Working Humidity	10%~90%
	Dimension	1U case,375mm (W) x280mm (D) x50mm (H)

	Weight (No HDD)	≤1.8KG
	Installation Mode	Desk installation

1.3.94 XVR52XXA-S2 Series

Model	Parameters	XVR5204A-S2	XVR5208A-S2	XVR5216A-S2
System	Main Processor	High-performance industrial embedded micro controller		
	OS	Embedded LINUX		
Video	Video Encode Standard	H.264		
	Encode Resolution	4M Lite/1080P@15fps/1080N/720P/960H/D1/HD1/2CIF/CIF		
	Video Frame Rate	PAL:1~25f/s; NTSC:1~30f/s		
	Video Bit Rate	32Kbps~6144Kbps		
	Bit Stream Type	Video stream/composite stream		
	Dual-Stream	Support		
Audio	Encode Standard	G.711A, G.711U, PCM, AAC (AAC for the first channel only)		
	Audio Sampling Rate	8KHz,16Bit		
	Audio Bit Rate	64Kbps		
Video Port	Analog Video Input	4-ch BNC port (CVBS/CVI/AHD /other analog HD video self-adaptive)	8-ch BNC port(CVBS/CVI/AHD /other analog HD video self-adaptive)	16-ch BNC port(CVBS/CVI /AHD /other analog HD video self-adaptive)

	Network Video Input	<ul style="list-style-type: none"> ● There is no IP channel by default. Max add 2 IP channel connections ● Analog /digital channel switch. Max 6 IP channel connections ● Connection bandwidth:0Mbps-24Mbps 	<ul style="list-style-type: none"> ● There is no IP channel by default. Max add 4 IP channel connections ● Analog /digital channel switch. Max 12 IP channel connections ● Connection bandwidth:0Mbps-48Mbps 	<ul style="list-style-type: none"> ● There is no IP channel by default. Max add 8 IP channel connections ● Analog /digital channel switch. Max 24 IP channel connections ● Connection bandwidth :0Mbps-96 Mbps
	Video Output	1-ch VGA output, 1-ch HDMI output, HDMI/ VGA video output at the same time (VGA/HDMI of the same video source)		
	Loop Output	N/A		
	Matrix Output	N/A		VGA/HDMI optional
Audio Port	External Audio Input	4-ch,RCA port,		
	Coaxial Audio Input	4-channel	8-channel	16-channel
	Audio Output	1-ch RCA port		
	Bidirectional Talk Input	Support (Reuse the audio port of the 1 st channel)		
Record	Record Mode	Auto record, manual record, motion detect record, alarm record		
	Playback Mode	Instant playback, normal playback, event playback, mark playback, smart playback		
	Playback Channel	4-channel	8-channel	16-channel
	Backup Mode	HDD, burner, flash disk, network backup.		
Alarm	Alarm Input	8-ch alarm input	8-ch alarm input	16-ch alarm input

	Alarm Output	3-ch alarm output		
HDD	HDD Port	2 SATA ports. Does not support eSATA port.		
	Space/HDD	6T		
Communication Port	Network	1 RJ45 port, 100Mbps Ethernet port		1 RJ45 port, 1000Mbps Ethernet port
	RS485 Communication	1 RS485 port		
	USB	2 USB2.0 ports(One at the front panel and one at the rear panel)		1 USB2.0 port and 1 USB3.0 port (One USB2.0 port at the front panel and one USB3.0 port at the rear panel)
Other	Power	DC12V		
	Power Consumption (No HDD)	≤7W	≤8W	≤10W
	Working Temperature	-10℃ ~ +55℃		
	Working Humidity	10%~90%		
	Dimension	1U case,375mm (W) x280mm (D) x50mm (H)		
	Weight (No HDD)	≤1.5KG	≤1.65KG	≤1.8KG
	Installation Mode	Desk installation		

Model	Parameters	XVR4232AN-S2
System	Main Processor	High-performance industrial embedded micro controller
	OS	Embedded LINUX
Video	Video Encode Standard	H.264
	Encode Resolution	4M Lite/1080P @15fps/1080N/720P/960H/D1/HD1/2CIF/CIF
	Video Frame Rate	PAL:1~25f/s; NTSC:1~30f/s
	Video Bit Rate	32Kbps~4096Kbps
	Bit Stream Type	Video stream/composite stream

	Dual-Stream	Support
Audio	Encode Standard	G.711A, G.711U, PCM, AAC (AAC for the first channel only)
	Audio Sampling Rate	8KHz,16Bit
	Audio Bit Rate	64Kbps
Video Port	Analog Video Input	32-ch BNC port(CVBS/CVI/AHD/other analog HD video self-adaptive)
	Network Video Input	<ul style="list-style-type: none"> ● There is no IP channel by default. ● Analog/digital channel switch. Max 16 IP channel connections ● Connection bandwidth:0Mbps-64Mbps
	Video Output	1-ch VGA output, 1-ch HDMI output, 1-ch TV output, TV/HDMI/ VGA video output at the same time (TV/VGA/HDMI of the same video source)
	Loop Output	N/A
	Matrix Output	VGA/HDMI optional
Audio Port	External Audio Input	1-ch,RCA port
	Coaxial Audio Input	32-channel
	Audio Output	1-ch RCA port
	Bidirectional Talk Input	Support (Reuse the audio port of the 1 st channel)
Record	Record Mode	Auto record, manual record, motion detect record, alarm record
	Playback Mode	Instant playback, normal playback, event playback, mark playback, smart playback(motion detect)
	Playback Channel	Max 16-ch playback
	Backup Mode	HDD, burner, flash disk, network backup.
Alarm	Alarm Input	N/A
	Alarm Output	N/A
HDD	HDD Port	2 SATA ports. Does not support eSATA port.
	Space/HDD	8T
Communication Port	Network	1 RJ45 port, 1000Mbps Ethernet port
	RS485 Communication	1 RS485 port
	USB	2 USB ports(One USB2.0 port at the front panel and one USB3.0 at the rear panel)
Other	Power	DC12V

	Power Consumption (No HDD)	≤20W
	Working Temperature	-10℃~+55℃
	Working Humidity	10%~90%
	Dimension	1U case,375mm (W) x280mm (D) x50mm (H)
	Net Weight (No HDD)	≤2KG
	Installation Mode	Desk installation

1.3.95 XVR52XXAN-S2 Series

Model	Parameters	XVR5204AN-S2	XVR5208AN-S2	XVR5216AN-S2
System	Main Processor	High-performance industrial embedded micro controller		
	OS	Embedded LINUX		
Video	Video Encode Standard	H.264		
	Encode Resolution	4M Lite/1080P@15fps/1080N/720P/960H/D1/HD1/2CIF/CIF		
	Video Frame Rate	PAL:1~25f/s; NTSC:1~30f/s		
	Video Bit Rate	32Kbps~6144Kbps		
	Bit Stream Type	Video stream/composite stream		
	Dual-Stream	Support		
Audio	Encode Standard	G.711A, G.711U, PCM, AAC (AAC for the first channel only)		
	Audio Sampling Rate	8KHz,16Bit		
	Audio Bit Rate	64Kbps		
Video Port	Analog Video Input	4-ch BNC port (CVBS/CVI/AHD /other analog HD video self-adaptive)	8-ch BNC port(CVBS/CVI/AHD /other analog HD video self-adaptive)	16-ch BNC port(CVBS/CVI/AHD /other analog HD video self-adaptive)

	Network Video Input	<ul style="list-style-type: none"> There is no IP channel by default. Max add 2 IP channel connections Analog /digital channel switch. Max 6 IP channel connections Connection bandwidth:0Mbps-24Mbps 	<ul style="list-style-type: none"> There is no IP channel by default. Max add 4 IP channel connections Analog /digital channel switch. Max 12 IP channel connections Connection bandwidth:0Mbps-48Mbps 	<ul style="list-style-type: none"> There is no IP channel by default. Max add 8 IP channel connections Analog /digital channel switch. Max 24 IP channel connections Connection bandwidth:0Mbps-96Mbps
	Video Output	1-ch VGA output, 1-ch HDMI output, HDMI/ VGA video output at the same time (VGA/HDMI of the same video source)		
	Loop Output	N/A		
	Matrix Output	N/A		VGA/HDMI optional
Audio Port	External Audio Input	1-ch,RCA port		
	Coaxial Audio Input	4-channel	8-channel	16-channel
	Audio Output	1-ch RCA port		
	Bidirectional Talk Input	Support (Reuse the audio port of the 1 st channel)		
Record	Record Mode	Auto record, manual record, motion detect record, alarm record		
	Playback Mode	Instant playback, normal playback, event playback, mark playback, smart playback		
	Playback Channel	4-channel	8-channel	16-channel
	Backup Mode	HDD, burner, flash disk, network backup.		
Alarm	Alarm Input	N/A		
	Alarm Output	N/A		
HDD	HDD Port	2 SATA ports. Does not support eSATA port.		
	Space/HDD	8T		
Communication Port	Network	1 RJ45 port, 100Mbps Ethernet port		1 RJ45 port, 1000Mbps Ethernet port
	RS485 Communication	RS485 port		

	USB	2 USB2.0 ports(One at the front panel and one at the rear panel)	1 USB2.0 port and 1 USB3.0 port (One USB2.0 port at the front panel and one USB3.0 port at the rear panel)	
Other	Power	DC12V		
	Power Consumption (No HDD)	≤7W	≤8W	≤10W
	Working Temperature	-10℃~+55℃		
	Working Humidity	10%~90%		
	Dimension	1U case,375mm (W) x280mm (D) x50mm (H)		
	Weight (No HDD)	≤1.5KG	≤1.65KG	≤1.8KG
	Installation Mode	Desk installation		

Model	Parameters	XVR5232AN-S2
System	Main Processor	High-performance industrial embedded micro controller
	OS	Embedded LINUX
Video	Video Encode Standard	H.264
	Encode Resolution	4M Lite/1080P@15fps/1080N/720P/960H/D1/HD1/2CIF/CIF
	Video Frame Rate	PAL:1~25f/s; NTSC:1~30f/s
	Video Bit Rate	32Kbps~6144Kbps
	Bit Stream Type	Video stream/composite stream
	Dual-Stream	Support
Audio	Encode Standard	G.711A, G.711U, PCM, AAC (AAC for the first channel only)
	Audio Sampling Rate	8KHz,16Bit
	Audio Bit Rate	64Kbps
Video Port	Analog Video Input	32-ch BNC port (CVBS/CVI/AHD/other analog HD video self-adaptive)
	Network Video Input	<ul style="list-style-type: none"> ● There is no IP channel by default. ● Analog/digital channel switch. Max 32 IP channel connections. ● Connection bandwidth:0Mbps-128Mbps

	Video Output	1-ch VGA output, 1-ch HDMI output, 1-ch TV output, TV/HDMI/ VGA video output at the same time (TV/VGA/HDMI of the same video source)
	Loop Output	N/A
	Matrix Output	VGA/HDMI optional
Audio Port	External Audio Input	1-ch,RCA port
	Coaxial Audio Input	32-channel
	Audio Output	1-ch RCA port
	Bidirectional Talk Input	Support (Reuse the audio port of the 1 st channel)
Record	Record Mode	Auto record, manual record, motion detect record, alarm record
	Playback Mode	Instant playback, normal playback, event playback, mark playback, smart playback(human face,motion detect)
	Playback Channel	Max 16-ch playback
	Backup Mode	HDD, burner, flash disk, network backup.
Alarm	Alarm Input	N/A
	Alarm Output	N/A
HDD	HDD Port	2 SATA ports. Does not support eSATA port.
	Space/HDD	8T
Communication Port	Network	1 RJ45 port, 1000Mbps Ethernet port
	RS485 Communication	1 RS485 port
	USB	2 USB port (One USB2.0 port at the front panel and one USB3.0 port at the rear panel)
Other	Power	DC12V
	Power Consumption (No HDD)	≤27W
	Working Temperature	-10℃ ~ +55℃
	Working Humidity	10%~90%
	Dimension	1U case,375mm (W) x280mm (D) x50mm (H)
	Net Weight (No HDD)	≤2KG
	Installation Mode	Desk installation

1.3.96 XVR5108H-4KL-8P Series

Model	Parameters	XVR5108H-4KL-8P
System	Main Processor	High-performance industrial embedded micro controller
	OS	Embedded LINUX
Video	Video Encode Standard	H.264+/H.264
	Encode Resolution	3840*2160@7fps/2880*1920@10fps/2592*1944@12fps/2560*1440@15fps/2048*1536@15fps/1080P/720P/960H/D1/CIF/QCIF
	Video Frame Rate	PAL:1~25f/s;NTSC:1~30f/s
	Video Bit Rate	32Kbps~8192Kbps
	Bit Stream Type	Video stream/composite stream
	Dual-Stream	Support. (Sub-stream max supports 960H encode.)
Audio	Encode Standard	G.711A, G.711U, PCM, AAC (AAC for the first channel only)
	Audio Sampling Rate	8KHz, 16Bit
	Audio Bit Rate	64Kbps
Video Port/PoC Port	Analog Video Input	8-ch BNC port (HDCVI/AHD/TVI/CVBS self-adaptive)
	Network Video Input	<ul style="list-style-type: none"> ● Support 0 IP channel by default. ● Max 12 IP channels connections (Add 4 IP channels and 8-channel analog/digital channel switch.). ● Connection bandwidth: 0Mbps-48Mbps.
	Video Output	1-ch VGA output, 1-ch HDMI output, HDMI/VGA video output at the same time.
	PoC	8-channel. Support power over coax (PoC) function. It can provide power to the connected camera. Each channel max supports 12W. Each 4 channels' (1-4 or 5-8) total power consumption shall not be more than 24W.
	Loop Output	N/A
	Matrix Output	Support (VGA/HDMI optional)
Audio Port	External Audio Input	1-channel RCA port
	Coaxial Audio Input	8-channel BNC port
	Audio Output	1-channel RCA port
	Bidirectional Talk Input	Reuse audio input and output port of the first channel.

Record	Record Mode	Alarm record, motion detection record, regular record, manual record, schedule record.
	Playback Mode	Instant playback, normal playback, event playback, mark playback, intelligent playback.
	Record Playback	Max 8-ch playback
	Backup Mode	HDD, burner, flash disk, network backup.
Alarm	Alarm Input	N/A
	Alarm Output	N/A
HDD	HDD Port	1 SATA port
	Space/HDD	6T
Communication Port	Network	1 RJ45 port, 1000Mbps Ethernet port
	Communication	1 RS485 port
	USB	2 USB ports (One USB2.0 port at the front panel and one USB3.0 port at the rear panel.)
Other	Power	DC 48V 1.5A
	Power Consumption (No HDD)	≤10W
	Working Temperature	-10℃~+55℃
	Working Humidity	10%~90%
	Dimension	Mini 1U case, 325mm*245mm*45mm (W*D*H)
	Weight (No HDD)	≤1.35KG
	Installation Mode	Desk installation

1.3.97 XVR5208AN-4KL-8P/XVR5216AN-4KL-16P Series

Model	Parameters	XVR5208AN-4KL-8P	XVR5216AN-4KL-16P
System	Main Processor	High-performance industrial embedded micro controller	
	OS	Embedded LINUX	
Video	Video Encode Standard	H.264+/H.264	
	Encode Resolution	3840*2160@7fps/2880*1920@10fps/2592*1944@12fps/2560*1440@15fps/2048*1536@15fps/1080P/720P/960H/D1/CIF/QCIF	
	Video Frame Rate	PAL:1~25f/s;NTSC:1~30f/s	
	Video Bit Rate	32Kbps~8192Kbps	

	Bit Stream Type	Video stream/composite stream		
	Dual-Stream	Support. (Sub-stream max supports 960H encode.)		
Audio	Encode Standard	G.711A, G.711U, PCM, AAC (AAC for the first channel only)		
	Audio Sampling Rate	8KHz, 16Bit		
	Audio Bit Rate	64Kbps		
Video Port/PoC Port	Analog Video Input	8-ch BNC port (HDCVI/AHD/TVI/CVBS self-adaptive)	16-ch BNC port (HDCVI/AHD/TVI/CVBS self-adaptive)	
	Network Video Input	<ul style="list-style-type: none"> ● Support 0 IP channel by default. ● Max 12 IP channels connections (Add 4 IP channels and 8-channel analog/digital channel switch.). ● Connection bandwidth: 0Mbps-48Mbps. 	<ul style="list-style-type: none"> ● Support 0 IP channel by default. ● Max 24 IP channels connections (Add 8 IP channels and 16-channel analog/digital channel switch.). ● Connection bandwidth: 0Mbps-96Mbps. 	
	Video Output	1-ch VGA output, 1-ch HDMI output, HDMI/VGA video output at the same time.		
	PoC	8-channel.	16-channel.	
		Support power over coax (PoC) function. It can provide power to the connected camera. Each channel max supports 12W. Each 4 channels' (1-4, 5-8, 9-12 or 13-16) total power consumption shall not be more than 24W.		
	Loop Output	N/A		
	Matrix Output	Support (VGA/HDMI optional)		
Audio Port	External Audio Input	1-channel RCA port		
	Coaxial Audio Input	8-channel BNC port	16-channel BNC port	
	Audio Output	1-channel RCA port		
	Bidirectional Talk Input	Reuse audio input and output port of the first channel.		
Record	Record Mode	Alarm record, motion detection record, regular record, manual record, schedule record.		
	Playback Mode	Instant playback, normal playback, event playback, mark playback, intelligent playback.		

	Record Playback	Max 8-ch playback	Max 16-ch playback
	Backup Mode	HDD, burner, flash disk, network backup.	
Alarm	Alarm Input	N/A	
	Alarm Output	N/A	
HDD	HDD Port	2 SATA ports	
	Space/HDD	6T	
Communication Port	Network	1 RJ45 port, 1000Mbps Ethernet port	
	Communication	1 RS485 port	
	USB	2 USB ports (One USB2.0 port at the front panel and one USB3.0 port at the rear panel.)	
Other	Power	DC 48V 2A.	DC 48V 2.5A.
	Power Consumption (No HDD)	≤10W	≤18W
	Working Temperature	-10℃~+55℃	
	Working Humidity	10%~90%	
	Dimension	1U case, 375mm*280mm*50mm (W*D*H)	
	Weight (No HDD)	≤1.75KG	≤2.00KG
	Installation Mode	Desk installation	

1.3.98 XVR1A04/XVR1A08 Series

	Parameters	XVR1A04	XVR1A08
System	Main Processor	Industrial embedded micro controller	
	OS	Embedded LINUX	
Video Parameters	Video Encode Standard	H.264	
	Encode Resolution	1080N/720P/960H/D1/HD1/BCIF/CIF/QCIF	The first channel: 1080N/720P/960H/D1/CIF The rest channels: 1080N@12fps/720P@15fps/960H/D1/HD1/BCIF/CIF/QCIF
	Video Frame Rate	PAL:1~25f/s; NTSC:1~30f/s	
	Video Bit Rate	32Kbps-4096Kbps	
	Bit Stream Type	Video stream/composite stream	
	Dual-Stream	Support	

	Parameters	XVR1A04	XVR1A08
Audio Parameters	Encode Standard	G.711A/G.711U/PCM/AAC (AAC for the first channel only)	
	Audio Sampling Rate	8KHz,16Bit	
	Audio Bit Rate	64Kbps	
Video Port	Analog Video Input	4-ch BNC port(CVBS/CVI/AHD/ other analog HD video self-adaptive)	8-ch BNC port(CVBS/CVI/AHD/other analog HD video self-adaptive)
	Network Video Input	<ul style="list-style-type: none"> There is no IP channel by default. Max add 1 IP channel connection Analog/digital channel switch. Max 5 IP channel connections Connection bandwidth:0Mbps-20Mbps 	<ul style="list-style-type: none"> There is no IP channel by default.Max add 2 IP channel connections Analog/digital channel switch. Max 10 IP channel connections Connection bandwidth:0Mbps-40Mbps
	Video Output	1-channel VGA output, 1-channel HDMI output (of the same video source), HDMI/ VGA video output at the same time.	
	Loop Output	N/A	
	Matrix Output	N/A	
Audio Port	Audio Input	1-channel RCA port.	
	Coaxial Audio Input	4-channel	8-channel
	Audio Output	1-channel RCA port.	
	Bidirectional Talk Input	Reuse the audio input/output port of the 1 st channel.	
Record	Record Mode	Schedule record/manual record/MD record/Alarm record	
	Playback Mode	Instant playback, normal playback, event playback, mark playback, smart playback	
	Playback Channel	4-channel	8-channel
	Backup Mode	HDD, burner, USB device, network backup	
Alarm	Alarm Input	N/A	
	Alarm Output	N/A	
HDD	HDD Port	1 SATA port,does not support eSATA port	
	One HDD Space	6T	
Communication Port	Network	1 RJ45 port, 100Mbps Ethernet port	
	RS485 Communication	N/A	
	USB	2 USB2.0 ports(at the rear panel)	
Others	Power	DC12V	

	Parameters	XVR1A04	XVR1A08
	Power Consumption (No HDD)	≤5W	≤6W
	Working Temperature	-10°C~+45°C	
	Working Humidity	10%~90%	
	Dimensions	Cooper 1U case, 197mm (W) ×192.1mm (D) ×41.5mm (H)	
	Weight (No HDD)	≤0.55KG	
	Installation Mode	Desk	

2 Overview and Controls

This section provides information about front panel and rear panel. When you install this series DVR for the first time, please refer to this part first.

2.1 Front Panel

2.1.1 HCVR5104C/HCVR51XXC-V2/HCVR71XXC-V2/ HCVR4104/4108C-S2/ HCVR5104 5108C-S2/ HCVR7104C-S2/ HCVR2108C-S2/ HCVR410XC-S3/HCVR510XC-S3/7104C-S3/ XVR410XC/XVR510XC/7104C/XVR51XXC-4M/ XVR41XXC-S2/ XVR51XXC-S2 Series

The front panel is shown as below. See Figure 2-1.

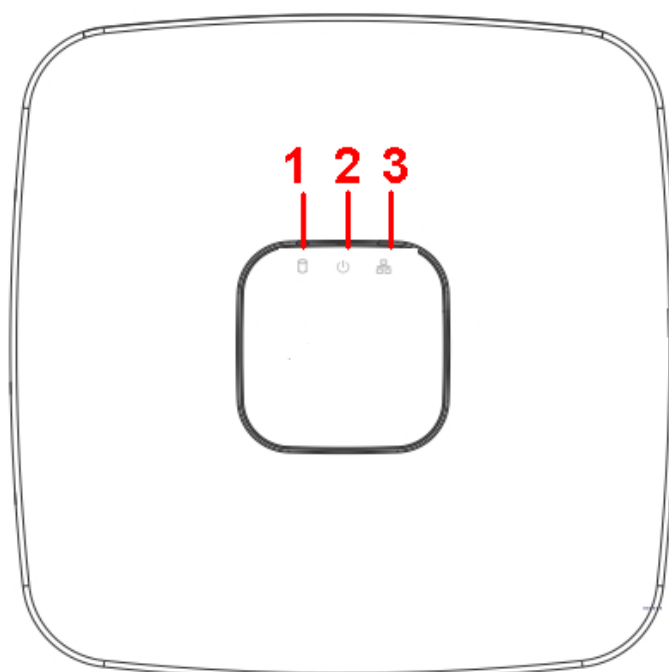

Figure 2-1

Please refer to the following sheet for front panel button information.

SN	Name	Function
1	HDD status indicator light	The red light becomes on when HDD is abnormal.
2	Power indicator light	The red light becomes on when the power connection is OK.
3	Network status indicator light	The red light becomes on when the network connection is abnormal.

2.1.2 HCVR51XXH/HCVR51XXHE/ HCVR51XXH-V2 / HCVR51XXHE-V2/HCVR71XXH-V2 / HCVR71XXHE-V2 Series

The front panel is shown as below. See Figure 2-2.

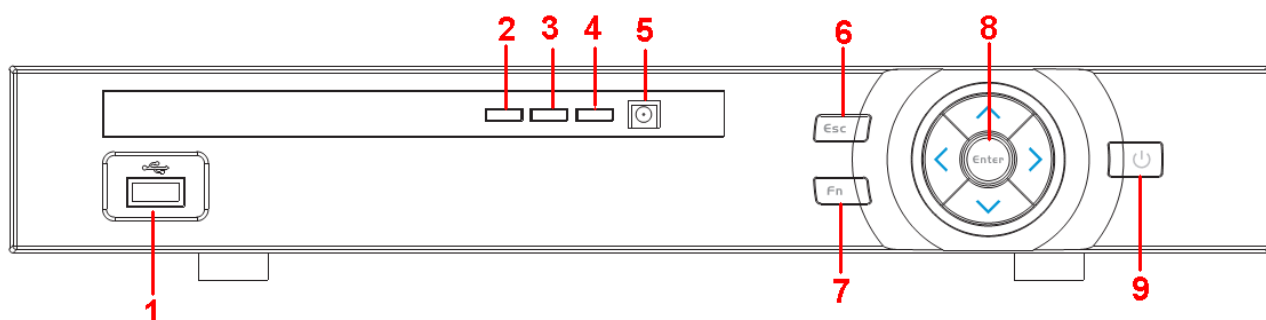

Figure 2-2

Please refer to the following sheet for front panel button information.

SN	Icon	Name	Function
1		USB port	To connect USB storage device, USB mouse and etc.
2	Alarm	Alarm indicator light	When an alarm occurs, the light becomes red to alert you.
3	NET	Network abnormal indicator light	Network error occurs or there is no network connection, the light becomes red to alert you.
3	HDD	HDD abnormal indicator light	HDD error occurs or HDD capacity is below specified threshold value, the light becomes red to alert you.
5	IR	IR Receiver	It is to receive the signal from the remote control.
6	ESC	ESC	Go to previous menu, or cancel current operation. When playback, click it to restore real-time monitor mode.
7	FN	Assist	One-window monitor mode, click this button to display assistant function: PTZ control and image color. Backspace function: in numeral control or text control, press it for 1.5seconds to delete the previous character before the cursor. In motion detection setup, working with Fn and direction keys to realize setup. In text mode, click it to switch between numeral, English character(small/capitalized) and etc. Realize other special functions.
8	Enter	ENTER	Confirm current operation Go to default button Go to menu
9		Power button	Power button, press this button for three seconds to boot up or shut down DVR.
		Up Down	Activate current control, modify setup, and then move up and down. Increase/decrease numeral. Assistant function such as PTZ menu.
		Left Right	Shift current activated control, When playback, click these buttons to control playback bar.

2.1.3 HCVR51XXHC/ HCVR51XXHC-V2/ HCVR71XXHC-V2 Series

The interface is shown as below. See Figure 2-3.

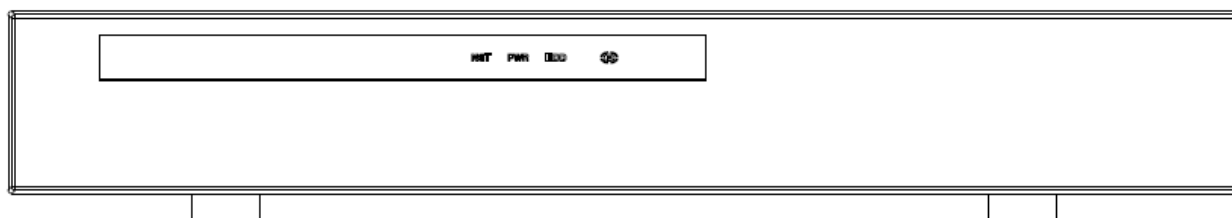

Figure 2-3

Please refer to the following sheet for front panel button information.

SN	Icon	Name	Function
1	NET	Network abnormal indicator light	Network error occurs or there is no network connection, the light becomes red to alert you.
2	PWR	Power indicator light	The red light becomes on when the power connection is OK.
3	HDD	HDD abnormal indicator light	HDD error occurs or HDD capacity is below specified threshold value, the light becomes red to alert you.

2.1.4 HCVR41XXHE-S2/ HCVR51XXH-S2/ HCVR51XXHE-S2/ HCVR710XH-S2/ HCVR710XE-S2/ HCVR41XXHE-S3/HCVR51XXH-S3/HCVR51XXHE-S3/HCVR71X XH-S3/HCVR71XXHE-S3 /HCVR41XXHS-S2/ HCVR21XXHS-S2/ HCVR21XXHS-S3/HCVR41XXHS-S3/51XXHS-S3/7104HS-S3/ XVR41XXHE/XVR51H/XVR51XXHE/XVR71XXH/XVR71XXHE /HCVR41XXHS-S2/ HCVR21XXHS-S2/ XVR21XXHS/XVR41XXHS/XVR51XXHS/XVR7104HS/HCVR71XX- 4M/HCVR710XH-4K/XVR51XXHS-4M/XVR51XXHS-4KL/XVR51X XH-4M/ XVR51XXH-4KL/ XVR71XXHE-4KL/XVR51XXH-S2/XVR51HE-S2/ XVR41XXHS-S2/ XVR51XXHS-S2/XVR5108H-4KL-8P Series

The front panel is shown as below. See Figure 2-4.

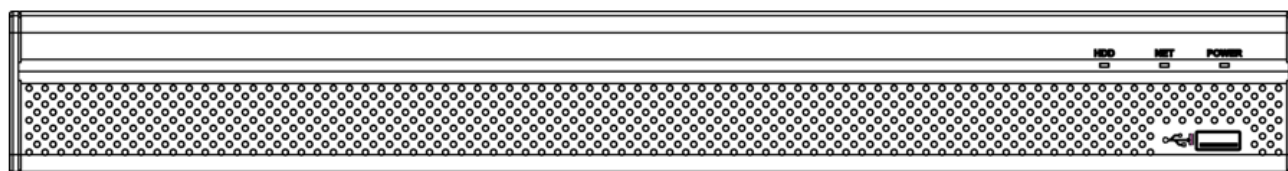



Figure 2-4

Please refer to the following sheet for front panel button information.

Icon	Name	Function
HDD	HDD status indicator light	The blue light is on when the HDD is malfunction.

Icon	Name	Function
NET	Network status indicator light	The blue light is on when the network connection is abnormal.
POWER	Power status indicator light	The blue light is on when the power connection is OK.
	USB2.0 port	Connect to peripheral USB 2.0 storage device, mouse, burner and etc.

2.1.5 HCVR52XXA-V2/ HCVR72XXA-V2 Series

The front panel is shown as below. See Figure 2-5.

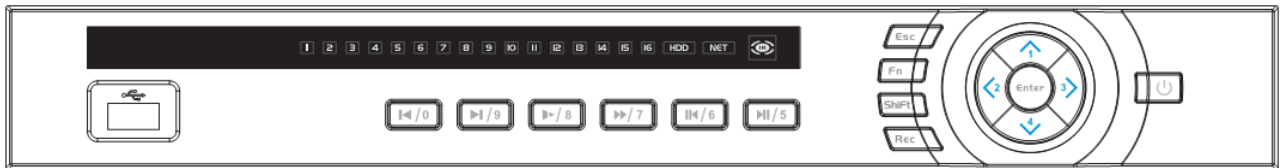











Figure 2-5

Please refer to the following sheet for front panel button information.

Name	Icon	Function
Power button		Power button, press this button for three seconds to boot up or shut down DVR.
Shift	Shift	In textbox, click this button to switch between numeral, English(Small/Capitalized),donation and etc.
Up/1Down/4		Activate current control, modify setup, and then move up and down.
		Increase/decrease numeral.
		Assistant function such as PTZ menu.
Left/2 Right/3		Shift current activated control,
		When playback, click these buttons to control playback bar. In text mode, input number 2(English character A/B/C) /3(English character D/E/F)
ESC	ESC	Go to previous menu, or cancel current operation.
		When playback, click it to restore real-time monitor mode.
Enter	ENTER	Confirm current operation
		Go to default button
		Go to menu

Record	REC	Manually stop/start recording, working with direction keys or numeral keys to select the recording channel.
Slow play/8		Multiple slow play speeds or normal playback. In text mode, input number 8 (English character T/U/V).
Assistant	Fn	One-window monitor mode, click this button to display assistant function: PTZ control and image color.
		Backspace function: in numeral control or text control, press it for 1.5seconds to delete the previous character before the cursor.
		In motion detection setup, working with Fn and direction keys to realize setup.
		In text mode, click it to switch between numeral, English character(small/capitalized) and etc.
		Realize other special functions.
Fast play/7		Various fast speeds and normal playback. In text mode, input number 7 (English character P/Q/R/S).
Play previous/0		In playback mode, playback the previous video In text mode, input number 0.
Reverse/Pause/6		In normal playback or pause mode, click this button to reverse playback In reverse playback, click this button to pause playback.
Play Next/9		In playback mode, playback the next video In menu setup, go to down ward of the dropdown list. In text mode, input number 9 (English character W/X/Y/Z)
Play/Pause /5		In normal playback click this button to pause playback In pause mode, click this button to resume playback. In text mode, input number 5(English character J/K/L).
USB port		To connect USB storage device, USB mouse.
Network abnormal indication light	Net	Network error occurs or there is no network connection, the light becomes red to alert you.
HDD abnormal indication light	HDD	HDD error occurs or HDD capacity is below specified threshold value, the light becomes red to alert you.

Record light	1-16	System is recording or not. It becomes on when system is recording.
IR Receiver	IR	It is to receive the signal from the remote control.

**2.1.6 HCVR42XXA-S2/ HCVR42XXAN-S2/ HCVR52XXA-S2/
 HCVR5216AN-S2/HCVR720XA-S2/
 HCVR42XXA-S3/HCVR42XXAN-S3/HCVR52XXA-S3/HCVR52XXAN-
 S3/HCVR72XXA-S3/HCVR7216AN-S3/XVR42XXA/XVR42XXAN/XVR
 52XXA/XVR52XXAN/XVR72XXA/XVR7216AN/HCVR
 72XXAN-4M/HCVR720XAN-4K/XVR52XXAN-4M/
 XVR52XXAN-4KL/XVR72XXA-4KL/XVR72XXA-4K/ XVR42XXA-S2/
 XVR42XXAN-S2/ XVR52XXA-S2/
 XVR52XXAN-S2/XVR5208AN-4KL-8P/XVR5216AN-4KL-16P Series**

The front panel is shown as below. See Figure 2-6.

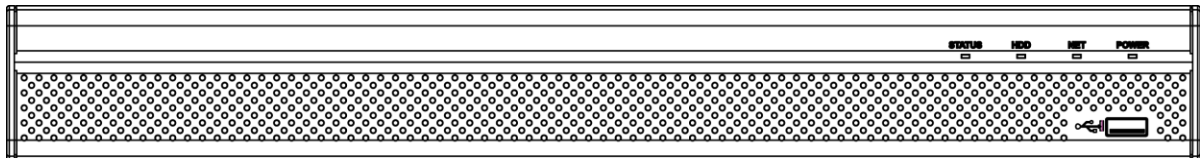



Figure 2-6

Please refer to the following sheet for front panel button information.

Icon	Name	Function
STATUS	Status indicator light	The blue light is on when the device is working properly.
HDD	HDD status indicator light	The blue light is on when the HDD is malfunction.
NET	Network status indicator light	The blue light is on when the network connection is abnormal.
POWER	Power status indicator light	The blue light is on when the power connection is OK.
	USB2.0 port	Connect to peripheral USB 2.0 storage device, mouse, burner and etc.

2.1.7 HCVR42XXL-S2/HCVR44XXL-S2/ XVR54XXL/ XVR74XXL Series

The front panel is shown as below. See Figure 2-7.

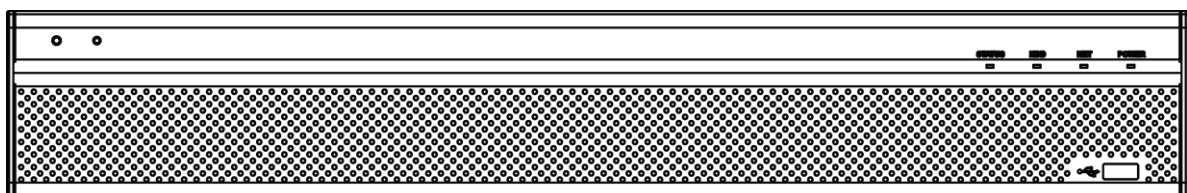



Figure 2-7

Please refer to the following sheet for front panel button information.

Icon	Name	Function
	STATUS	Status indicator light
	HDD	HDD status indicator light
	NET	Network status indicator light
	POWER	Power status indicator light
	USB2.0 port	Connect to peripheral USB 2.0 storage device, mouse, burner and etc.

2.1.8 HCVR52XXL-V2/ HCVR54XXL-V2 Series

The front panel is shown as in Figure 2-8.

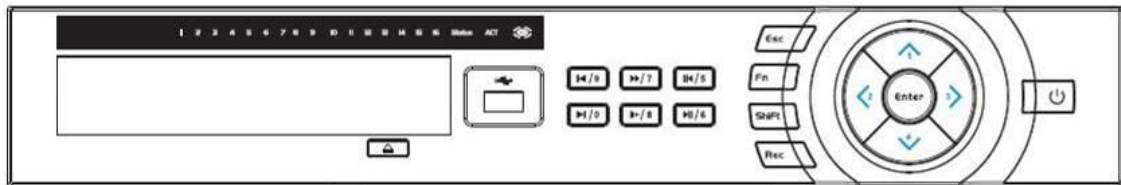









Figure 2-8

Please refer to the following sheet for front panel button information.

Name	Icon	Function
Power button		Power button, press this button for three seconds to boot up or shut down DVR.
Shift	Shift	In textbox, click this button to switch between numeral, English(Small/Capitalized),donation and etc.
Up/1 Down/4	▲、▼	Activate current control, modify setup, and then move up and down.
		Increase/decrease numeral.
		Assistant function such as PTZ menu.
		In text mode, input number 1/4 (English character G/H/I)
Left/2 Right/3	◀ ▶	Shift current activated control,
		When playback, click these buttons to control playback bar. In text mode, input number 2(English character A/B/C) /3(English character D/E/F)
ESC	ESC	Go to previous menu, or cancel current operation.

		When playback, click it to restore real-time monitor mode.
Enter	ENTER	Confirm current operation
		Go to default button
		Go to menu
Record	REC	Manually stop/start recording, working with direction keys or numeral keys to select the recording channel.
Slow play/8		Multiple slow play speeds or normal playback. In text mode, input number 8 (English character T/U/V).
Assistant	Fn	One-window monitor mode, click this button to display assistant function: PTZ control and image color.
		Backspace function: in numeral control or text control, press it for 1.5seconds to delete the previous character before the
		In motion detection setup, working with Fn and direction keys to realize setup.
		In text mode, click it to switch between numeral, English character(small/capitalized) and etc.
		Realize other special functions.
Fast play/7		Various fast speeds and normal playback. In text mode, input number 7 (English character P/Q/R/S).
Play previous/0		In playback mode, playback the previous video In text mode, input number 0.
Reverse/Pause/6		In normal playback or pause mode, click this button to reverse playback In reverse playback, click this button to pause playback.
Play Next/9		In playback mode, playback the next video In menu setup, go to down ward of the dropdown list. In text mode, input number 9 (English character W/X/Y/Z)
Play/Pause /5		In normal playback click this button to pause playback In pause mode, click this button to resume playback. In text mode, input number 5(English character J/K/L).
USB port		To connect USB storage device, USB mouse.
Network abnormal indication light	Net	Network error occurs or there is no network connection, the light becomes red to alert you.
HDD abnormal indication light	HDD	HDD error occurs or HDD capacity is below specified threshold value, the light becomes red to alert you.

Record light	1-16	System is recording or not. It becomes on when system is recording.
--------------	------	---------------------------------------------------------------------

2.1.9 HCVR58XXS-V2 Series

This series products' front panel is shown as below. See Figure 2-9.

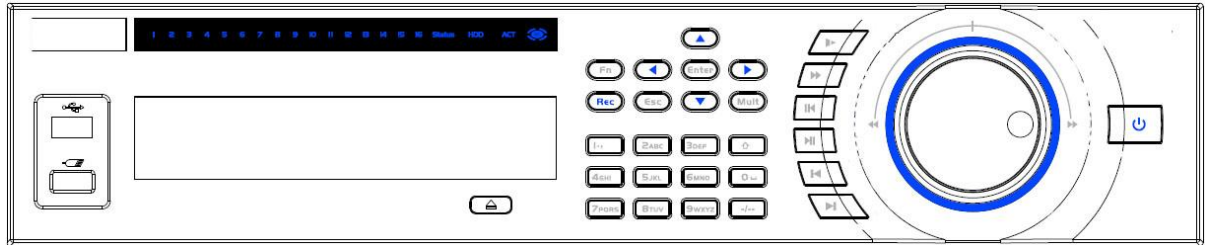



Figure 2-9

Please refer to the following sheet for front panel button information.

Name	Icon	Function
Power button	⏻	Power button, press this button for three seconds to boot up or shut down DVR.
Number button	0-9	Input Arabic number Switch channel
Input number more than 10	-/--	If you want to input a number more than 10, please click this button and then input.
Shift	⬆	In textbox, click this button to switch between numeral, English(Small/Capitalized),donation and etc.
		Enable or disable tour.
Fast play	⏩	Various fast speeds and normal playback.
Slow play	⏪	Multiple slow play speeds or normal playback.
Play/Pause	⏸	In normal playback click this button to pause playback In pause mode, click this button to resume playback.
Reverse/Pause	⏮	In normal playback or pause mode, click this button to reverse playback In reverse playback, click this button to pause playback.
Play previous	⏮	In playback mode, playback the previous video
Play Next	⏭	In playback mode, playback the next video In menu setup, go to down ward of the dropdown list.
Up/ Down	▲、▼	Activate current control, modify setup, and then move up and down.
		Increase/decrease numeral.

		Assistant function such as PTZ menu.
Left/ Right	◀ ▶	Shift current activated control, and then move left and right.
		When playback, click these buttons to control playback bar.
ESC	ESC	Go to previous menu, or cancel current operation.
		When playback, click it to restore real-time monitor mode.
Enter	ENTER	Confirm current operation
		Go to default button
		Go to menu
Assistant	Fn	One-window monitor mode, click this button to display assistant function: PTZ control and image color.
		Backspace function: in numeral control or text control, press it for 1.5 seconds to delete the previous character before the cursor.
		In motion detection setup, working with Fn and direction keys to realize setup.
		In text mode, click it to switch between numeral, English character (small/capitalized) and etc.
		In HDD management interface, you can click it to switch HDD record information and other information (Menu prompt)
		Realize other special functions.
Record	REC	Manually stop/start recording, working with direction keys or numeral keys to select the recording channel.
Window switch	Mult	Click it to switch one-window/multiple-window.
Shuttle(outer ring)		In real-time monitor mode it works as left/right direction key. Playback mode, counter clockwise to forward and clock wise to backward.
Jog(inner dial)		Up/down direction key. Playback mode, turn the inner dial to realized frame by frame playback. (Only applies to some special versions.)
USB port		To connect USB storage device, USB mouse, burner and etc.
Record light	1-32	For 4/8/16 channel device: indication light on means that the channel is in recording.

		For 32 channel device: Indication Light on: 1-16 channel is in recording Indication Light flashes: 17-32 channel is in recording Indication Light normally on: the corresponding channels are in recording
Remote control indication light	ACT	Remote control indication light
Status indication light	Status	The light is on if device operates properly.
Power indication light	PWR	Power indication light
IR Receiver	IR	It is to receive the signal from the remote control.

2.1.10 HCVR48XXS-S2/ XVR58XXS/ XVR78XXS Series

The front panel is shown as below. See Figure 2-10.

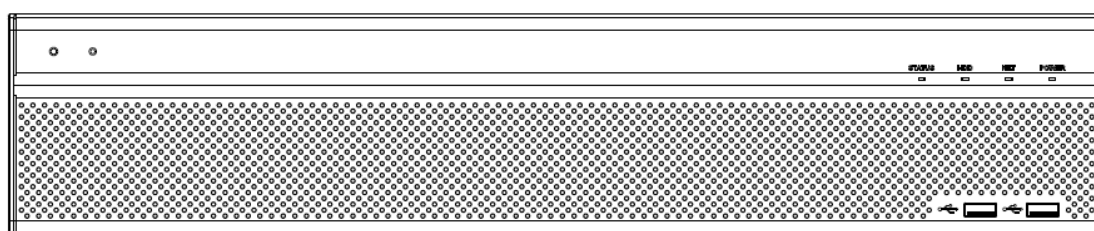



Figure 2-10

Please refer to the following sheet for front panel button information.

Icon	Name	Function
STATUS	Status indicator light	The blue light is on when the device is working properly.
HDD	HDD status indicator light	The blue light is on when the HDD is malfunction.
NET	Network status indicator light	The blue light is on when the network connection is abnormal.
POWER	Power status indicator light	The blue light is on when the power connection is OK.
	USB2.0 port	Connect to peripheral USB 2.0 storage device, mouse, burner and etc.

2.1.11 XVR1A04/XVR1A08 Series

The front panel is shown as below. See Figure 2-11.



Figure 2-11

2.2 Rear Panel

2.2.1 HCVR5104C Series

The HCVR5104C rear panel is shown as below. See Figure 2-12.

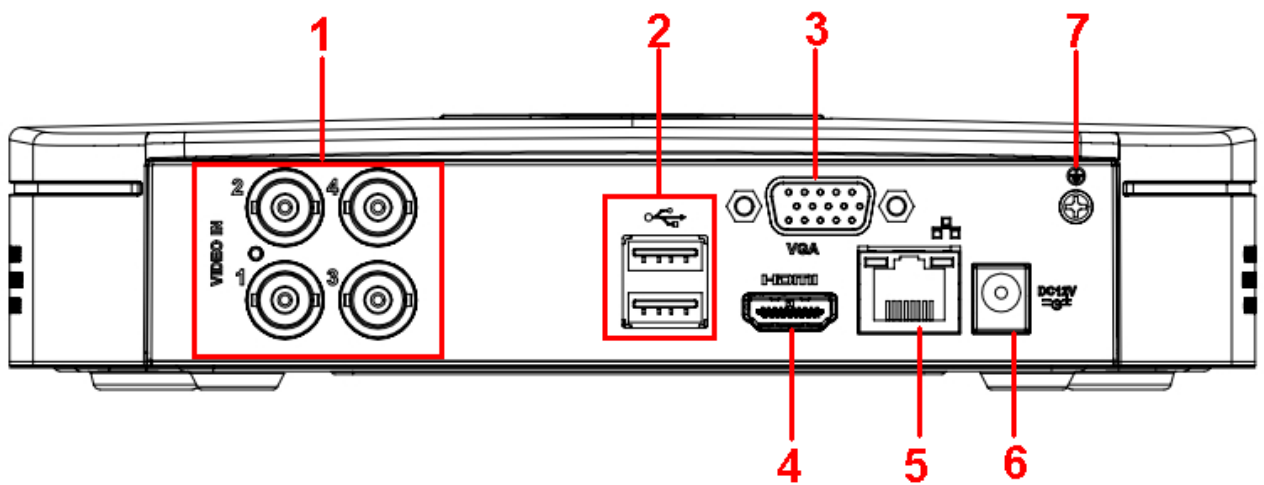





Figure 2-12

Please refer to the following sheet for detailed information.

SN	Icon	Name	Note
1	VIDEO IN	Video input port	Connect to analog camera, video input signal.
2		USB2.0 port	Connect to USB storage device, mouse, burning DVD-ROM and etc.
3	VGA	VGA video output port	VGA video output port. Output analog video signal. Can connect to the monitor to view analog video output.
4	HDMI	High definition media interface	High definition audio and video signal output port. It transmits uncompressed high definition video and multiple-channel data to the HDMI port of the display device.

5		Network port	100M Ethernet port
6		Power input port	Input 12V DC.
7		GND	Ground end

2.2.2 HCVR5104C-V2/HCVR5108C-V2 Series

The HCVR5104C-V2 rear panel is shown as below. See Figure 2-13.

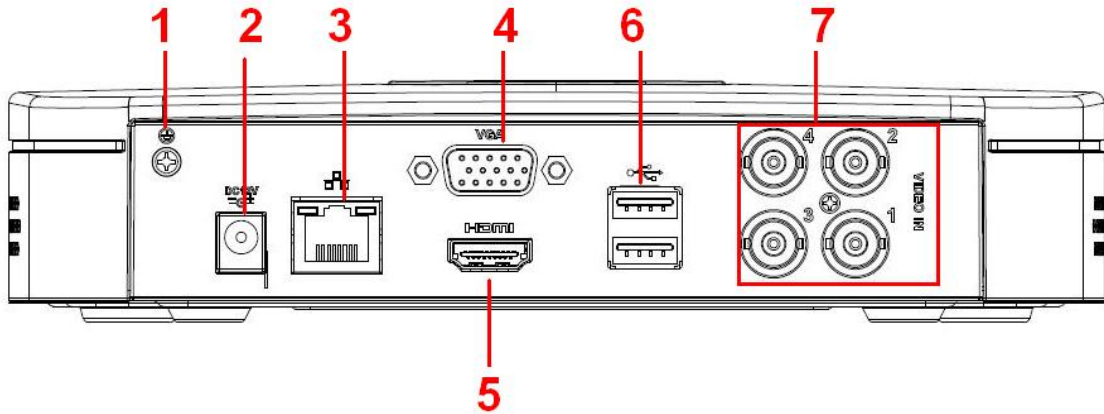

Figure 2-13

The HCVR5108C-V2 rear panel is shown as below. See Figure 2-14.

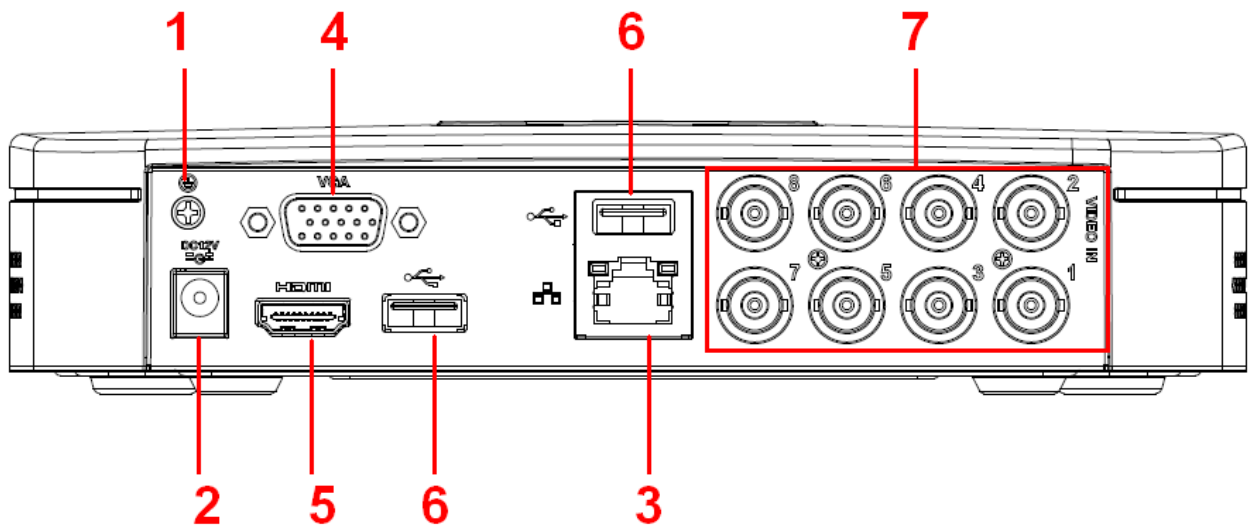





Figure 2-14

Please refer to the following sheet for detailed information.

SN	Icon	Name	Note
1		GND	Ground end
2		Power input port	Input 12V DC.

3		Network port	100M Ethernet port
4	VGA	VGA video output port	VGA video output port. Output analog video signal. Can connect to the monitor to view analog video output.
5	HDMI	High definition media interface	High definition audio and video signal output port. It transmits uncompressed high definition video and multiple-channel data to the HDMI port of the display device.
6		USB2.0 port	Connect to USB storage device, mouse, burning DVD-ROM and etc.
7	VIDEO IN	Video input port	Connect to analog camera, video input signal.

2.2.3 HCVR7104C-V2 Series

The HCVR7104C-V2 rear panel is shown as below. See Figure 2-15.

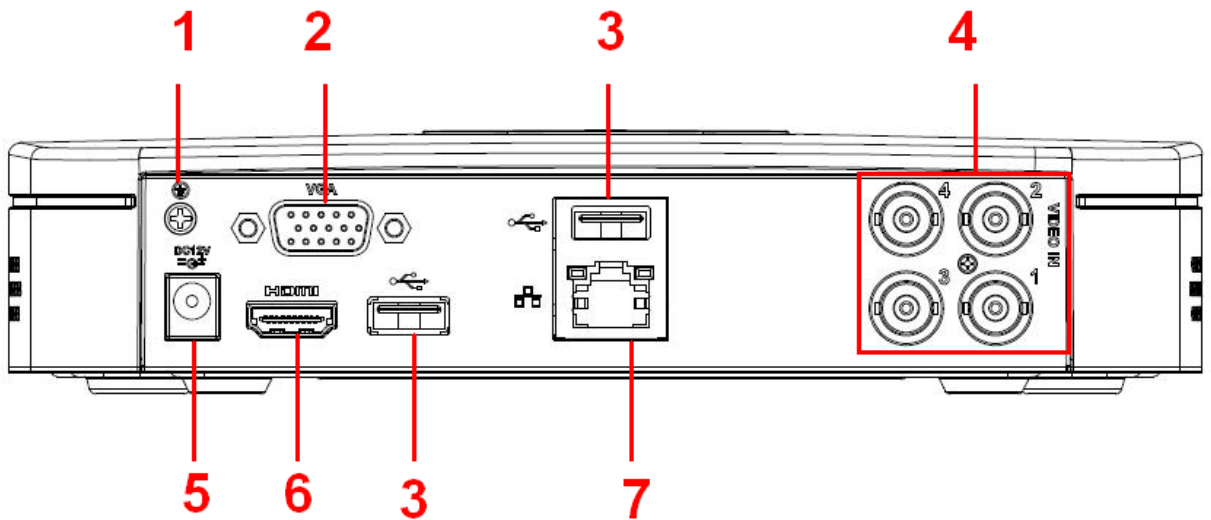





Figure 2-15

Please refer to the following sheet for detailed information.

SN	Icon	Name	Note
1		GND	Ground end
2	VGA	VGA video output port	VGA video output port. Output analog video signal. Can connect to the monitor to view analog video output.

3		USB2.0 port	Connect to USB storage device, mouse, burning DVD-ROM and etc.
4	VIDEO IN	Video input port	Connect to analog camera, video input signal.
5		Power input port	Input 12V DC.
6	HDMI	High definition media interface	High definition audio and video signal output port. It transmits uncompressed high definition video and multiple-channel data to the HDMI port of the display device.
7		Network port	100M Ethernet port

2.2.4 HCVR4104/HCVR4108C-S2/HCVR2108C-S2 Series

The HCVR4104C-S2 series rear panel is shown as below. See Figure 2-16.

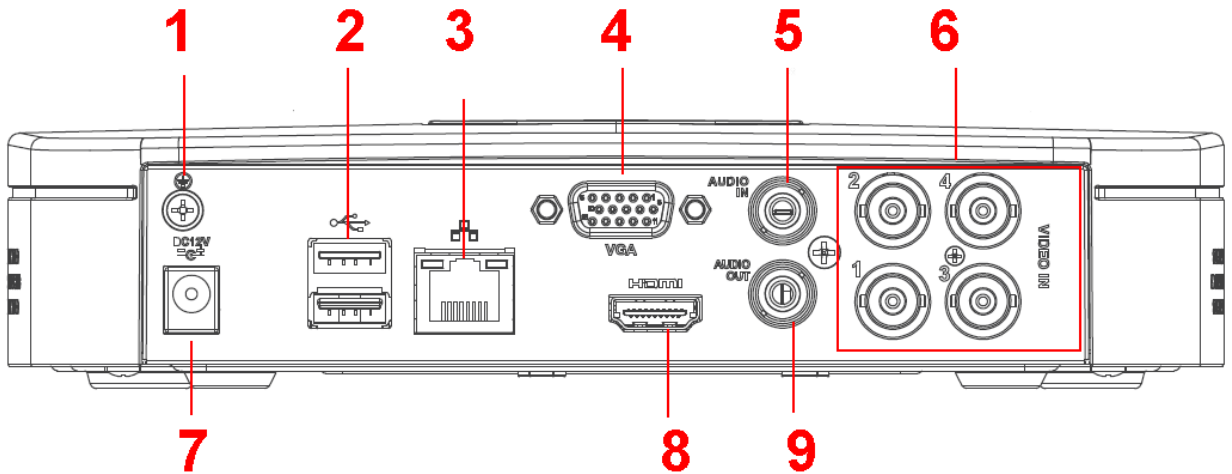

Figure 2-16

The HCVR4108C-S2/HCVR2108C-S2 series rear panel is shown as below. See Figure 2-17.

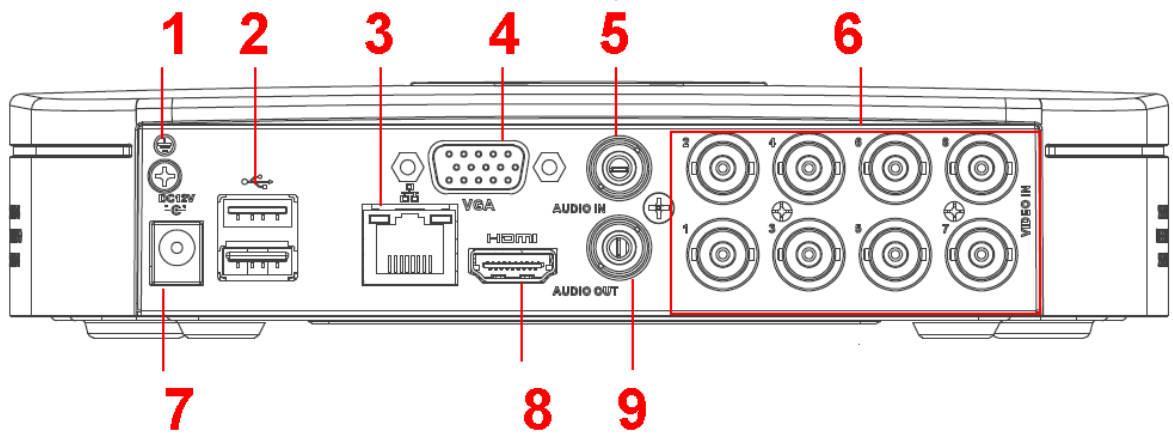

Figure 2-17

Please refer to the following sheet for detailed information.

SN	Icon	Name	Note
1		GND	Ground end
2		USB2.0 port	Connect to USB storage device, mouse, burning DVD-ROM and etc.
3		Network port	100M Ethernet port
4	VGA	VGA video output port	VGA video output port. Output analog video signal. Can connect to the monitor to view analog video output.
5	AUDIO IN	Audio input port	Connect to audio input device such as speaker.
6	VIDEO IN	Video input port	Connect to analog camera, video input signal.
7		Power input port	Input 12V DC.
8	HDMI	High definition media interface	High definition audio and video signal output port. It transmits uncompressed high definition video and multiple-channel data to the HDMI port of the display device.
9	AUDIO OUT	Audio output port	Connect to video output device such as sound box.

2.2.5 HCVR5104/5108C-S2 Series

The HCVR5104C-S2 series rear panel is shown as below. See Figure 2-18.

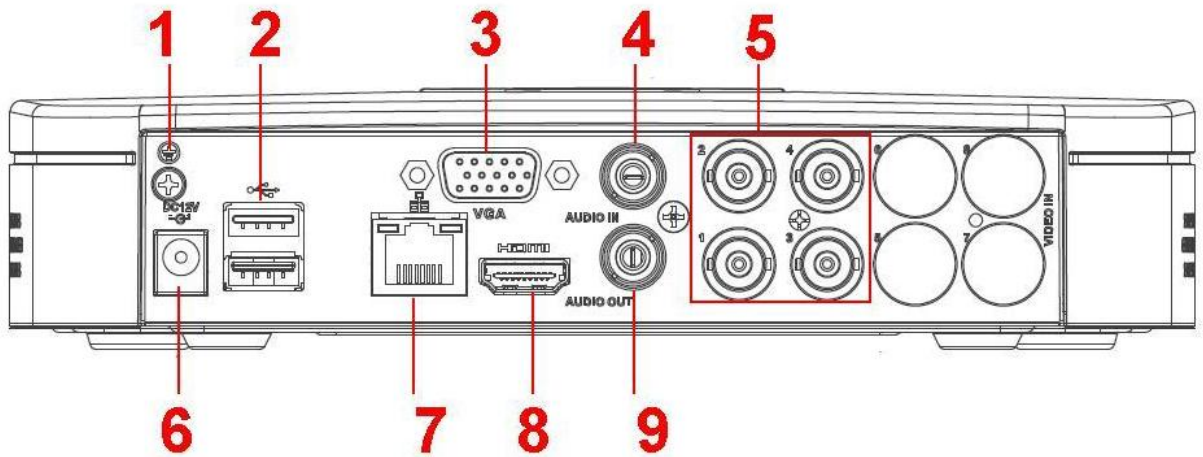

Figure 2-18

The HCVR5108C-S2 series rear panel is shown as below. See Figure 2-19.

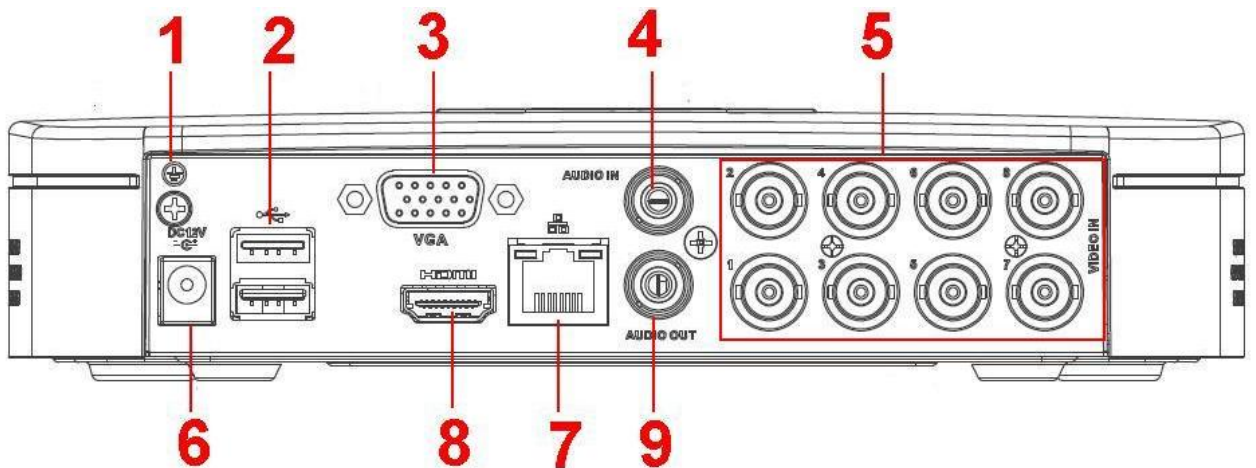



Figure 2-19

Please refer to the following sheet for detailed information.

SN	Icon	Name	Note
1		GND	Ground end
2		USB2.0 port	Connect to USB storage device, mouse, burning DVD-ROM and etc.
3	VGA	VGA video output port	VGA video output port. Output analog video signal. Can connect to the monitor to view analog video output.
4	AUDIO IN	Audio input port	Connect to audio input device such as speaker.
5	VIDEO IN	Video input port	Connect to analog camera, video input signal.

6		Power input port	Input 12V DC.
7		Network port	100M Ethernet port
8	HDMI	High definition media interface	High definition audio and video signal output port. It transmits uncompressed high definition video and multiple-channel data to the HDMI port of the display device.
9	AUDIO OUT	Audio output port	Connect to video output device such as sound box.

2.2.6 HCVR7104C-S2 Series

The HCVR7104C-S2 series rear panel is shown as below. See Figure 2-20.

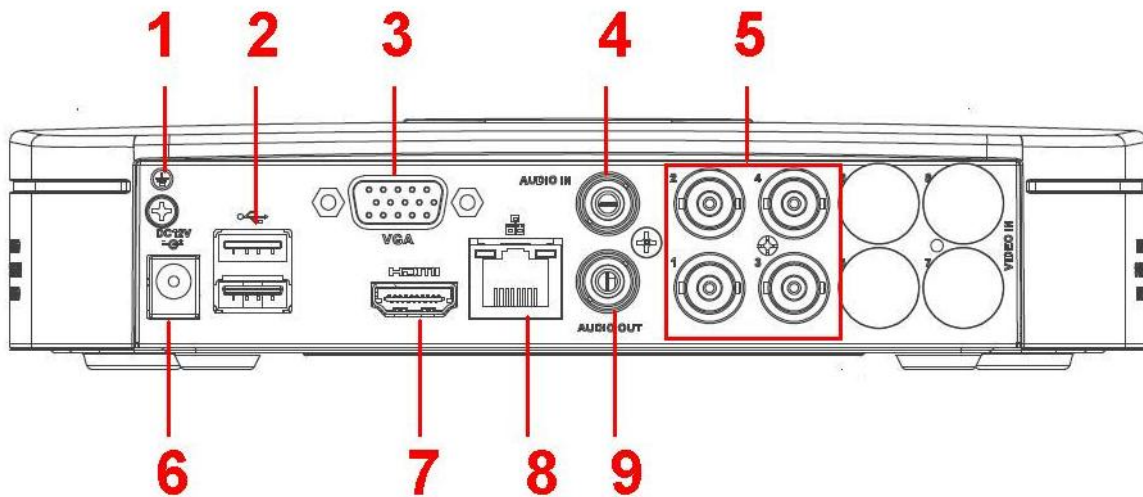





Figure 2-20

Please refer to the following sheet for detailed information.

SN	Icon	Name	Note
1		GND	Ground end
2		USB2.0 port	Connect to USB storage device, mouse, burning DVD-ROM and etc.
3	VGA	VGA video output port	VGA video output port. Output analog video signal. Can connect to the monitor to view analog video output.
4	AUDIO IN	Audio input port	Connect to audio input device such as speaker.
5	VIDEO IN	Video input port	Connect to analog camera, video input signal.

6		Power input port	Input 12V DC.
7	HDMI	High definition media interface	High definition audio and video signal output port. It transmits uncompressed high definition video and multiple-channel data to the HDMI port of the display device.
8		Network port	100M Ethernet port
9	AUDIO OUT	Audio output port	Connect to video output device such as sound box.

2.2.7 HCVR410XC-S3/HCVR510XC-S3/7104C-S3/XVR410XC/XVR510XC/7104C/XVR5104C-4M/ XVR41XXC-S2/ XVR51XXC-S2 Series

These series rear panel is shown as below. See Figure 4-156.

The following figure is based on the HCVR4108C-S3/5108C-S3/XVR4108C/5108C/XVR41XXC-S2/XVR51XXC-S2 series.

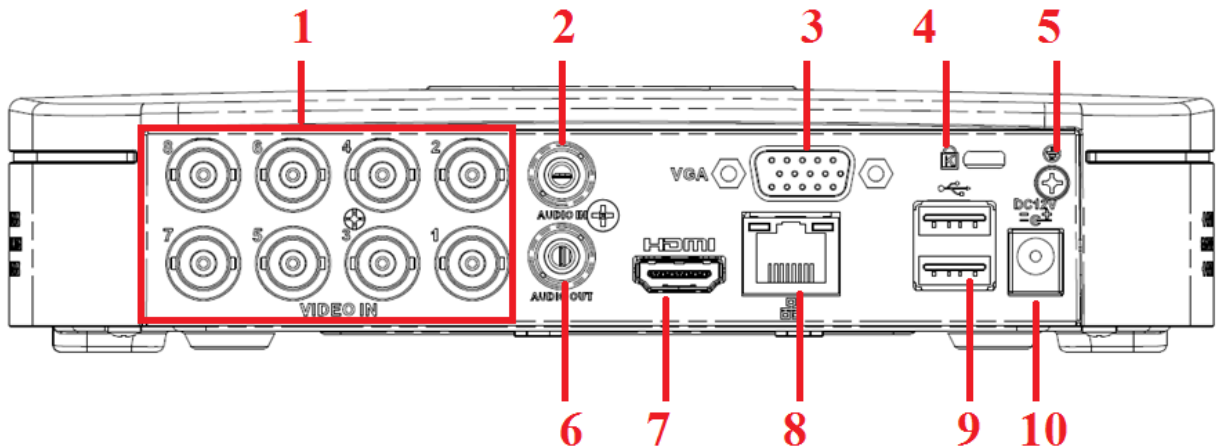







Figure 2-21

Please refer to the following sheet for detailed information.

SN	Icon	Name	Note
1	VIDEO IN	Video input port	Connect to analog camera, video input signal.
2	AUDIO IN	Audio input port	Connect to audio input device such as speaker.
3	VGA	VGA video output port	VGA video output port. Output analog video signal. Can connect to the monitor to view analog video output.
4		Power cable fastener	Use clamp to secure the power cable on the device in case there is any loss.

5		GND	Ground end
6	AUDIO OUT	Audio output port	Connect to video output device such as sound box.
7	HDMI	High definition media interface	High definition audio and video signal output port. It transmits uncompressed high definition video and multiple-channel data to the HDMI port of the display device.
8		Network port	100M Ethernet port
9		USB2.0 port	Connect to USB storage device, mouse, burning DVD-ROM and etc.
10		Power input port	Input 12V DC.

2.2.8 HCVR5104H/HCVR5108H Series

The HCVR5104H series rear panel is shown as below. See Figure 2-22.

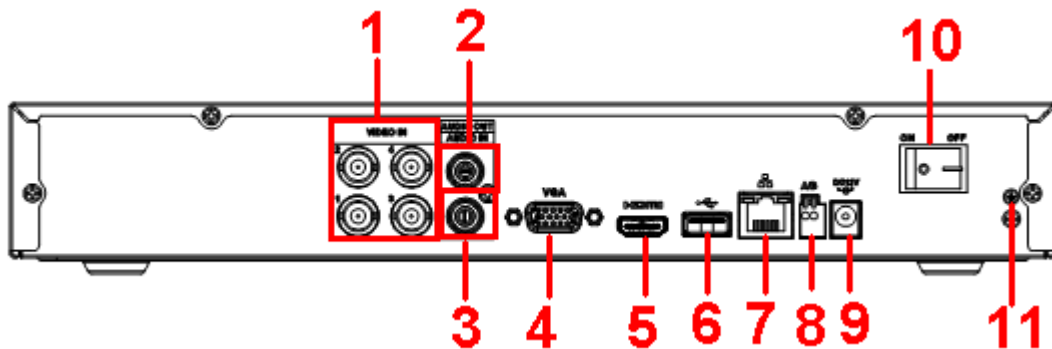

Figure 2-22

The HCVR5108H series rear panel is shown as below. See Figure 2-23.

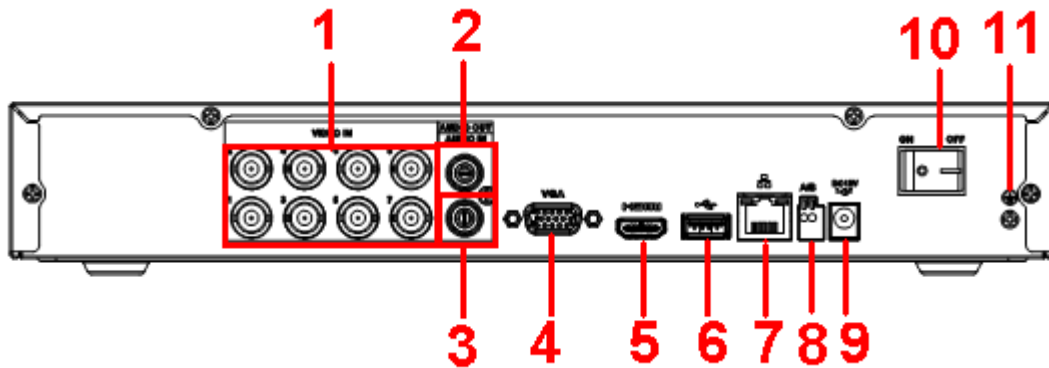



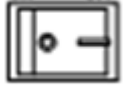



Figure 2-23

Please refer to the following sheet for detailed information.

SN	Icon	Name	Note
1	VIDEO IN	Video input port	Connect to analog camera, video input signal.
2	AUDIO OUT	Audio output port	Connect to video output device such as sound box.
3	AUDIO IN	Audio input port	Connect to audio input device such as speaker.
4	VGA	VGA video output port	VGA video output port. Output analog video signal. Can connect to the monitor to view analog video output.
5	HDMI	High definition media interface	High definition audio and video signal output port. It transmits uncompressed high definition video and multiple-channel data to the HDMI port of the display device.
6		USB2.0 port	Connect to USB storage device, mouse, burning DVD-ROM and etc.
7		Network port	100M Ethernet port
8	A	RS485 (RS-485) communication port	RS485_A port. It is the cable A. You can connect to the control devices such as speed dome PTZ.
	B		RS485_B. It is the cable B. You can connect to the control devices such as speed dome PTZ.
9		Power input port	Input 12V DC.
10		Power on-off button	Power on/off button.
11		GND	Ground end

2.2.9 HCVR5104H-V2/HCVR5108H-V2/HCVR5116H-V2 Series

The HCVR5104H-V2 series rear panel is shown as below. See Figure 2-24.

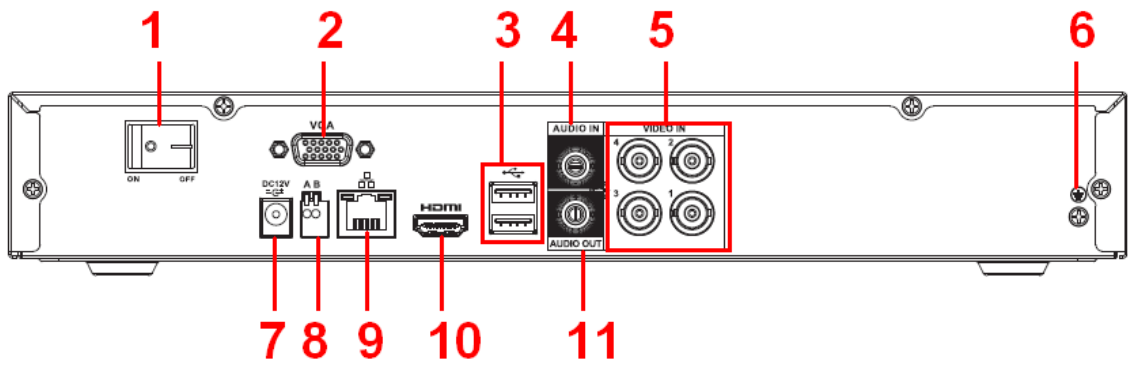

Figure 2-24

The HCVR5108H-V2 series rear panel is shown as below. See Figure 2-25.

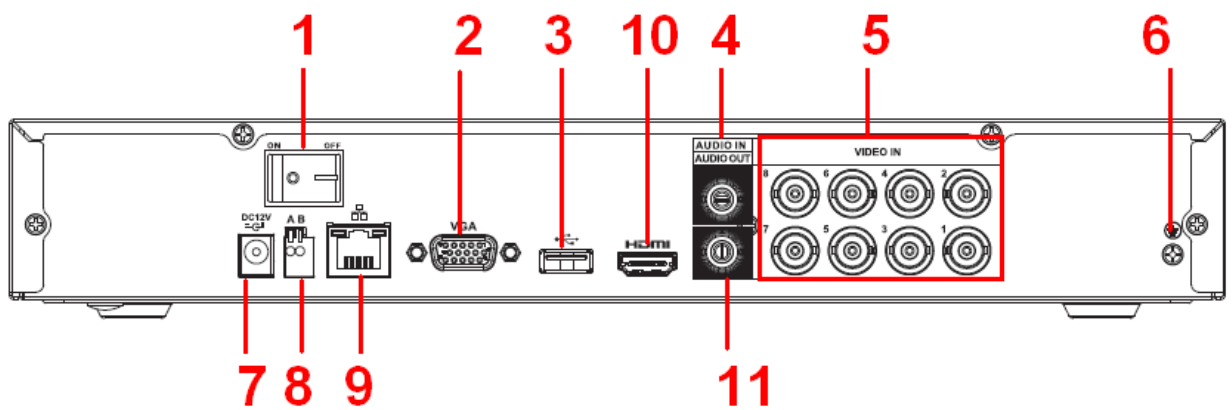

Figure 2-25

The HCVR5116H-V2 series rear panel is shown as below. See Figure 2-26.

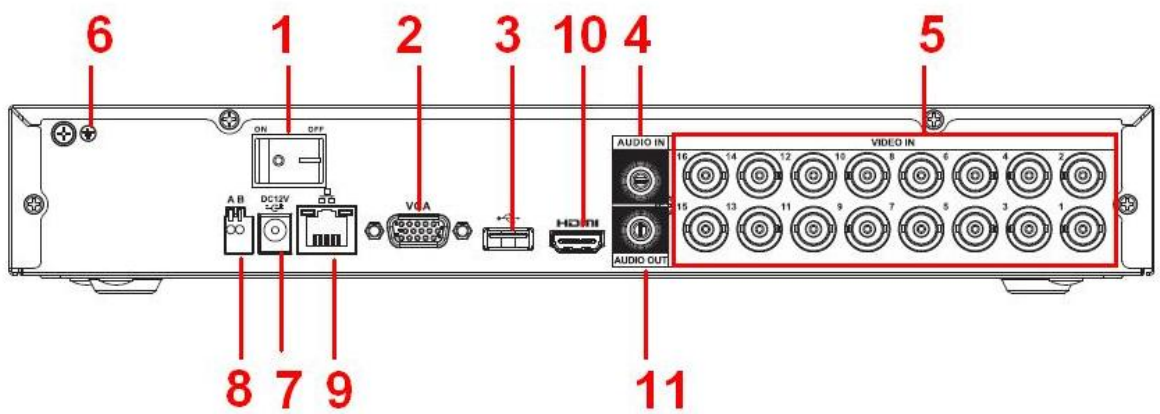
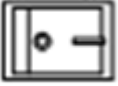





Figure 2-26

Please refer to the following sheet for detailed information.

SN	Icon	Name	Note
----	------	------	------

1		Power on-off button	Power on/off button.
2	VGA	VGA video output port	VGA video output port. Output analog video signal. Can connect to the monitor to view analog video output.
3		USB2.0 port	Connect to USB storage device, mouse, burning DVD-ROM and etc.
4	AUDIO IN	Audio input port	Connect to audio input device such as speaker.
5	VIDEO IN	Video input port	Connect to analog camera, video input signal.
6		GND	Ground end
7		Power input port	Input 12V DC.
8	A	RS485 (RS-485) communication port	RS485_A port. It is the cable A. You can connect to the control devices such as speed dome PTZ.
	B		RS485_B. It is the cable B. You can connect to the control devices such as speed dome PTZ.
9		Network port	100M Ethernet port
10	HDMI	High definition media interface	High definition audio and video signal output port. It transmits uncompressed high definition video and multiple-channel data to the HDMI port of the display device.
11	AUDIO OUT	Audio output port	Connect to video output device such as sound box.

2.2.10 HCVR5104HC/HCVR5108HC Series

The HCVR5104HC series rear panel is shown as below. See Figure 2-27.

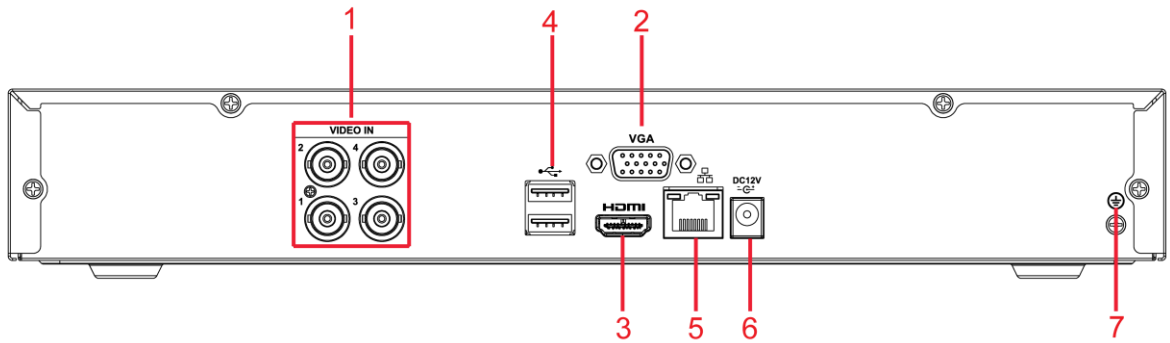

Figure 2-27

The HCVR5108HC series rear panel is shown as below. See Figure 2-28.

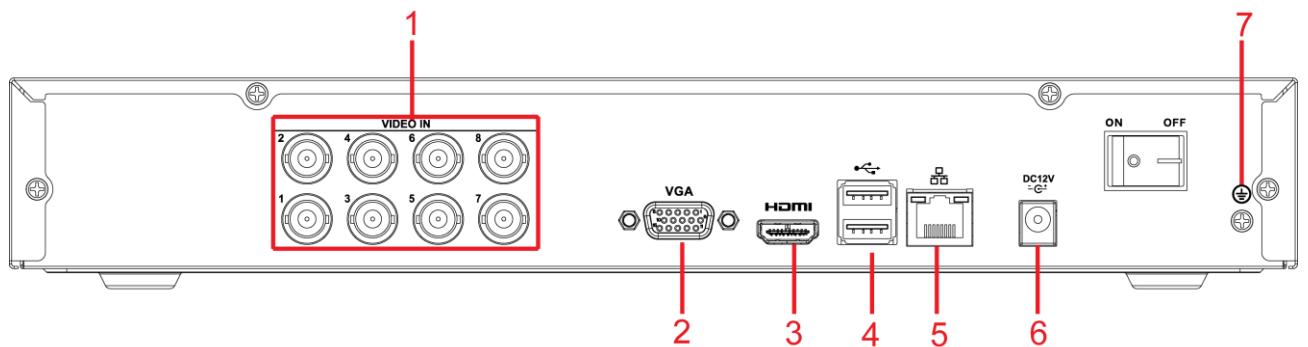





Figure 2-28

Please refer to the following sheet for detailed information.

SN	Icon	Name	Note
1	VIDEO IN	Video input port	Connect to analog camera, video input signal.
2	VGA	VGA video output port	VGA video output port. Output analog video signal. Can connect to the monitor to view analog video output.
3	HDMI	High definition media interface	High definition audio and video signal output port. It transmits uncompressed high definition video and multiple-channel data to the HDMI port of the display device.
4		USB2.0 port	Connect to USB storage device, mouse, burning DVD-ROM and etc.
5		Network port	100M Ethernet port
6		Power input port	Input 12V DC.
7		GND	Ground end

2.2.11 HCVR5104HC-V2/HCVR5108HC-V2/HCVR5116HC-V2 Series

The HCVR5104HC-V2 series rear panel is shown as below. See Figure 2-29.

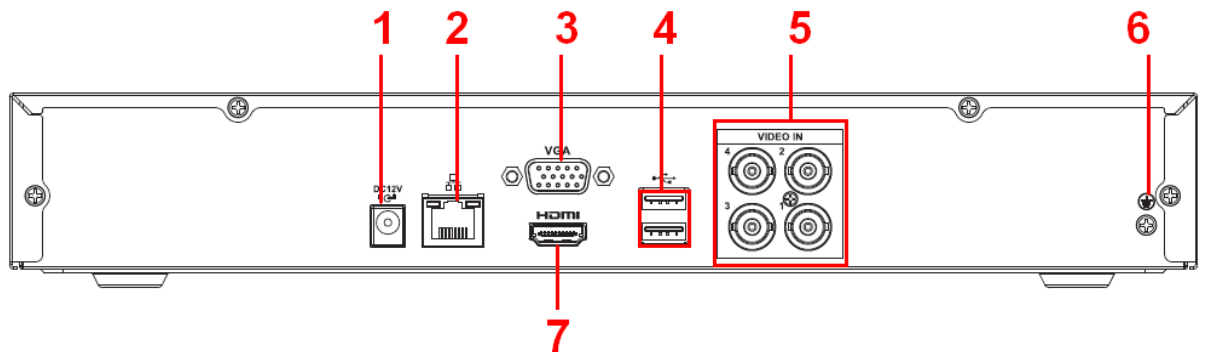

Figure 2-29

The HCVR5108HC-V2 series rear panel is shown as below. See Figure 2-30.

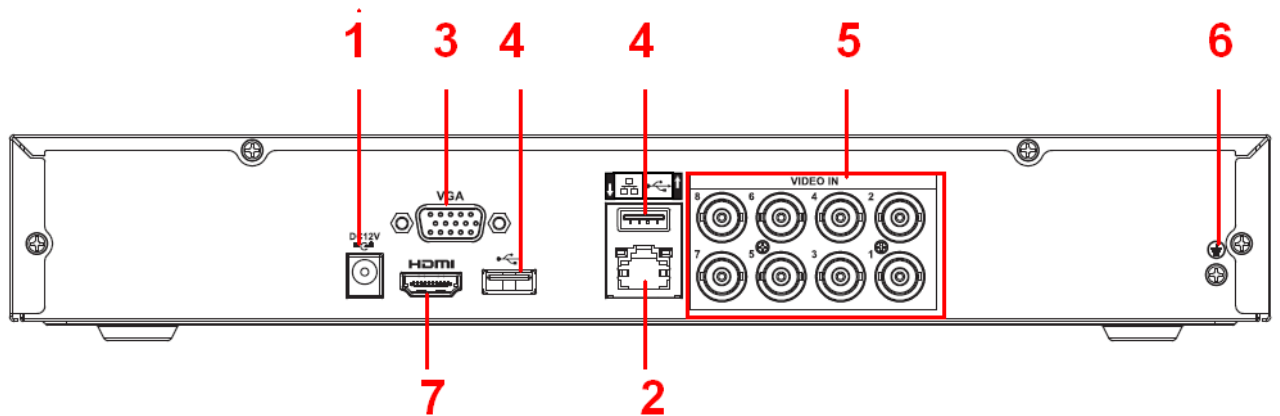

Figure 2-30

The HCVR5116HC-V2 series rear panel is shown as below. See Figure 2-31.

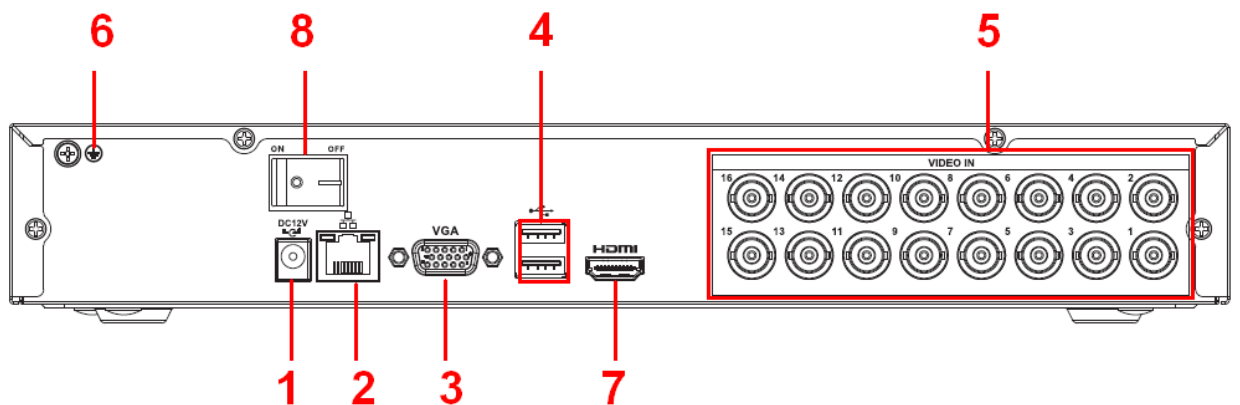







Figure 2-31

Please refer to the following sheet for detailed information.

SN	Icon	Name	Note
1		Power input port	Input 12V DC.
2		Network port	100M Ethernet port
3	VGA	VGA video output port	VGA video output port. Output analog video signal. Can connect to the monitor to view analog video output.
4		USB2.0 port	Connect to USB storage device, mouse, burning DVD-ROM and etc.
5	VIDEO IN	Video input port	Connect to analog camera, video input signal.
6		GND	Ground end
7	HDMI	High definition media interface	High definition audio and video signal output port. It transmits uncompressed high definition video and multiple-channel data to the HDMI port of the display device.
8		Power on-off button	Power on/off button.

2.2.12 HCVR5104HE/HCVR5108HE Series

The HCVR5104HE4 series rear panel is shown as below. See Figure 2-32.

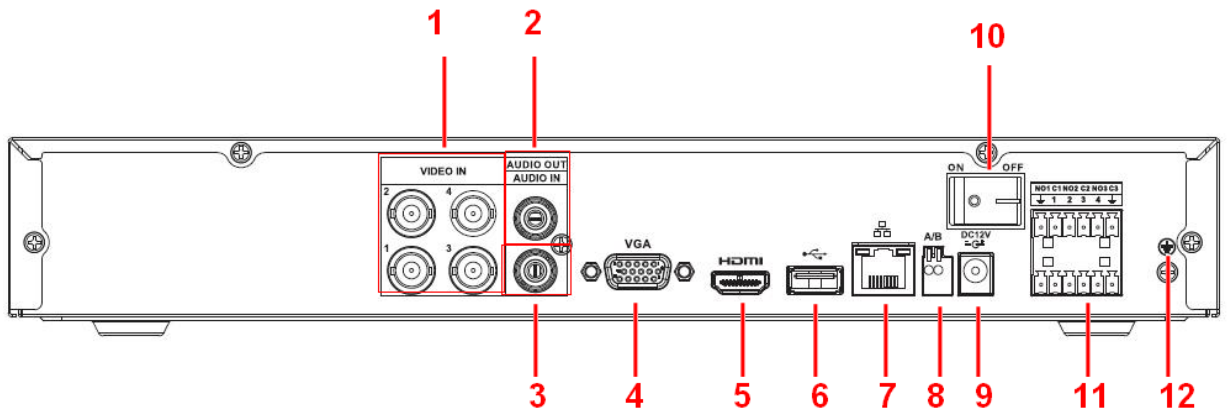

Figure 2-32

The HCVR5108HE series rear panel is shown as below. See Figure 2-33.

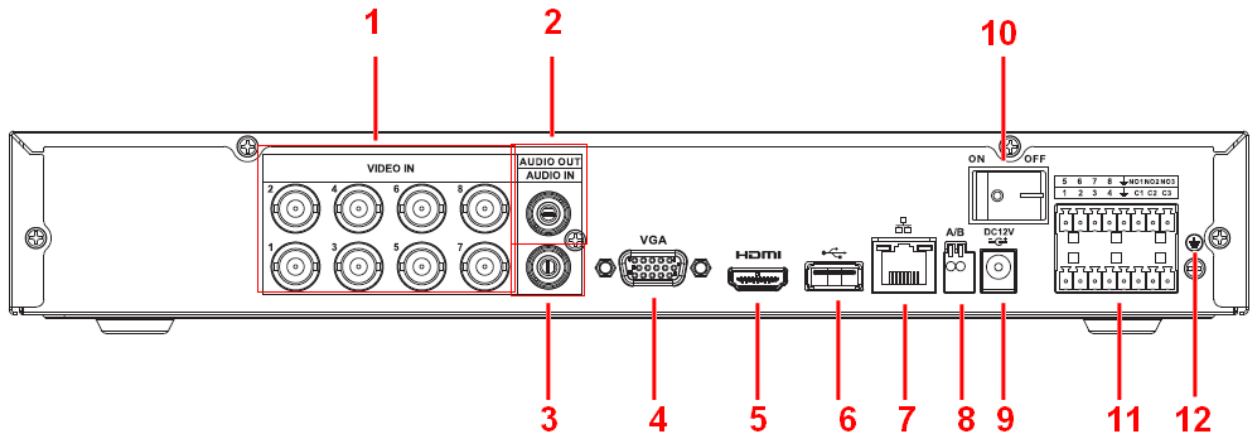



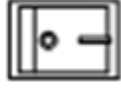
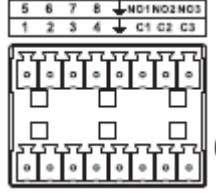



Figure 2-33

Please refer to the following sheet for detailed information.

SN	Icon	Name	Note
1	VIDEO IN	Video input port	Connect to analog camera, video input signal.
2	AUDIO OUT	Audio output port	Connect to video output device such as sound box.
3	AUDIO IN	Audio input port	Connect to audio input device such as speaker.
4	VGA	VGA video output port	VGA video output port. Output analog video signal. Can connect to the monitor to view analog video output.
5	HDMI	High definition media interface	High definition audio and video signal output port. It transmits uncompressed high definition video and multiple-channel data to the HDMI port of the display device.
6		USB2.0 port	Connect to USB storage device, mouse, burning DVD-ROM and etc.
7		Network port	100M Ethernet port
8	A	RS485 (RS-485) communication port	RS485_A port. It is the cable A. You can connect to the control devices such as speed dome PTZ.
	B		RS485_B.It is the cable B. You can connect to the control devices such as speed dome

			PTZ.
9	DC 12V 	Power input port	Input 12V DC.
10		Power on-off button	Power on/off button.
11		Alarm input/Alarm output	Input/output alarm signal.
12		GND	Ground end

2.2.13 HCVR5104HE-V2/HCVR5108HE-V2/HCVR5116HE-V2 Series

The HCVR5104HE-V2 series rear panel is shown as below. See Figure 2-34.

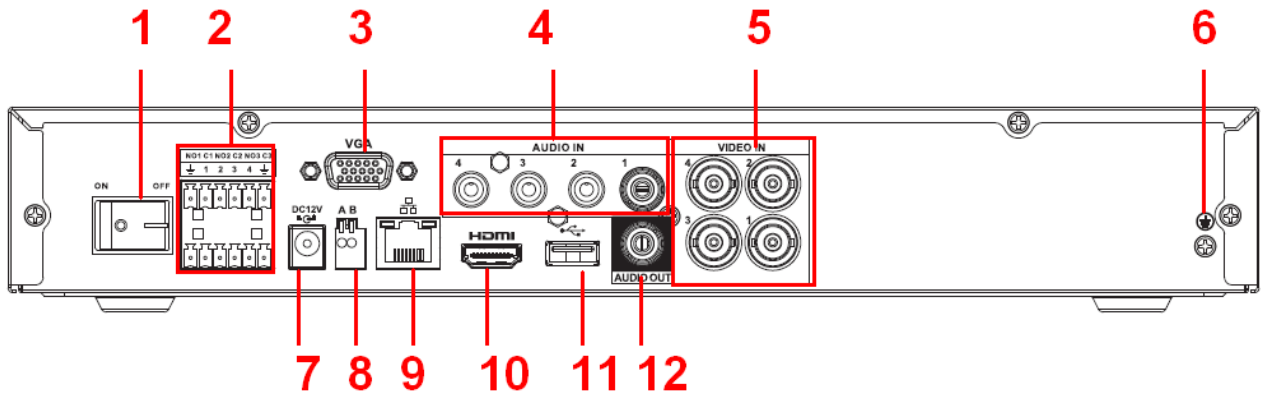

Figure 2-34

The HCVR5108HE-V2 series rear panel is shown as below. See Figure 2-35.

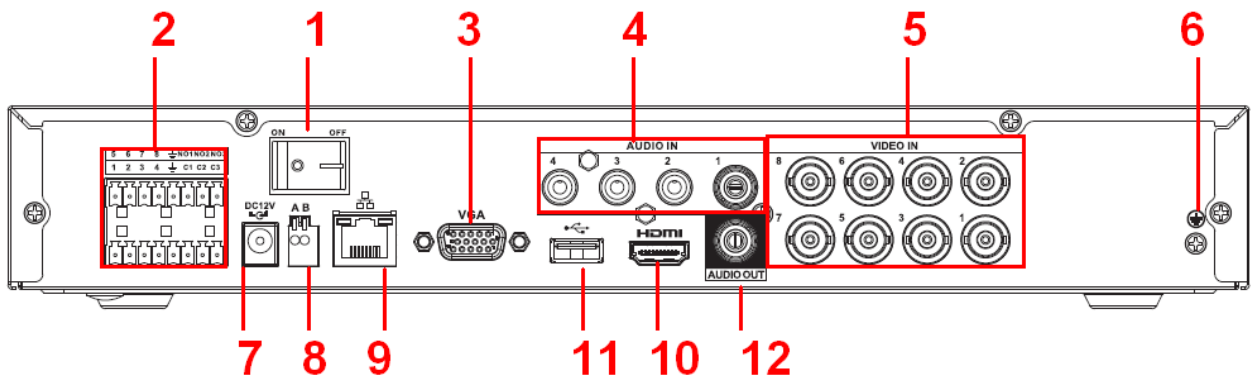

Figure 2-35

The HCVR5116HE-V2 series rear panel is shown as below. See Figure 2-36.

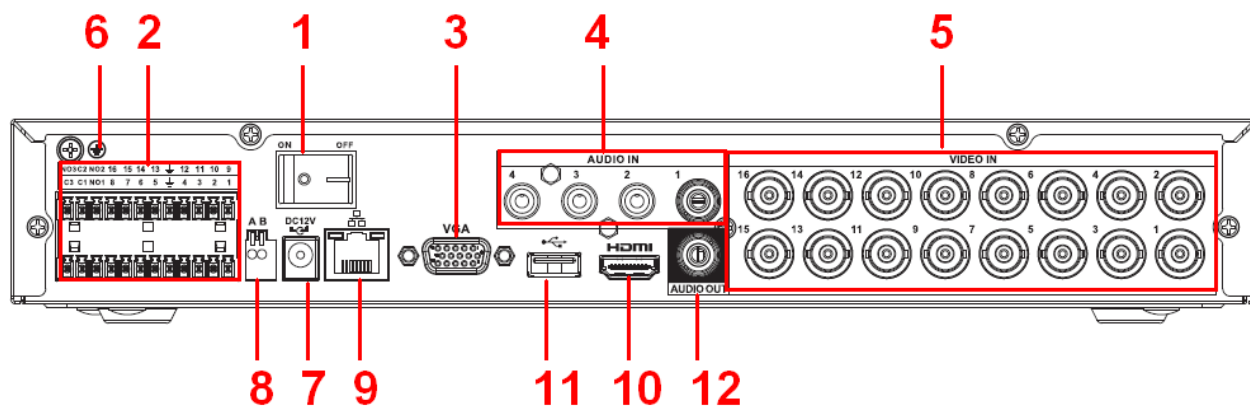



Figure 2-36

Please refer to the following sheet for detailed information.

SN	Icon	Name	Note
1		Power on-off button	Power on/off button.
2		Alarm input/Alarm output	Input/output alarm signal.
3	VGA	VGA video output port	VGA video output port. Output analog video signal. Can connect to the monitor to view analog video output.
4	AUDIO IN	Audio input port	Connect to audio input device such as speaker.
5	VIDEO IN	Video input port	Connect to analog camera, video input signal.
6		GND	Ground end
7		Power input port	Input 12V DC.
8	A	RS485 (RS-485) communication port	RS485_A port. It is the cable A. You can connect to the control devices such as speed dome PTZ.
	B		RS485_B. It is the cable B. You can connect to the control devices such as speed dome PTZ.
9		Network port	100M Ethernet port

10	HDMI	High definition media interface	High definition audio and video signal output port. It transmits uncompressed high definition video and multiple-channel data to the HDMI port of the display device.
11		USB2.0 port	Connect to USB storage device, mouse, burning DVD-ROM and etc.
12	AUDIO OUT	Audio output port	Connect to video output device such as sound box.

2.2.14 HCVR7104H-V2/HCVR7108H-V2 Series

The HCVR7104H-V2 series rear panel is shown as below. See Figure 2-37.

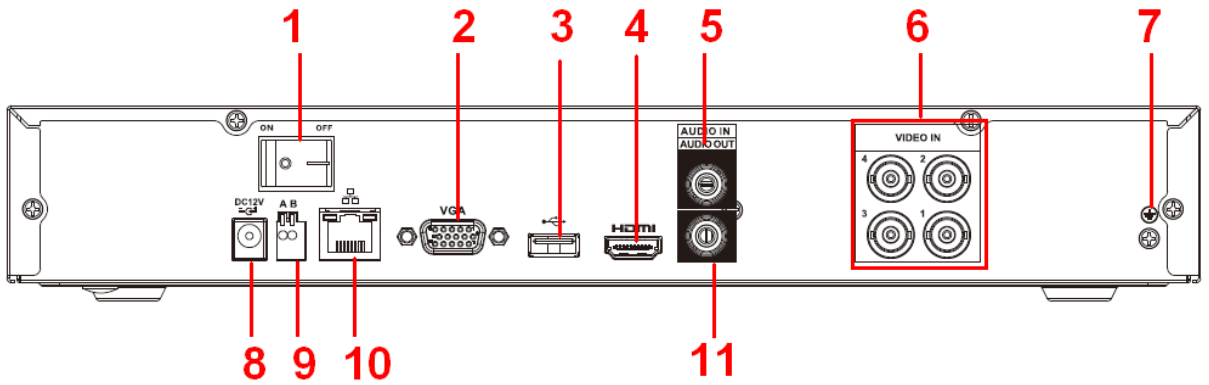

Figure 2-37

The HCVR7108H-V2 series rear panel is shown as below. See Figure 2-38.

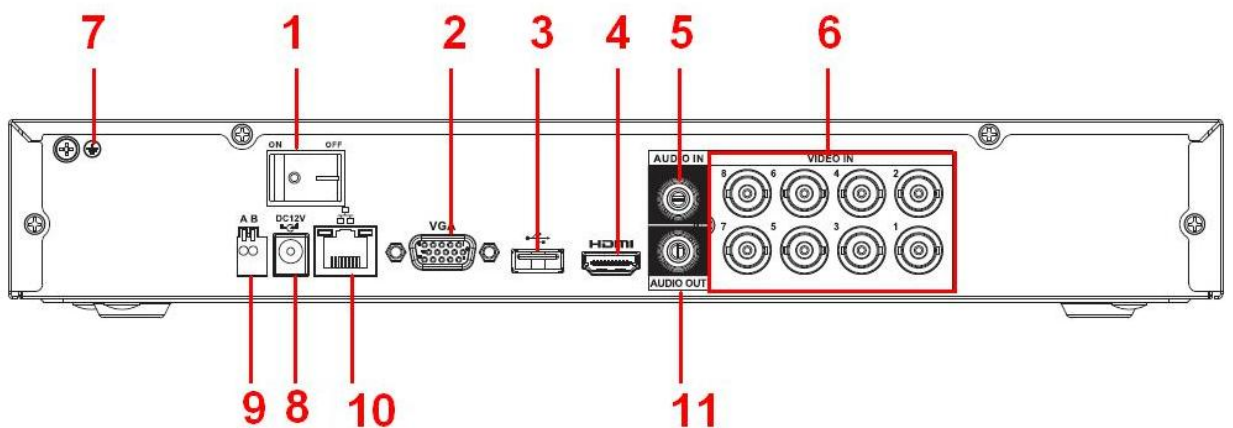







Figure 2-38

Please refer to the following sheet for detailed information.

SN	Icon	Name	Note
----	------	------	------

1		Power on-off button	Power on/off button.
2	VGA	VGA video output port	VGA video output port. Output analog video signal. Can connect to the monitor to view analog video output.
3		USB2.0 port	Connect to USB storage device, mouse, burning DVD-ROM and etc.
4	HDMI	High definition media interface	High definition audio and video signal output port. It transmits uncompressed high definition video and multiple-channel data to the HDMI port of the display device.
5	AUDIO IN	Audio input port	Connect to audio input device such as speaker.
6	VIDEO IN	Video input port	Connect to analog camera, video input signal.
7		GND	Ground end
8		Power input port	Input 12V DC.
9	A	RS485 (RS-485) communication port	RS485_A port. It is the cable A. You can connect to the control devices such as speed dome PTZ.
	B		RS485_B. It is the cable B. You can connect to the control devices such as speed dome PTZ.
10		Network port	100M Ethernet port
11	AUDIO OUT	Audio output port	Connect to video output device such as sound box.

2.2.15 HCVR7104HC-V2/HCVR7108HC-V2 Series

The HCVR7104HC-V2 series rear panel is shown as below. See Figure 2-39.

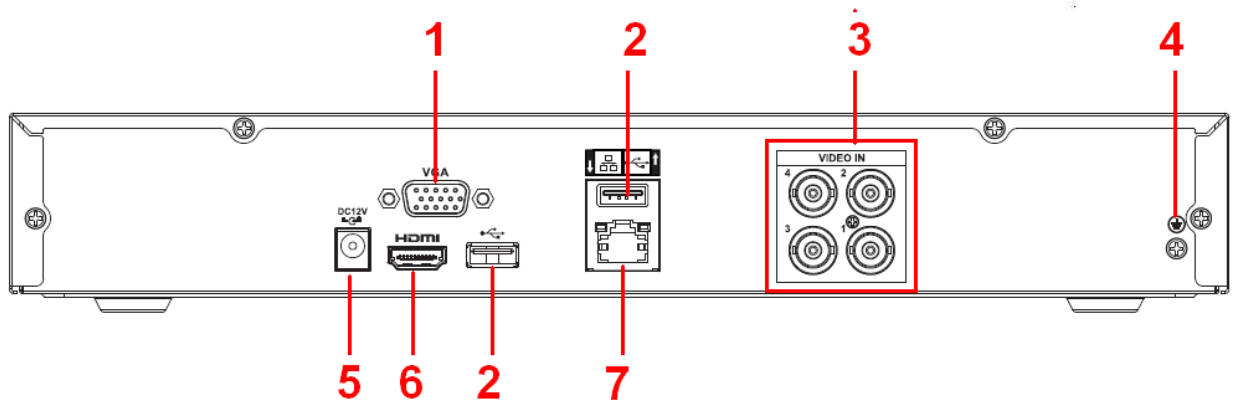

Figure 2-39

The HCVR7108HC-V2 series rear panel is shown as below. See Figure 2-40.

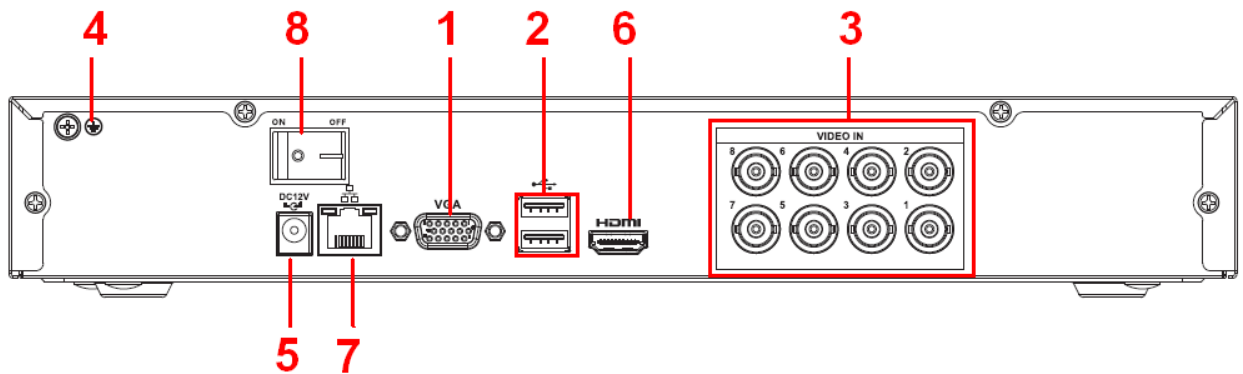







Figure 2-40

Please refer to the following sheet for detailed information.

SN	Icon	Name	Note
1	VGA	VGA video output port	VGA video output port. Output analog video signal. Can connect to the monitor to view analog video output.
2		USB2.0 port	Connect to USB storage device, mouse, burning DVD-ROM and etc.
3	VIDEO IN	Video input port	Connect to analog camera, video input signal.
4		GND	Ground end
5		Power input port	Input 12V DC.
6	HDMI	High definition media interface	High definition audio and video signal output port. It transmits uncompressed high definition video and multiple-channel data to the HDMI port of the display device.

7		Network port	100M Ethernet port
8		Power button on-off	Power on/off button.

2.2.16 HCVR7104HE-V2/HCVR7108HE-V2 Series

The HCVR7104HE-V2 series rear panel is shown as below. See Figure 2-41.

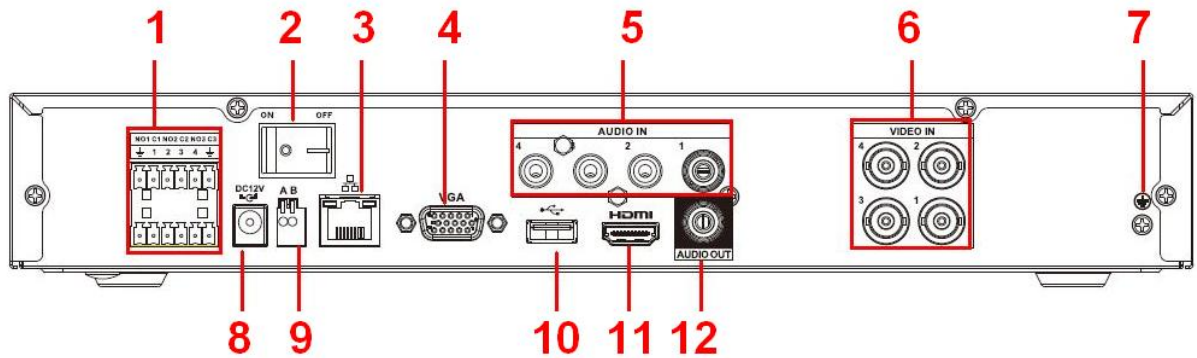

Figure 2-41

The HCVR7108HE-V2 series rear panel is shown as below. See Figure 2-42.

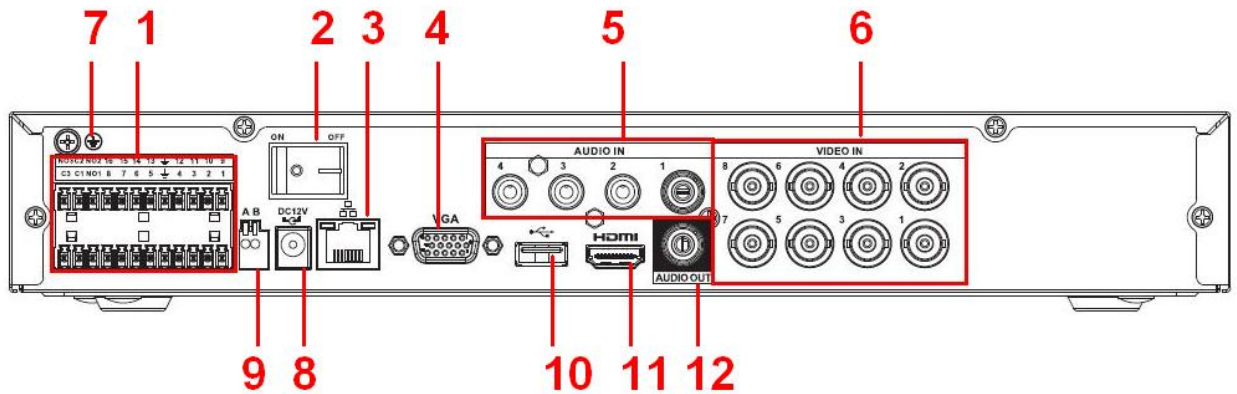
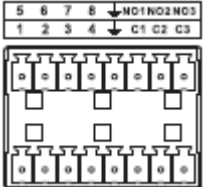







Figure 2-42

Please refer to the following sheet for detailed information.

SN	Icon	Name	Note
1		Alarm input/Alarm output	Input/output alarm signal.

2		Power on-off button	Power on/off button.
3		Network port	100M Ethernet port
4	VGA	VGA video output port	VGA video output port. Output analog video signal. Can connect to the monitor to view analog video output.
5	AUDIO IN	Audio input port	Connect to audio input device such as speaker.
6	VIDEO IN	Video input port	Connect to analog camera, video input signal.
7		GND	Ground end 0
8		Power input port	Input 12V DC.
9	A	RS485 (RS-485) communication port	RS485_A port. It is the cable A. You can connect to the control devices such as speed dome PTZ.
	B		RS485_B. It is the cable B. You can connect to the control devices such as speed dome PTZ.
10		USB2.0 port	Connect to USB storage device, mouse, burning DVD-ROM and etc.
11	HDMI	High definition media interface	High definition audio and video signal output port. It transmits uncompressed high definition video and multiple-channel data to the HDMI port of the display device.
12	AUDIO OUT	Audio output port	Connect to video output device such as sound box.

2.2.17 HCVR4104/4108/4116HE-S2 Series

The HCVR4104HE-S2 series rear panel is shown as below. See Figure 2-43.

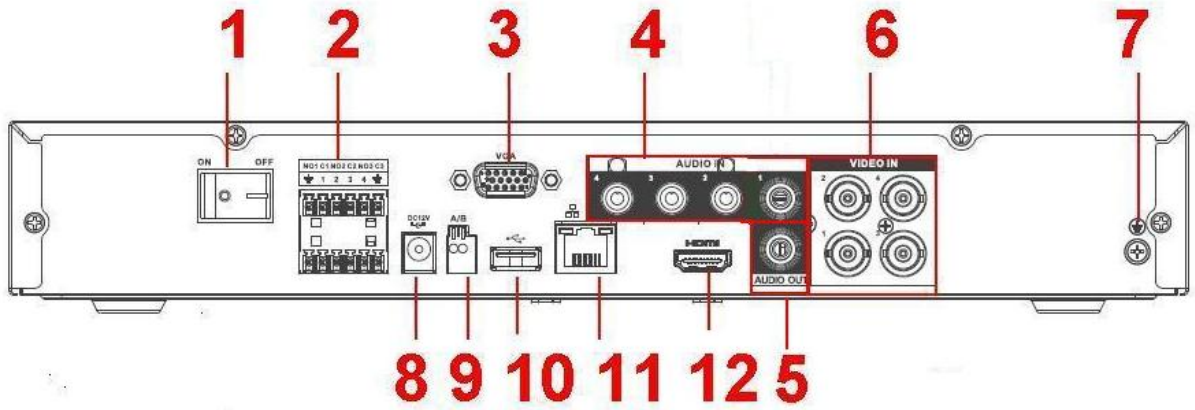

Figure 2-43

The HCVR4108HE-S2 series rear panel is shown as below. See Figure 2-44.

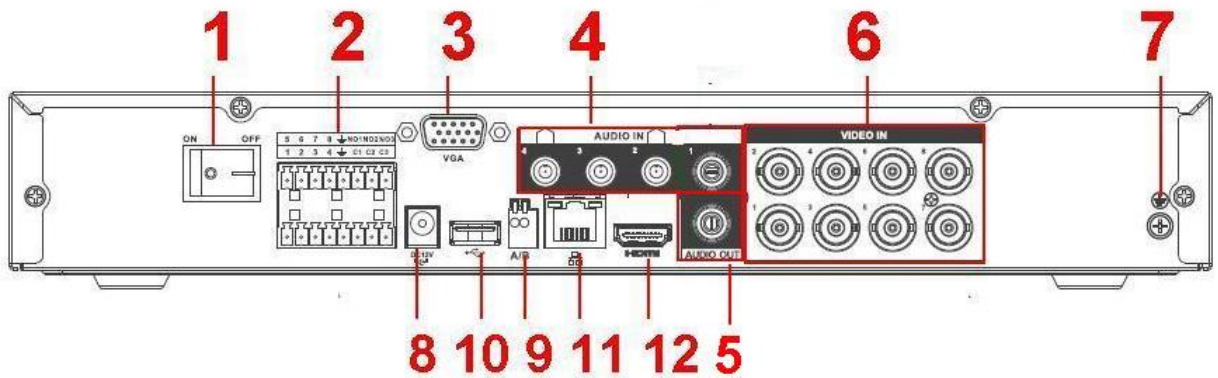

Figure 2-44

The HCVR4116HE-S2 series rear panel is shown as below. See Figure 2-45.

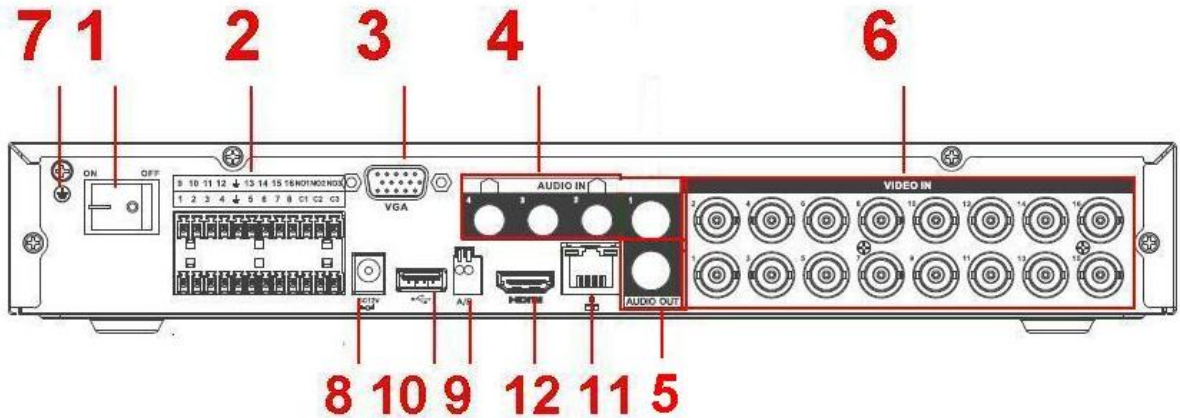

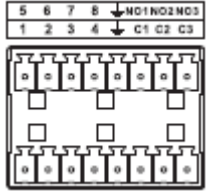





Figure 2-45

Please refer to the following sheet for detailed information.

SN	Icon	Name	Note
----	------	------	------

1		Power on-off button	Power on/off button.
2		Alarm input/Alarm output	Input/output alarm signal.
3	VGA	VGA video output port	VGA video output port. Output analog video signal. Can connect to the monitor to view analog video output.
4	AUDIO IN	Audio input port	Connect to audio input device such as speaker.
5	AUDIO OUT	Audio output port	Connect to video output device such as sound box.
6	VIDEO IN	Video input port	Connect to analog camera, video input signal.
7		GND	Ground end 0
8		Power input port	Input 12V DC.
9	A	RS485 (RS-485) communication port	RS485_A port. It is the cable A. You can connect to the control devices such as speed dome PTZ.
	B		RS485_B.It is the cable B. You can connect to the control devices such as speed dome PTZ.
10		USB2.0 port	Connect to USB storage device, mouse, burning DVD-ROM and etc.
11		Network port	100M Ethernet port
12	HDMI	High definition media interface	High definition audio and video signal output port. It transmits uncompressed high definition video and multiple-channel data to the HDMI port of the display device.

2.2.18 HCVR5104/5108/5116H-S2 Series

The HCVR5104H-S2 series rear panel is shown as below. See Figure 2-46.

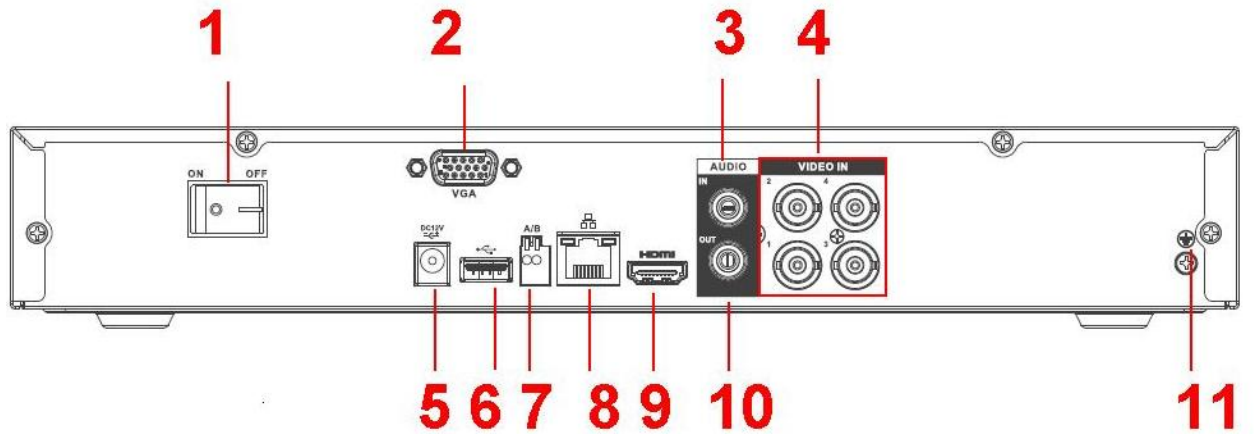

Figure 2-46

The HCVR5108H-S2 series rear panel is shown as below. See Figure 2-47.

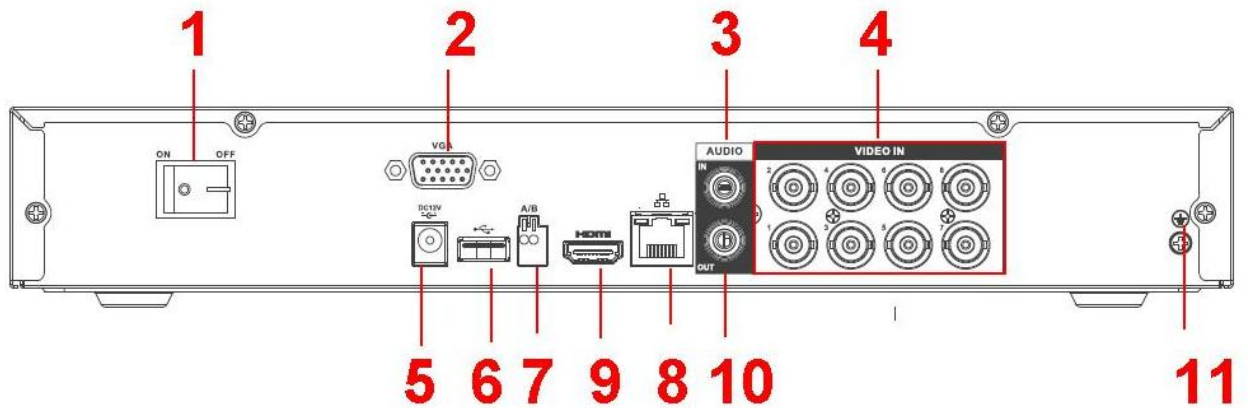

Figure 2-47

The HCVR5116H-S2 series rear panel is shown as below. See Figure 2-48.

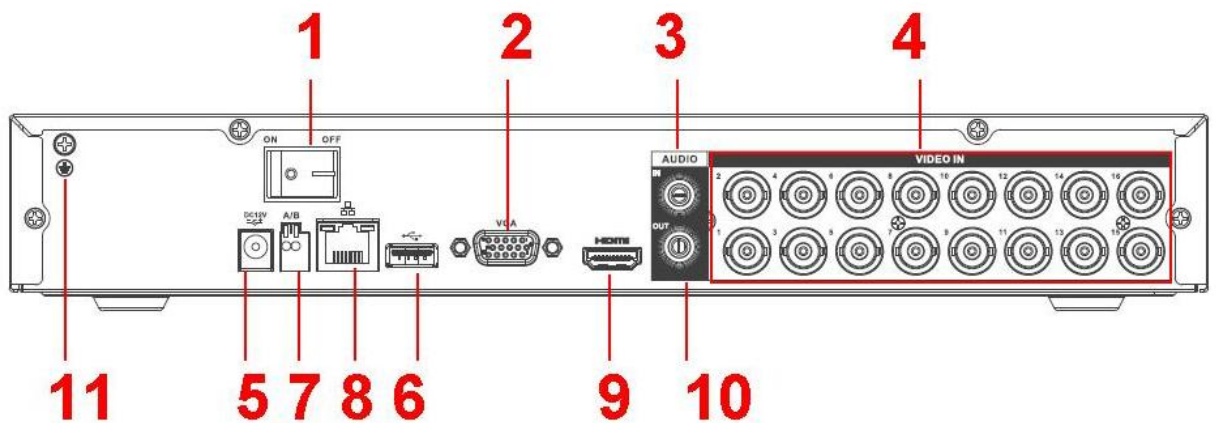







Figure 2-48

Please refer to the following sheet for detailed information.

SN	Icon	Name	Note
1		Power on-off button	Power on/off button.
2	VGA	VGA video output port	VGA video output port. Output analog video signal. Can connect to the monitor to view analog video output.
3	AUDIO IN	Audio input port	Connect to audio input device such as speaker.
4	VIDEO IN	Video input port	Connect to analog camera, video input signal.
5		Power input port	Input 12V DC.
6		USB2.0 port	Connect to USB storage device, mouse, burning DVD-ROM and etc.
7	A	RS485 (RS-485) communication port	RS485_A port. It is the cable A. You can connect to the control devices such as speed dome PTZ.
	B		RS485_B. It is the cable B. You can connect to the control devices such as speed dome PTZ.
8		Network port	100M Ethernet port
9	HDMI	High definition media interface	High definition audio and video signal output port. It transmits uncompressed high definition video and multiple-channel data to the HDMI port of the display device.
10	AUDIO OUT	Audio output port	Connect to video output device such as sound box.
11		GND	Ground end

2.2.19 HCVR5104/5108/5116HE-S2 Series

The HCVR5104HE-S2 series rear panel is shown as below. See Figure 2-49.

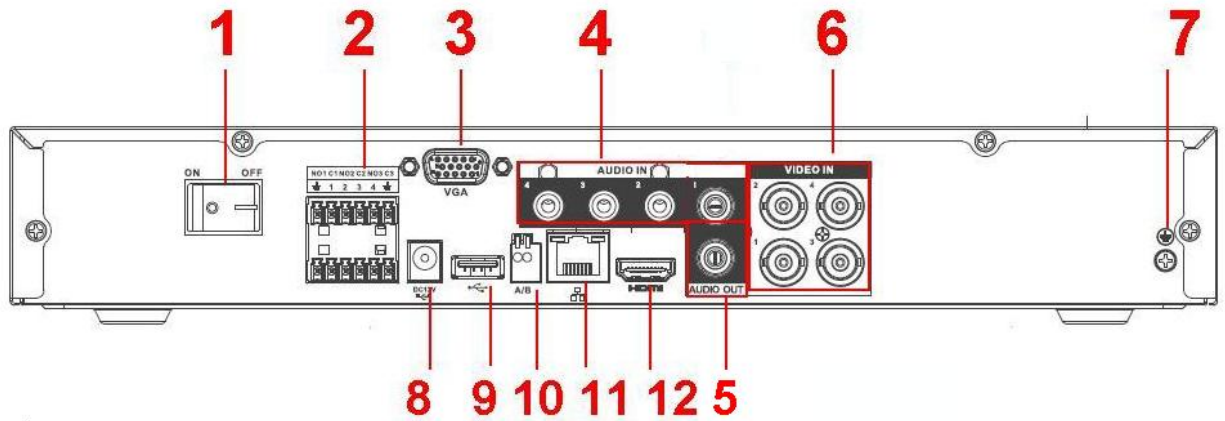

Figure 2-49

The HCVR5108HE-S2 series rear panel is shown as below. See Figure 2-50.

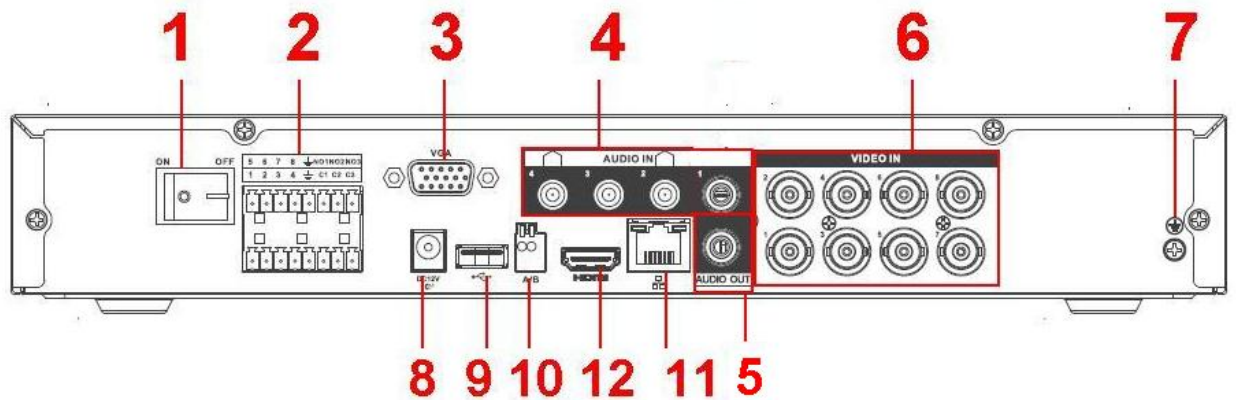

Figure 2-50

The HCVR5116HE-S2 series rear panel is shown as below. See Figure 2-51.

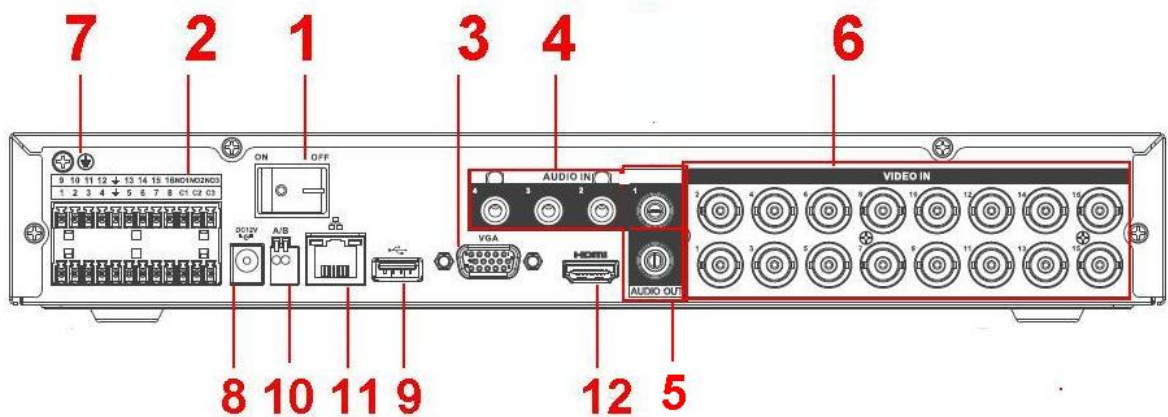

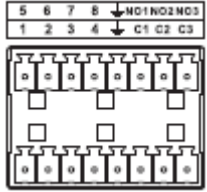





Figure 2-51

Please refer to the following sheet for detailed information.

SN	Icon	Name	Note
----	------	------	------

1		Power on-off button	Power on/off button.
2		Alarm input/Alarm output	Input/output alarm signal.
3	VGA	VGA video output port	VGA video output port. Output analog video signal. Can connect to the monitor to view analog video output.
4	AUDIO IN	Audio input port	Connect to audio input device such as speaker.
5	AUDIO OUT	Audio output port	Connect to video output device such as sound box.
6	VIDEO IN	Video input port	Connect to analog camera, video input signal.
7		GND	Ground end
8		Power input port	Input 12V DC.
9		USB2.0 port	Connect to USB storage device, mouse, burning DVD-ROM and etc.
10	A	RS485 (RS-485) communication port	RS485_A port. It is the cable A. You can connect to the control devices such as speed dome PTZ.
	B		RS485_B. It is the cable B. You can connect to the control devices such as speed dome PTZ.
11		Network port	100M Ethernet port
12	HDMI	High definition media interface	High definition audio and video signal output port. It transmits uncompressed high definition video and multiple-channel data to the HDMI port of the display device.

2.2.20 HCVR7104/7108H-S2 Series

The HCVR7104H-S2 series rear panel is shown as below. See Figure 2-52.

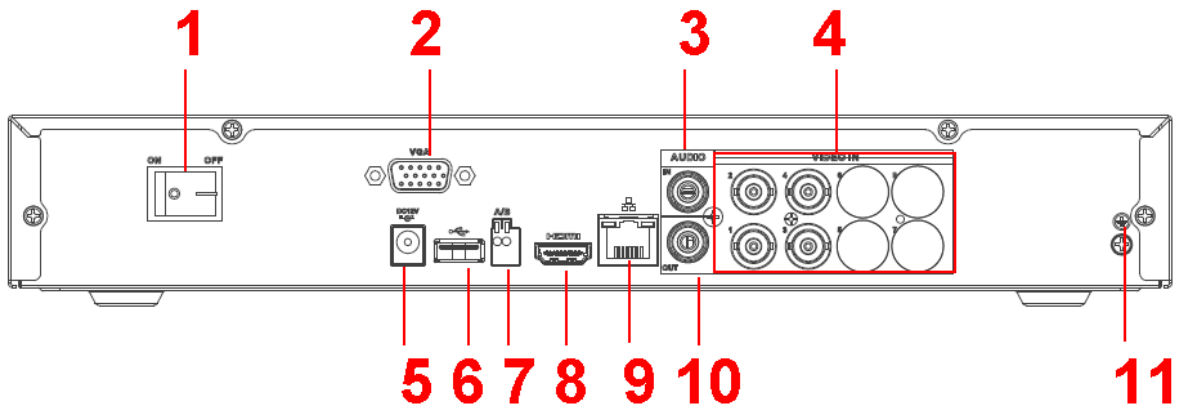

Figure 2-52

The HCVR7108H-S2 series rear panel is shown as below. See Figure 2-53.

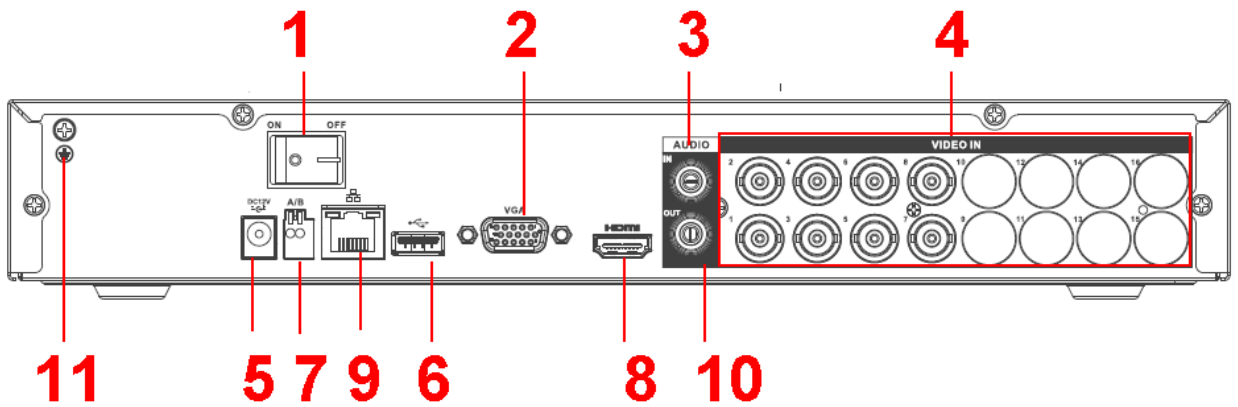
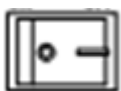





Figure 2-53

Please refer to the following sheet for detailed information.

SN	Icon	Name	Note
1		Power on-off button	Power on/off button.
2	VGA	VGA video output port	VGA video output port. Output analog video signal. Can connect to the monitor to view analog video output.
3	AUDIO IN	Audio input port	Connect to audio input device such as speaker.
4	VIDEO IN	Video input port	Connect to analog camera, video input signal.
5		Power input port	Input 12V DC.

6		USB2.0 port	Connect to USB storage device, mouse, burning DVD-ROM and etc.
7	A	RS485 (RS-485) communication port	RS485_A port. It is the cable A. You can connect to the control devices such as speed dome PTZ.
	B		RS485_B. It is the cable B. You can connect to the control devices such as speed dome PTZ.
8	HDMI	High definition media interface	High definition audio and video signal output port. It transmits uncompressed high definition video and multiple-channel data to the HDMI port of the display device.
9		Network port	100M Ethernet port
10	AUDIO OUT	Audio output port	Connect to video output device such as sound box.
11		GND	Ground end

2.2.21 HCVR7104/7108HE-S2 Series

The HCVR7104HE-S2 series rear panel is shown as below. See Figure 2-54.

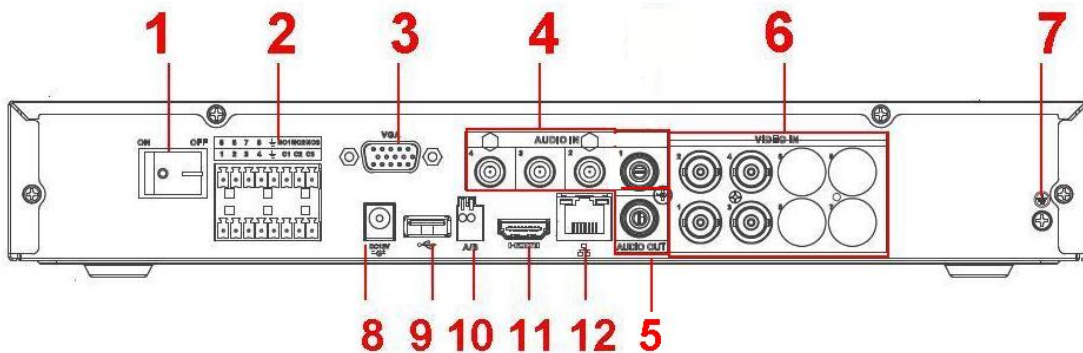

Figure 2-54

The HCVR7108HE-S2 series rear panel is shown as below. See Figure 2-55.

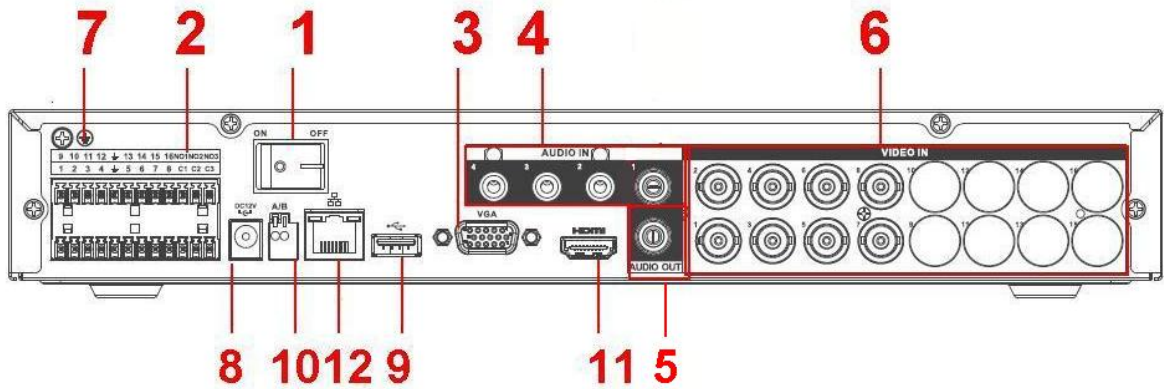



Figure 2-55

Please refer to the following sheet for detailed information.

SN	Icon	Name	Note
1		Power on-off button	Power on/off button.
2		Alarm input/Alarm output	Input/output alarm signal.
3	VGA	VGA video output port	VGA video output port. Output analog video signal. Can connect to the monitor to view analog video output.
4	AUDIO IN	Audio input port	Connect to audio input device such as speaker.
5	AUDIO OUT	Audio output port	Connect to video output device such as sound box.
6	VIDEO IN	Video input port	Connect to analog camera, video input signal.
7		GND	Ground end
8		Power input port	Input 12V DC.
9		USB2.0 port	Connect to USB storage device, mouse, burning DVD-ROM and etc.
10	A	RS485 (RS-485) communication port	RS485_A port. It is the cable A. You can connect to the control devices such as speed dome PTZ.
	B		RS485_B. It is the cable B. You

			can connect to the control devices such as speed dome PTZ.
11	HDMI	High definition media interface	High definition audio and video signal output port. It transmits uncompressed high definition video and multiple-channel data to the HDMI port of the display device.
12		Network port	100M Ethernet port

2.2.22 HCVR41XXHE-S3/HCVR51XXH-S3/HCVR71XXH-S3/HCVR71XXHE-S3 /XVR41XXHE/XVR51XXH/XVR51XXHE/XVR71XXH/XVR71XXHE/XVR51XXH-4M/ XVR51XXH-4KL/XVR71XXHE-4KL/ XVR51XXH-S2/ XVR51XXHE-S2 Series

The HCVR41XXHE-S3/HCVR51XXH-S3/HCVR51XXHE-S3/HCVR71XXHE-S3/XVR41XXHE/XVR51H/XVR51XXHE/XVR71XXHE/XVR51XXH-4M/XVR51XXH-4KL/XVR71XXHE-4KL series rear panel is shown as below. See Figure 2-56.

The following figure is based on HCVR4116HE-S3/HCVR5116HE-S3/HCVR7116HE-S3 /XVR4116HE/XVR5116HE/XVR7116HE series.

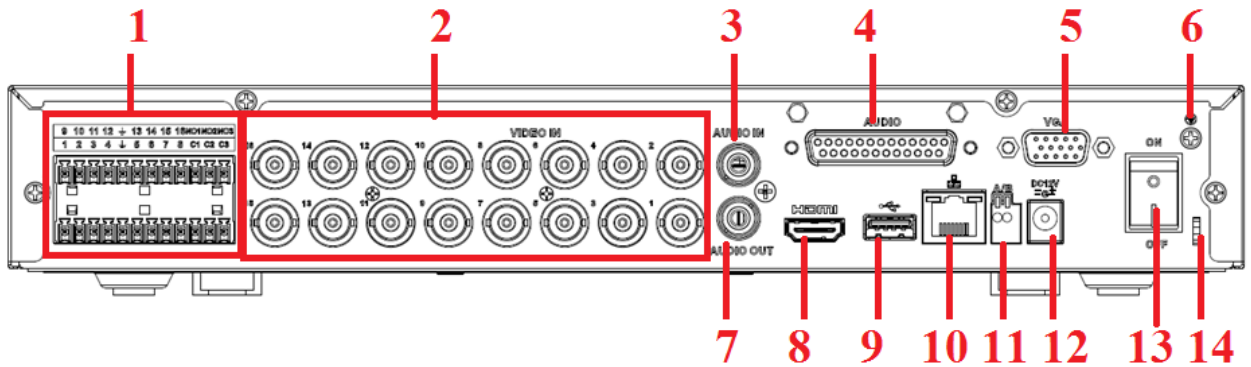

Figure 2-56

The HCVR71XXH-S3/XVR71XXH/XVR51XXH-S2/XVR51XXHE-S2 rear panel is shown as below. See Figure 2-57.

The following figure is based on the HCVR7116H-S3/XVR7116H/XVR51XXH-S2/XVR51XXHE-S2.

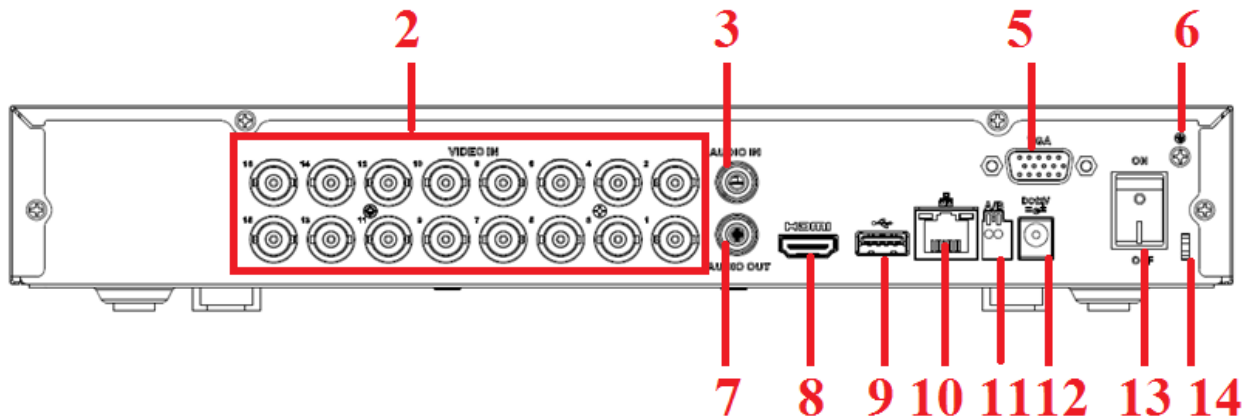





Figure 2-57

Please refer to the following sheet for detailed information.

SN	Icon	Name	Note
1		Alarm input/Alarm output	Input/output alarm signal.
2	VIDEO IN	Video input port	Connect to analog camera, video input signal.
3	AUDIO IN	Audio input port	Connect to audio input device such as speaker.
4		DB25 port	The 5th to the 16th-channel audio input port.
5	VGA	VGA video output port	VGA video output port. Output analog video signal. Can connect to the monitor to view analog video output.
6		GND	Ground end
7	AUDIO OUT	Audio output port	Connect to video output device such as sound box.
8	HDMI	High definition media interface	High definition audio and video signal output port. It transmits uncompressed high definition video and multiple-channel data to the HDMI port of the display device.
9		USB2.0 port	Connect to USB storage device, mouse, burning DVD-ROM and etc.

10		Network port	100M Ethernet port
11	A	RS485 (RS-485) communication port	RS485_A port. It is the cable A. You can connect to the control devices such as speed dome PTZ.
	B		RS485_B. It is the cable B. You can connect to the control devices such as speed dome PTZ.
12		Power input port	Input 12V DC.
13		Power on-off button	Power on/off button.
14		Power cable fastener	Use clamp to secure the power cable on the device in case there is any loss.

2.2.23 HCVR41XXHS-S2/ HCVR2108HS-S2/ HCVR2116HS-S2 Series

The HCVR4104HS-S2 series rear panel is shown as below. See Figure 2-58.

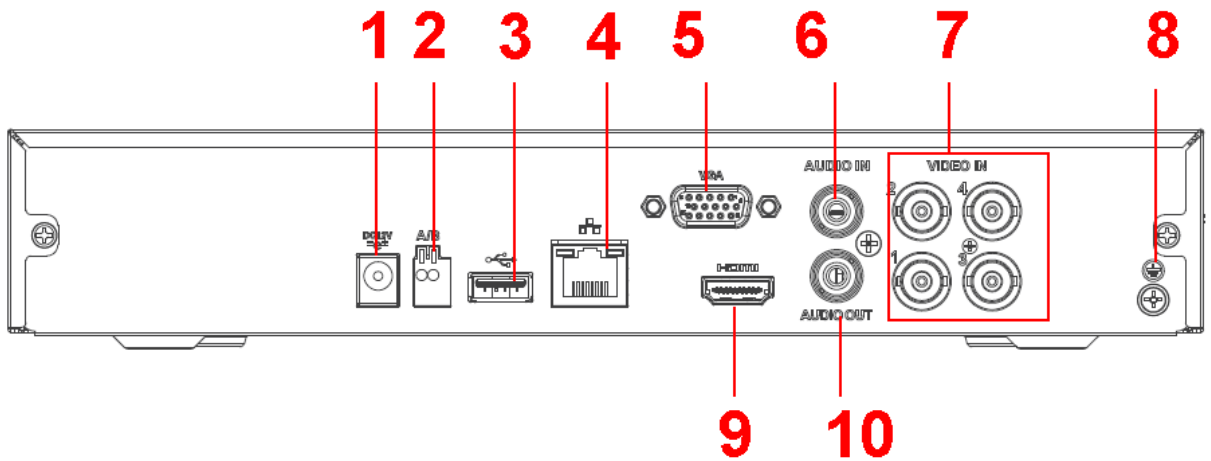

Figure 2-58

The HCVR4108HS-S2/HCVR2108HS-S2 series rear panel is shown as below. See Figure 2-59.

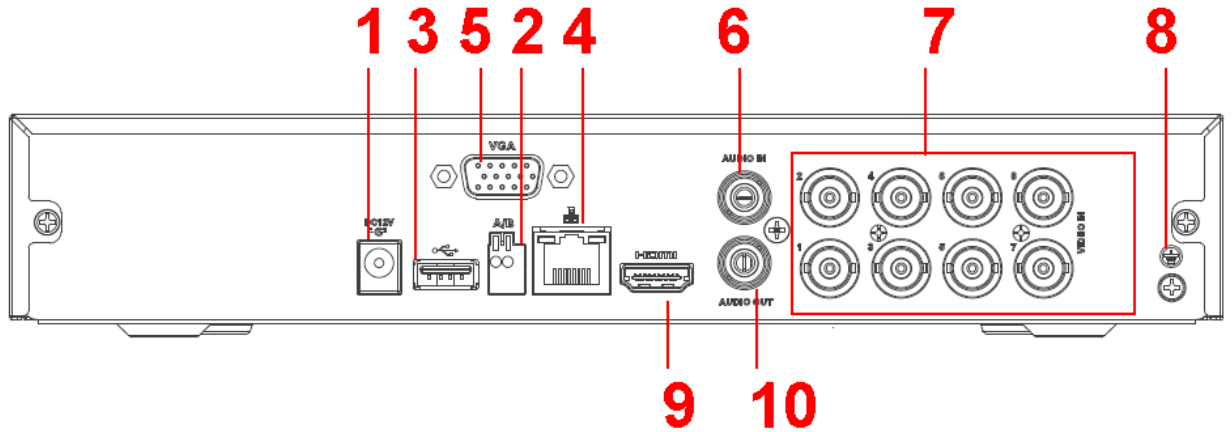

Figure 2-59

The HCVR4116HS-S2/ HCVR2116HS-S2 series rear panel is shown as below. See Figure 2-60.

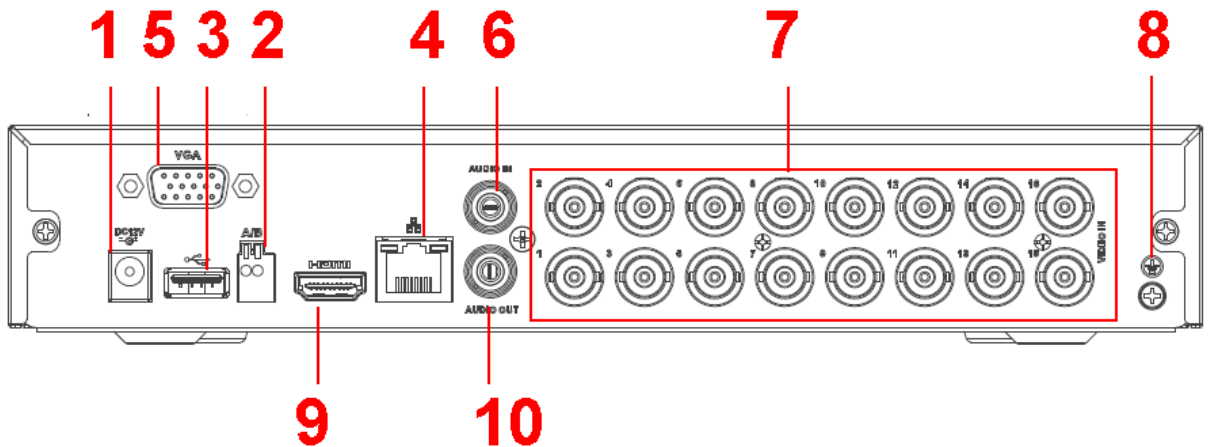



Figure 2-60

Please refer to the following sheet for detailed information.

SN	Icon	Name	Note
1	DC 12V ⊖ ⊕	Power input port	Input 12V DC.
2	A	RS485 (RS-485) communication port	RS485_A port. It is the cable A. You can connect to the control devices such as speed dome PTZ.
	B		RS485_B.It is the cable B. You can connect to the control devices such as speed dome PTZ.
3	USB	USB2.0 port	Connect to USB storage device, mouse, burning DVD-ROM and etc.

4		Network port	100M Ethernet port
5	VGA	VGA video output port	VGA video output port. Output analog video signal. Can connect to the monitor to view analog video output.
6	AUDIO IN	Audio input port	Connect to audio input device such as speaker.
7	VIDEO IN	Video input port	Connect to analog camera, video input signal.
8		GND	Ground end
9	HDMI	High definition media interface	High definition audio and video signal output port. It transmits uncompressed high definition video and multiple-channel data to the HDMI port of the display device.
10	AUDIO OUT	Audio output port	Connect to video output device such as sound box.

**2.2.24 HCVR21XXHS-S3/HCVR41XXHS-S3/HCVR51XXHS-S3/HCVR7104HS-S3
/XVR21XXHS/XVR41XXHS/XVR51XXHS/XVR7104HS/XVR51XXHS-4M/XVR51XXHS-4KL/ XVR41XXHS-S2/ XVR51XXHS-S2 Series**

The HCVR2116HS-S3/HCVR41XXHS-S3/51XXHS-S3/XVR2116HS/XVR41XXHS/XVR51XXHS/ XVR51XXHS-4M/XVR51XXHS-4KL series rear panel is shown as below. See Figure 2-61.

The following figure is based on the HCVR2116HS-S3/HCVR4116HS-S3/5116HS-S3 /XVR2116HS/XVR4116HS/XVR5116HS series product.

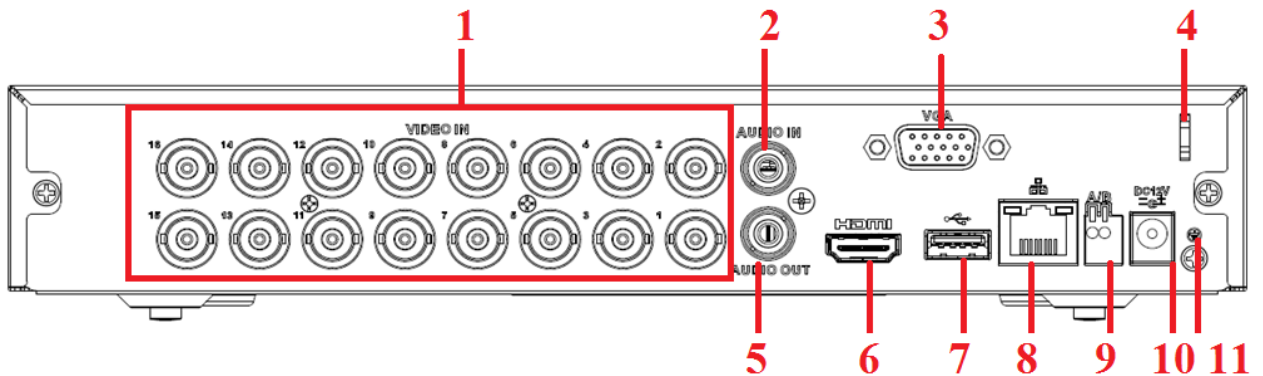

Figure 2-61

The HCVR7104HS-S3/XVR7104HS/XVR41XXHS-S2/XVR51XXHS-S2 series rear panel

is shown as below. See Figure 2-62.

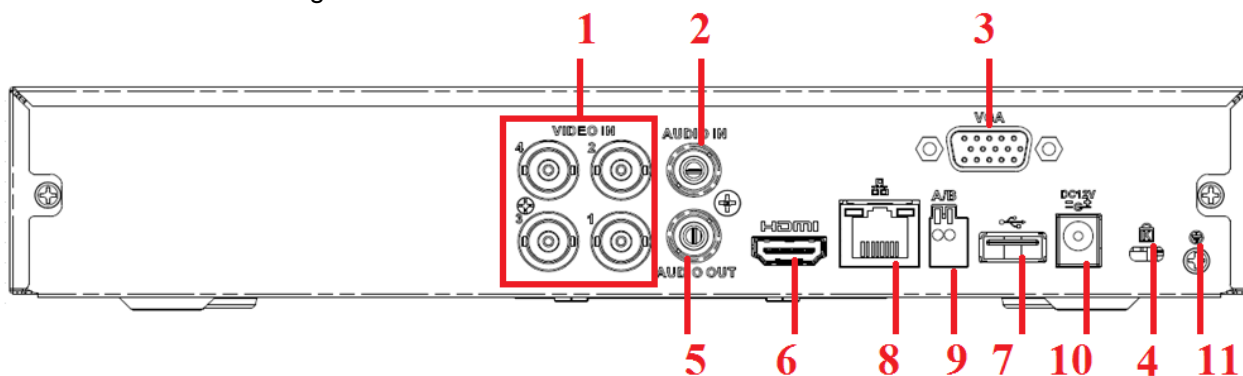





Figure 2-62

Please refer to the following sheet for detailed information.

SN	Icon	Name	Note
1	VIDEO IN	Video input port	Connect to analog camera, video input signal.
2	AUDIO IN	Audio input port	Connect to audio input device such as speaker.
3	VGA	VGA video output port	VGA video output port. Output analog video signal. Can connect to the monitor to view analog video output.
4		Power cable fastener	Use clamp to secure the power cable on the device in case there is any loss.
5	AUDIO OUT	Audio output port	Connect to video output device such as sound box.
6	HDMI	High definition media interface	High definition audio and video signal output port. It transmits uncompressed high definition video and multiple-channel data to the HDMI port of the display device.
7		USB2.0 port	Connect to USB storage device, mouse, burning DVD-ROM and etc.
8		Network port	100M Ethernet port
9	A	RS485 (RS-485) communication port	RS485_A port. It is the cable A. You can connect to the control devices such as speed dome PTZ.
	B		RS485_B.It is the cable B. You can connect to the control

			devices such as speed dome PTZ.
10	DC 12V =G±	Power input port	Input 12V DC.
11	⏏	GND	Ground end

2.2.25 HCVR52XXA-V2/ HCVR72XXA-V2 Series

This series products' rear panel is shown as below. See Figure 2-63.

The following figure is based on HCVR7204A-V2 series product.

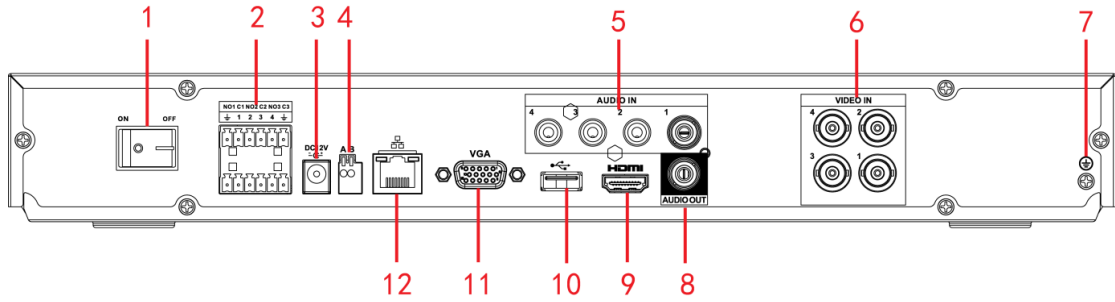





Figure 2-63

Please refer to the following sheet for detailed information.

SN	Icon	Name	Note
1		Power switch	Power on/off button.
2	1~4	Alarm input port 1~4	<ul style="list-style-type: none"> There are two types; NO (normal open)/NC (normal close). When your alarm input device is using external power, please make sure the device and the DVR have the same ground.
	NO1~NO3	Alarm output port 1~3	<ul style="list-style-type: none"> 3 groups of alarm output ports. (Group 1:port NO1~C1,Group 2:port NO2~C2,Group 3:port NO3~C3).Output alarm signal to the alarm device. Please make sure there is power to the external alarm device. NO:Normal open alarm output port. C:Alarm output public end.
	C1~C3		
3	DC 12V =G±	Power input port	Input DC 12V/5A.
4	AB	RS-485 communication port	<ul style="list-style-type: none"> RS485_A port. It is the cable A. You can connect to the control devices such as speed dome PTZ. RS485_B.It is the cable B. You can connect to the control devices such as speed dome PTZ.
5	AUDIO IN	Audio input port	It is to receive the analog audio signal output from the devices such as mike phone, pickup.

SN	Icon	Name	Note
6	VIDEO IN	Video input port	Connect to analog camera to input video signal.
7		GND	Alarm input ground port.
8	AUDIO OUT	Audio output port	Audio output port. It is to output the analog audio signal to the devices such as the sound box.
9	HDMI	High Definition Media Interface	High definition audio and video signal output port. It transmits uncompressed high definition video and multiple-channel data to the HDMI port of the display device.
10		USB2.0 port	USB2.0 port. Connect to mouse, USB storage device, USB burner and etc.
11	VGA	VGA video output port	VGA video output port. Output analog video signal. It can connect to the monitor to view analog video.
12		Network port	1000M Ethernet port

2.2.26 HCVR42XXA-S2/ HCVR4216AN-S2 Series

This HCVR4204A-S2 rear panel is shown as below. See Figure 2-64.

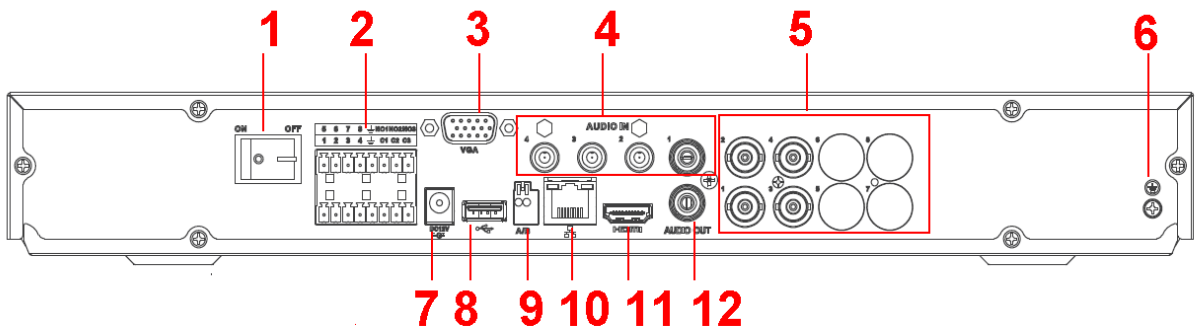

Figure 2-64

This HCVR4208A-S2 rear panel is shown as below. See Figure 2-65.

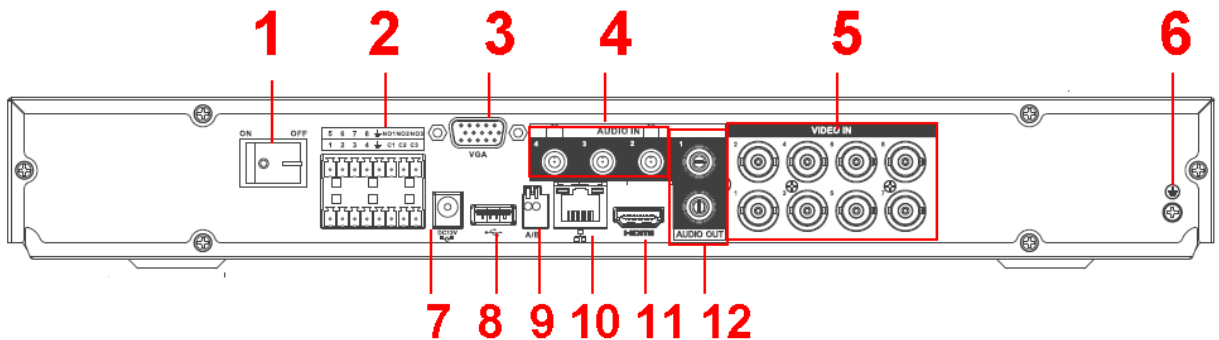

Figure 2-65

This HCVR4216A-S2 rear panel is shown as below. See Figure 2-66.

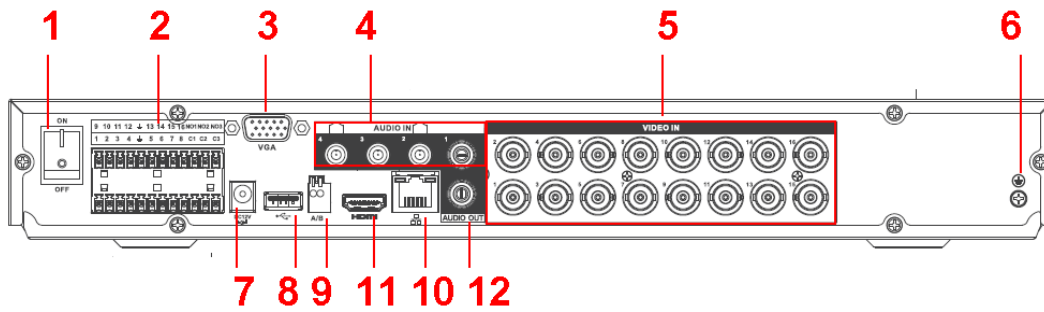

Figure 2-66

This HCVR4216AN-S2 rear panel is shown as below. See Figure 2-67.

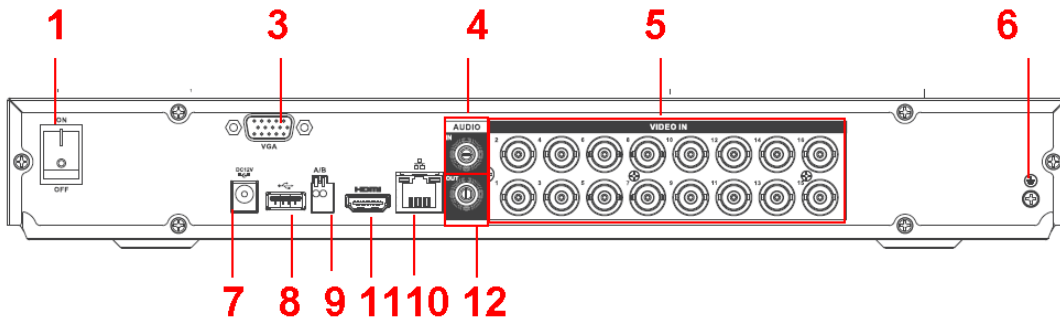
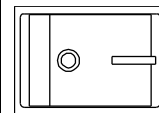





Figure 2-67

Please refer to the following sheet for detailed information.

SN	Icon	Name	Note
1		Power switch	Power on/off button.
2	1~8(16)	Alarm input port 1~8(16)	<ul style="list-style-type: none"> There are two types; NO (normal open)/NC (normal close). When your alarm input device is using external power, please make sure the device and the DVR have the same ground.
	NO1~NO3	Alarm output port 1~3	<ul style="list-style-type: none"> 3 groups of alarm output ports. (Group 1:port NO1~C1,Group 2:port NO2~C2,Group 3:port NO3~C3).Output alarm signal to the alarm device. Please make sure there is power to the external alarm device. NO:Normal open alarm output port. C:Alarm output public end.
	C1~C3		
3	VGA	VGA video output port	VGA video output port. Output analog video signal. Can connect to the monitor to view analog video output.

SN	Icon	Name	Note
4	AUDIO IN	Audio input port	Connect to audio input device such as speaker.
5	VIDEO IN	Video input port	Connect to analog camera, video input signal.
6		GND	Alarm input ground port.
7		Power input port	Input 12V DC.
8		USB2.0 port	Connect to USB storage device, mouse, burning DVD-ROM and etc.
9	A	RS485 (RS-485) communication port	RS485_A port. It is the cable A. You can connect to the control devices such as speed dome PTZ. RS485_B.It is the cable B. You can connect to the control devices such as speed dome PTZ.
	B		
10		Network port	1000M Ethernet port
11	HDMI	High Definition Media Interface	High definition audio and video signal output port. It transmits uncompressed high definition video and multiple-channel data to the HDMI port of the display device.
12	AUDIO OUT	Audio output port	Connect to video output device such as sound box.

2.2.27 HCVR4224/HCVR4232AN-S2 Series

The rear panel is shown as below. See Figure 2-68.

The following figure is based on the HCVR4232AN-V2 series product.

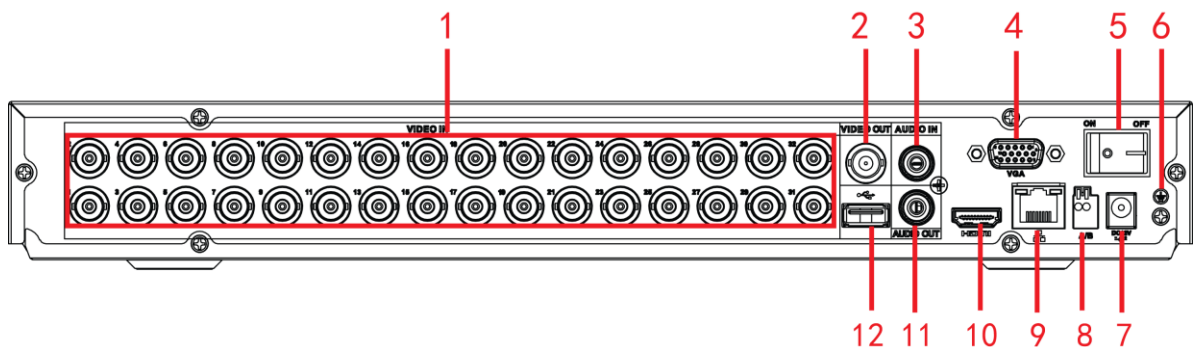
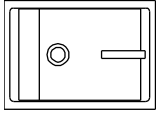





Figure 2-68

Please refer to the following sheet for detailed information.

SN	Icon	Name	Note
1	VIDEO IN	Video input port	Connect to analog camera, video input signal.
2	VIDEO OUT	Video output	Connect to output devices such as TV.

SN	Icon	Name	Note
		port	
3	AUDIO IN	Audio input port	Connect to audio input device such as speaker.
4	VGA	VGA video output port	VGA video output port. Output analog video signal. Can connect to the monitor to view analog video output.
5		Power switch	Power on/off button.
6		GND	Alarm input ground port.
7	DC12V 	Power input port	Input 12V/5A DC.
8	A	RS485 (RS-485) communication port	RS485_A port. It is the cable A. You can connect to the control devices such as speed dome PTZ.
	B		RS485_B. It is the cable B. You can connect to the control devices such as speed dome PTZ.
9		Network port	1000M Ethernet port
10	HDMI	High Definition Media Interface	High definition audio and video signal output port. It transmits uncompressed high definition video and multiple-channel data to the HDMI port of the display device.
11	AUDIO OUT	Audio output port	Connect to video output device such as sound box.
12		USB2.0 port	USB2.0 port. Connect to mouse, USB storage device, USB burner and etc.

2.2.28 HCVR52XXA-S2/ HCVR5216AN-S2 Series

This HCVR5204A-S2 products' rear panel is shown as below. See Figure 2-69.

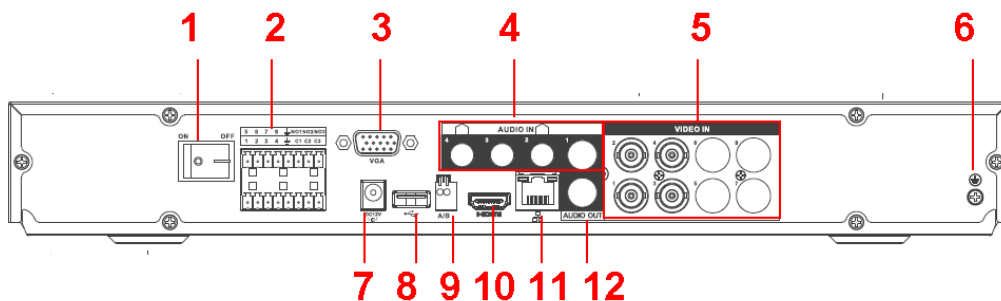

Figure 2-69

This HCVR5208A-S2 products' rear panel is shown as below. See Figure 2-70.

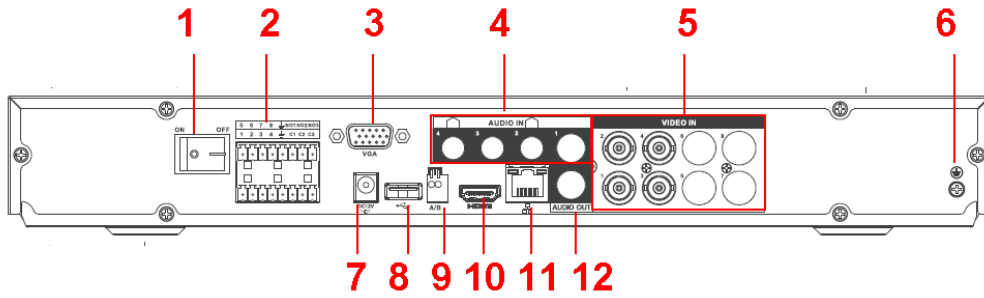

Figure 2-70

This HCVR5216A-S2 products' rear panel is shown as below. See Figure 2-71.

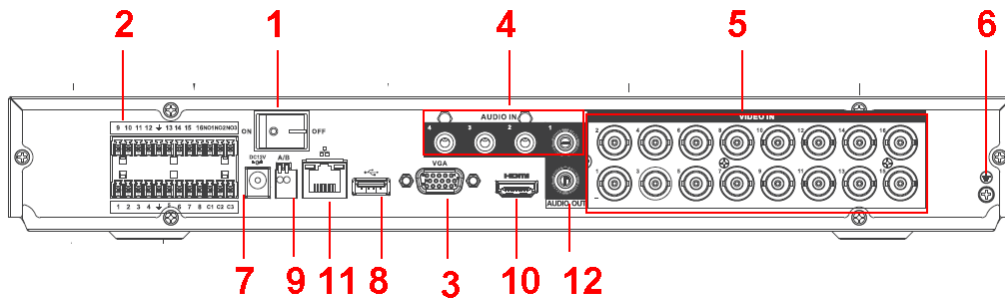

Figure 2-71

This HCVR5216AN-S2 products' rear panel is shown as below. See Figure 2-72.

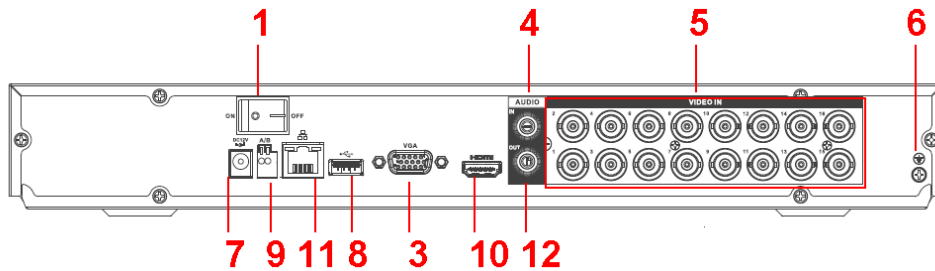





Figure 2-72

Please refer to the following sheet for detailed information.

SN	Icon	Name	Note
1		Power switch	Power on/off button.
2	1~8(16)	Alarm input port 1~8(16)	<ul style="list-style-type: none"> There are two types; NO (normal open)/NC (normal close). When your alarm input device is using external power, please make sure the device and the DVR have the same ground.

SN	Icon	Name	Note
	NO1~NO3	Alarm output port 1~3	<ul style="list-style-type: none"> ● 3 groups of alarm output ports. (Group 1:port NO1~C1,Group 2:port NO2~C2,Group 3:port NO3~C3).Output alarm signal to the alarm device. Please make sure there is power to the external alarm device. ● NO:Normal open alarm output port. ● C:Alarm output public end.
	C1~C3		
3	VGA	VGA video output port	VGA video output port. Output analog video signal. Can connect to the monitor to view analog video output.
4	AUDIO IN	Audio input port	Connect to audio input device such as speaker.
5	VIDEO IN	Video input port	Connect to analog camera, video input signal.
6		GND	Alarm input ground port.
7		Power input port	Input 12V DC.
8		USB2.0 port	Connect to USB storage device, mouse, burning DVD-ROM and etc.
9	A	RS485 (RS-485) communication port	RS485_A port. It is the cable A. You can connect to the control devices such as speed dome PTZ. RS485_B.It is the cable B. You can connect to the control devices such as speed dome PTZ.
	B		
10	HDMI	High Definition Media Interface	High definition audio and video signal output port. It transmits uncompressed high definition video and multiple-channel data to the HDMI port of the display device.
11		Network port	100M Ethernet port
12	AUDIO OUT	Audio output port	Connect to video output device such as sound box.

2.2.29 HCVR720XA-S2 Series

The HCVR7204A-S2 products' rear panel is shown as below. See Figure 2-73.

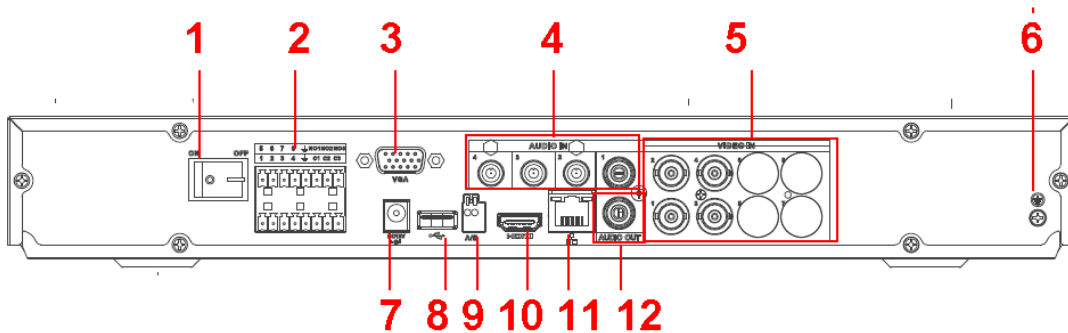

Figure 2-73

The HCVR7208A-S2 products' rear panel is shown as below. See Figure 2-74.

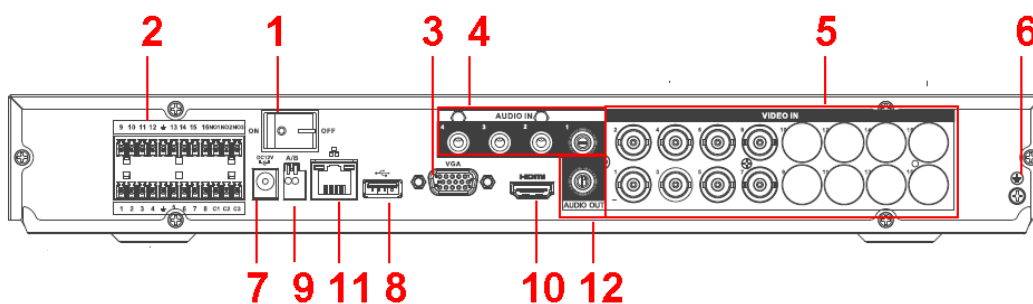
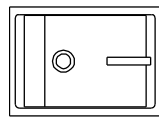





Figure 2-74

Please refer to the following sheet for detailed information.

SN	Icon	Name	Note
1		Power switch	Power on/off button.
2	1~8(16)	Alarm input port 1~8(16)	<ul style="list-style-type: none"> There are two types; NO (normal open)/NC (normal close). When your alarm input device is using external power, please make sure the device and the DVR have the same ground.
	NO1~NO3 C1~C3	Alarm output port 1~3	<ul style="list-style-type: none"> 3 groups of alarm output ports. (Group 1:port NO1~C1,Group 2:port NO2~C2,Group 3:port NO3~C3).Output alarm signal to the alarm device. Please make sure there is power to the external alarm device. NO:Normal open alarm output port. C:Alarm output public end.
3	VGA	VGA video output port	VGA video output port. Output analog video signal. Can connect to the monitor to view analog video output.
4	AUDIO IN	Audio input port	Connect to audio input device such as speaker.

SN	Icon	Name	Note
5	VIDEO IN	Video input port	Connect to analog camera, video input signal.
6		GND	Alarm input ground port.
7		Power input port	Input 12V DC.
8		USB2.0 port	Connect to USB storage device, mouse, burning DVD-ROM and etc.
9	A B	RS485 (RS-485) communication port	RS485_A port. It is the cable A. You can connect to the control devices such as speed dome PTZ. RS485_B.It is the cable B. You can connect to the control devices such as speed dome PTZ.
10	HDMI	High Definition Media Interface	High definition audio and video signal output port. It transmits uncompressed high definition video and multiple-channel data to the HDMI port of the display device.
11		Network port	100M Ethernet port
12	AUDIO OUT	Audio output port	Connect to video output device such as sound box.

2.2.30 HCVR42XXA-S3/HCVR42XXAN-S3/HCVR52XXA-S3/HCVR52XXAN-S3/HCVR72XXA-S3/HCVR7216AN-S3/XVR42XXA/XVR42XXAN/XVR52XXA/XVR52XXAN/XVR72XXA/XVR7216AN/XVR52XXAN-4M/XVR52XXAN-4K/XVR72XXA-4K/XVR72XXA-4K/XVR72XXA-4K/XVR72XXA-4K/XVR42XXA-S2/ XVR42XXAN-S2/ XVR52XXA-S2/ XVR52XXAN-S2 Series

The HCVR42XXA-S3/HCVR52XXA-S3/HCVR72XXA-S3/XVR42XXA/XVR52XXA/XVR72XXA/XVR52XXAN-4M/XVR52XXAN-4KL/XVR72XXA-4K/XVR72XXA-4K/XVR72XXA-4KL/XVR72XXA-4K/XVR42XXA-S2/XVR42XXAN-S2/XVR52XXA-S2/XVR52XXAN-S2 products' rear panel is shown as below. See Figure 2-75.

The following figure is based on the HCVR4216A-S3/5216A-S3/7216A-S3/XVR4216A/XVR5216A/XVR7216A/XVR42XXA-S2/XVR42XXAN-S2/XVR52XXA-S2/XVR52XXAN-S2 series product.

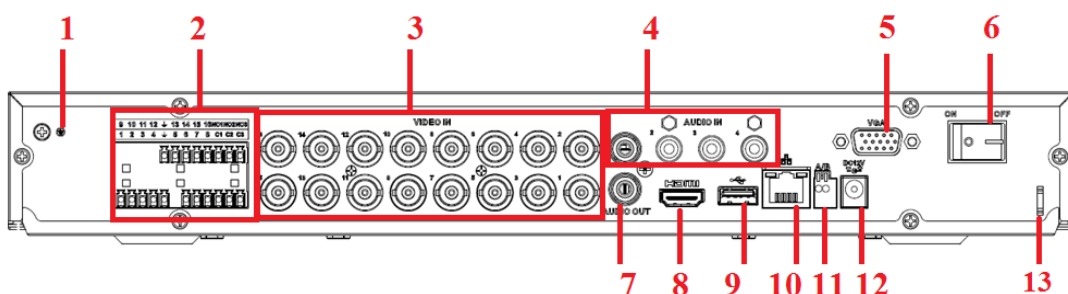

Figure 2-75

The HCVR42XXAN-S3/52XXAN-S3/7216AN-S3/XVR4216AN/5216AN/7216AN/
XVR5204AN-4M/XVR52XXAN-4M/XVR52XXAN-4KL rear panel is shown as below. See
Figure 2-76.

The following figure is based on the

HCVR4216AN-S3/5216AN-S3/XVR4216AN/XVR5216AN series product.

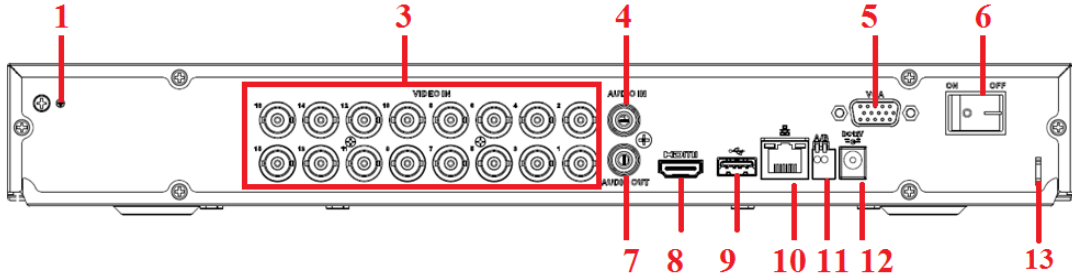

Figure 2-76

The XVR4232AN/5232AN rear panel is shown as below. See Figure 2-77.

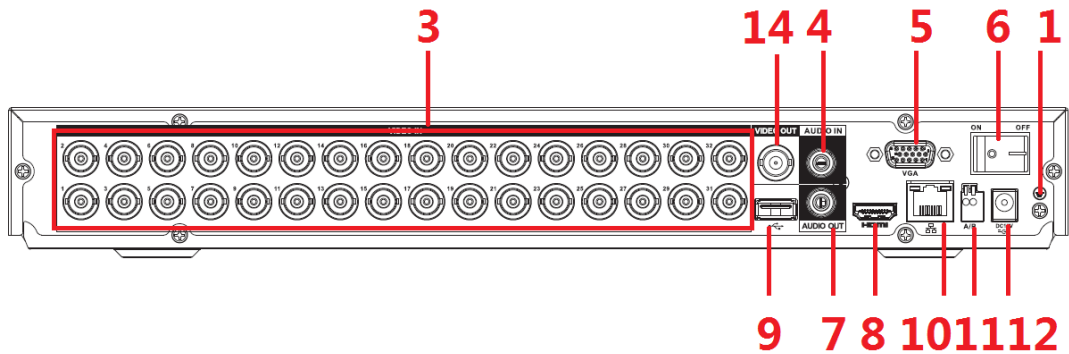
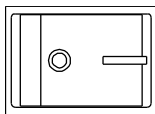





Figure 2-77

Please refer to the following sheet for detailed information.

SN	Icon	Name	Note
1		GND	Alarm input ground port.
2	1~8(16)	Alarm input port 1~8(16)	<ul style="list-style-type: none"> There are two types; NO (normal open)/NC (normal close). When your alarm input device is using external power, please make sure the device and the DVR have the same ground.
	NO1~NO3	Alarm output port 1~3	<ul style="list-style-type: none"> 3 groups of alarm output ports. (Group 1:port NO1~C1,Group 2:port NO2~C2,Group 3:port NO3~C3).Output alarm signal to the alarm device. Please make sure there is power to the external alarm device. NO:Normal open alarm output port.

SN	Icon	Name	Note
	C1~C3		● C:Alarm output public end.
3	VIDEO IN	Video input port	Connect to analog camera, video input signal.
4	AUDIO IN	Audio input port	Connect to audio input device such as speaker.
5	VGA	VGA video output port	VGA video output port. Output analog video signal. Can connect to the monitor to view analog video output.
6		Power switch	Power on/off button.
7	AUDIO OUT	Audio output port	Connect to video output device such as sound box.
8	HDMI	High Definition Media Interface	High definition audio and video signal output port. It transmits uncompressed high definition video and multiple-channel data to the HDMI port of the display device.
9		USB port	Connect to USB storage device, mouse, burning DVD-ROM and etc.
10		Network port	100 or 1000M Ethernet port
11	A	RS485 (RS-485) communication port	RS485_A port. It is the cable A. You can connect to the control devices such as speed dome PTZ.
	B		RS485_B.It is the cable B. You can connect to the control devices such as speed dome PTZ.
12		Power input port	Input 12V DC.
13		Power cable fastener	Use clamp to secure the power cable on the device in case there is any loss.
14	VIDEO OUT	Video output port	Connect to output devices such as TV.

2.2.31 HCVR52XXL-V2/ HCVR54XXL-V2/HCVR44L-S2 Series

This series products' rear panel is shown as below. See Figure 2-78.

The following figure is based on the HCVR5416L-V2 series product.

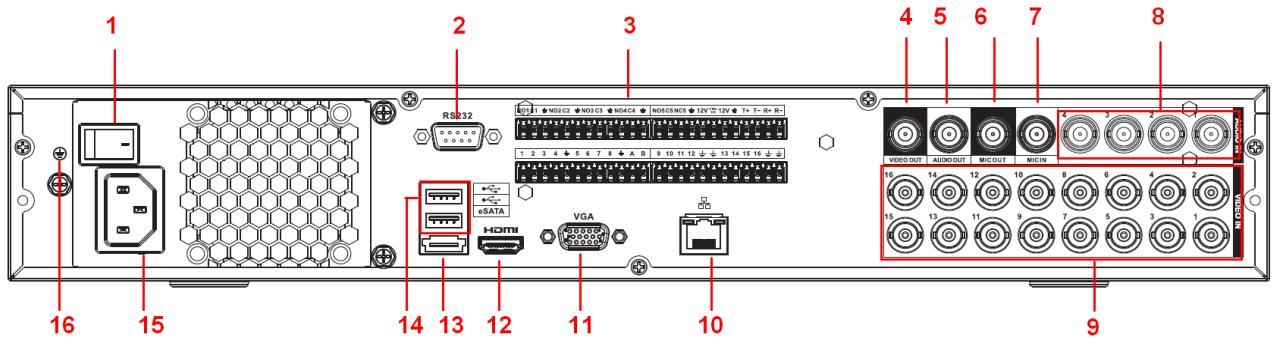

Figure 2-78

The HCVR4432L-S2 rear panel is shown as below. See Figure 2-79.

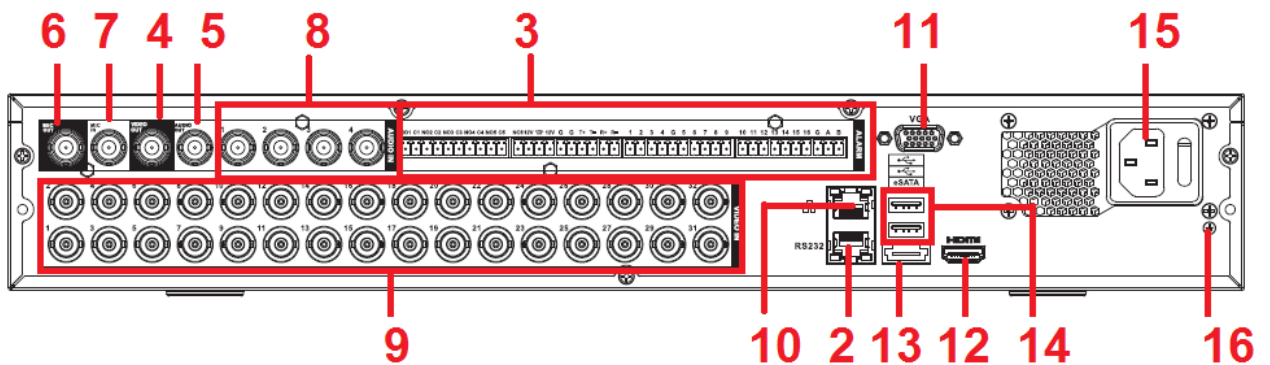







Figure 2-79

Please refer to the following sheet for detailed information.

SN	Icon	Name	Note
1		Power switch	Power on/off button.
2	RS-232	RS-232 debug COM.	It is for general COM debug to configure IP address or transfer transparent COM data.
3	1~16	Alarm input port 1~16	<ul style="list-style-type: none"> There are four groups. The first group is from port 1 to port 4, the second group is from port 5 to port 8, the third group is from 9 to 12, and the fourth group is from 13 to 16. They are to receive the signal from the external alarm source. There are two types; NO (normal open)/NC (normal close). When your alarm input

SN	Icon	Name	Note
			device is using external power, please make sure the device and the DVR have the same ground.
	NO1~NO5 C1~C5 NC5	Alarm output port 1~5	<ul style="list-style-type: none"> ● 5 groups of alarm output ports. (Group 1:port NO1 ~ C1,Group 2:port NO2 ~ C2,Group 3:port NO3~C3, Group 4:port NO4~C4, Group 5: port NO5, C5, NC5).Output alarm signal to the alarm device. Please make sure there is power to the external alarm device. ● NO: Normal open alarm output port. ● C: Alarm output public end. ● NC: Normal close alarm output port.
	A	RS-485 communication port	RS485_A port. It is the cable A. You can connect to the control devices such as speed dome PTZ.
	B		RS485_B.It is the cable B. You can connect to the control devices such as speed dome PTZ.
	T+, T-, R+, R-	Four-wire full-duplex 485 port	Four-wire full-duplex 485 port. T+,T- is the output wire. R+,R- is the input wire.
	CTRL 12V	Control power output	Controller 12V power output. It is to control the on-off alarm relay output.
4	VIDEO OUT	Video output port	Connect to video output devices such as TV.
5	AUDIO OUT	Audio output port	Audio output port. It is to output the analog audio signal

SN	Icon	Name	Note
			to the devices such as the sound box.
6	MIC OUT	Audio output port	<p>Audio output port. It is to output the analog audio signal to the devices such as the sound box.</p> <ul style="list-style-type: none"> ● Bidirectional talk output. ● Audio output on 1-window video monitor. ● Audio output on 1-window video playback.
7	MIC IN	Audio input port	Bidirectional talk input port. It is to receive the analog audio signal output from the devices such as mike phone, pickup.
8	AUDIO IN	Audio input port	It is to receive the analog audio signal output from the devices such as mike phone, pickup.
9	VIDEO IN	Video input port	Connect to analog camera to input video signal.
10		Network port	1000M Ethernet port
11	VGA	VGA video output port	VGA video output port. Output analog video signal. It can connect to the monitor to view analog video.
12	HDMI	High Definition Media Interface	High definition audio and video signal output port. It transmits uncompressed high definition video and multiple-channel data to the HDMI port of the display device.
13	eSATA	eSATA port	External SATA port. It can connect to the device of the SATA port. Please jump the HDD when there is peripheral connected HDD.
14		USB2.0 port	USB2.0 port. Connect to mouse, USB storage device, USB burner and etc.

SN	Icon	Name	Note
15		Power socket	Power socket
16		GND	GND

2.2.32 HCVR42XXL-S2 Series

The rear panel is shown as in Figure 2-80

The following figure is based on the HCVR4232L-V2 series product.

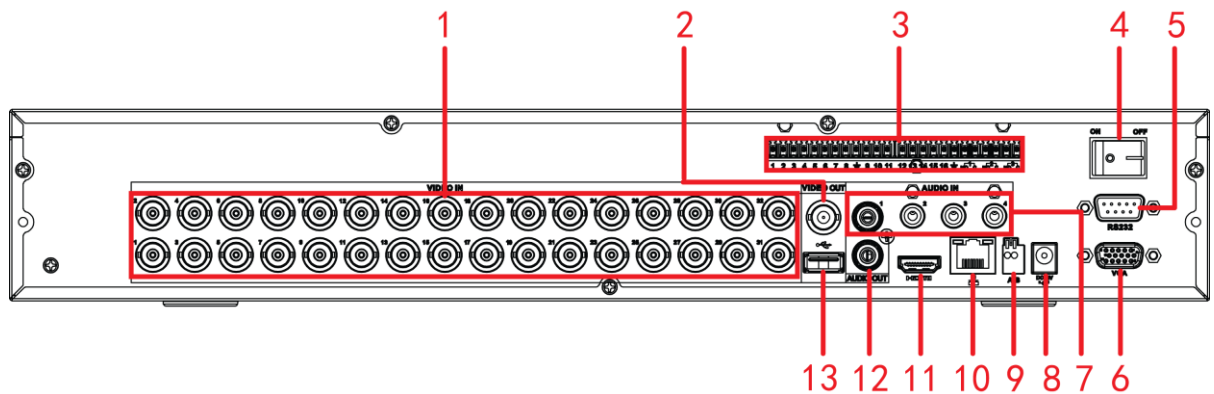

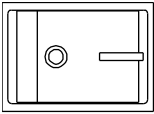



Figure 2-80

Please refer to the following sheet for detailed information.

SN	Icon	Name	Note
1	VIDEO IN	Video input port	Connect to analog camera, video input signal.
2	VIDEO OUT	Video output port	Connect to output devices such as TV.
3	1~16	Alarm input port 1~16	<ul style="list-style-type: none"> There are four groups. The first group is from port 1 to port 4, the second group is from port 5 to port 8, the third group is from 9 to 12, and the fourth group is from 13 to 16. They are to receive the signal from the external alarm source. There are two types; NO (normal open)/NC (normal close). When your alarm input device is using external power, please make sure the device and the DVR have the same ground.
	NO1~NO3	Alarm output port 1~3	<ul style="list-style-type: none"> 3 groups of alarm output ports. (Group 1:port NO1~C1,Group 2:port NO2~C2,Group 3:port NO3~C3).Output alarm signal to the alarm device. Please make sure there is power to the external alarm device. NO:Normal open alarm output port.

SN	Icon	Name	Note
	C1~C3		● C:Alarm output public end.
		GND	Alarm input ground port.
4		Power switch	Power on/off button.
5	RS-232	RS-232 debug COM.	It is for general COM debug to configure IP address or transfer transparent COM data.
6	VGA	VGA video output port	VGA video output port. Output analog video signal. Can connect to the monitor to view analog video output.
7	AUDIO IN	Audio input port	Connect to audio input device such as speaker.
8	DC12V =G±	Power input port	Input 12V/5A DC.
9	A	RS-485 communication port	RS485_A port. It is the cable A. You can connect to the control devices such as speed dome PTZ.
	B		RS485_B.It is the cable B. You can connect to the control devices such as speed dome PTZ.
10		Network port	1000M Ethernet port
11	HDMI	High Definition Media Interface	High definition audio and video signal output port. It transmits uncompressed high definition video and multiple-channel data to the HDMI port of the display device.
12	AUDIO OUT	Audio output port	Audio output port. It is to output the analog audio signal to the devices such as the sound box.
13		USB2.0 port	USB2.0 port. Connect to mouse, USB storage device, USB burner and etc.

2.2.33 HCVR58XXS-V2/HCVR48XXS-S2 Series

The rear panel is shown as in Figure 2-81.

The following figure is based on the HCVR5816S-V2 series product.

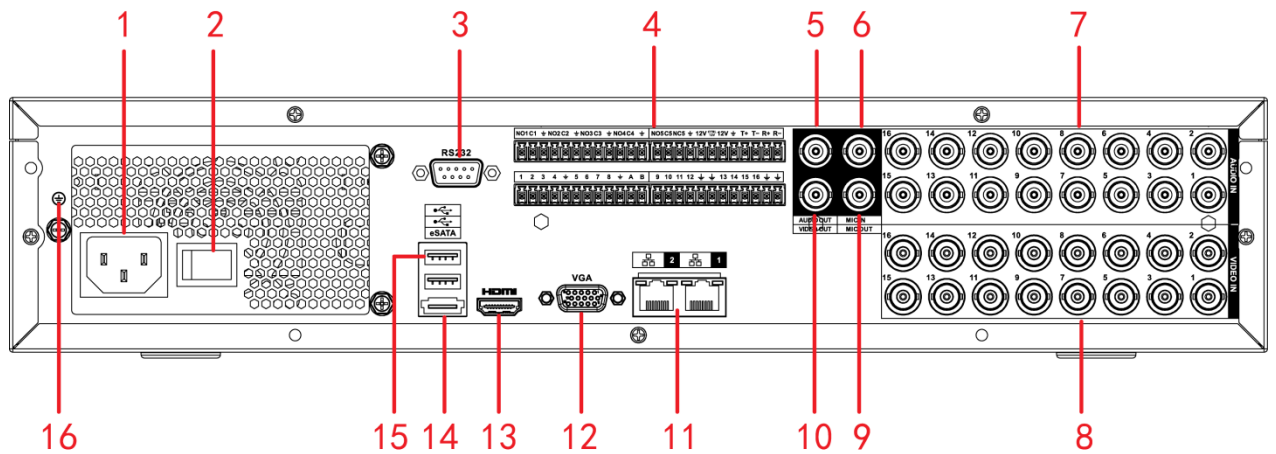

Figure 2-81

The HCVR4832S-S2 rear panel is shown as in Figure 2-82.

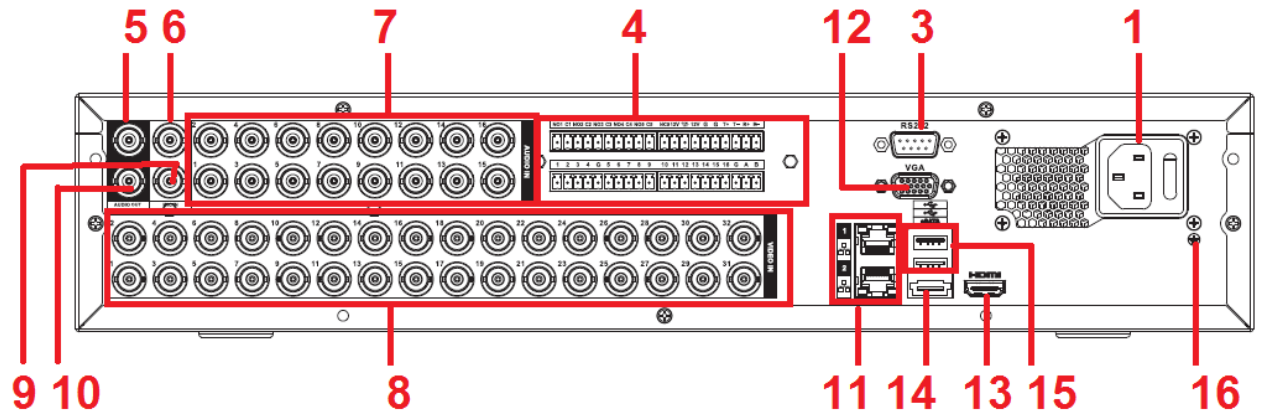







Figure 2-82

Please refer to the following sheet for detailed information.

SN	Icon	Name	Note
1		Power socket	Power socket
2		Power switch	Power on/off button.
3	RS-232	RS-232 debug COM.	It is for general COM debug to configure IP address or transfer transparent COM data.
4	1~16	Alarm input port 1~16	<ul style="list-style-type: none"> There are four groups. The first group is from port 1 to port 4, the second group is from port 5 to port 8, the third group is from 9 to 12, and the fourth group is from 13 to 16. They are to receive the signal from

SN	Icon	Name	Note
			<p>the external alarm source. There are two types; NO (normal open)/NC (normal close).</p> <ul style="list-style-type: none"> ● When your alarm input device is using external power, please make sure the device and the DVR have the same ground.
	NO1~NO5	Alarm output port 1~5	<ul style="list-style-type: none"> ● 5 groups of alarm output ports. (Group 1:port NO1 ~ C1,Group 2:port NO2 ~ C2,Group 3:port NO3~C3, Group 4:port NO4~C4, Group 5: port NO5, C5, NC5).Output alarm signal to the alarm device. Please make sure there is power to the external alarm device. ● NO: Normal open alarm output port. ● C: Alarm output public end. ● NC: Normal close alarm output port.
	C1~C5		
	NC5		
	A	RS-485 communication port	RS485_A port. It is the cable A. You can connect to the control devices such as speed dome PTZ.
	B		RS485_B.It is the cable B. You can connect to the control devices such as speed dome PTZ.
	T+, T-, R+, R-	Four-wire full-duplex 485 port	Four-wire full-duplex 485 port. T+,T- is the output wire. R+,R- is the input wire.
	CTRL 12V	Control power output	Controller 12V power output. It is to control the on-off alarm relay output.
5	AUDIO OUT	Audio output port	Audio output port. It is to output the analog audio signal to the devices such as the sound box.
6	MIC IN	Audio input port	Bidirectional talk input port. It is to receive the analog audio signal output from the devices

SN	Icon	Name	Note
			such as mike phone, pickup.
7	AUDIO IN	Audio input port	It is to receive the analog audio signal output from the devices such as mike phone, pickup.
8	VIDEO IN	Video input port	Connect to analog camera to input video signal.
9	MIC OUT	Audio output port	<p>Audio output port. It is to output the analog audio signal to the devices such as the sound box.</p> <ul style="list-style-type: none"> ● Bidirectional talk output. ● Audio output on 1-window video monitor. ● Audio output on 1-window video playback.
10	VIDEO OUT	Video output port	Connect to video output devices such as TV.
11		Network port	1000M Ethernet port
12	VGA	VGA video output port	VGA video output port. Output analog video signal. It can connect to the monitor to view analog video.
13	HDMI	High Definition Media Interface	High definition audio and video signal output port. It transmits uncompressed high definition video and multiple-channel data to the HDMI port of the display device.
14	eSATA	eSATA port	External SATA port. It can connect to the device of the SATA port. Please jump the HDD when there is peripheral connected HDD.
15		USB2.0 port	USB2.0 port. Connect to mouse, USB storage device, USB burner and etc.

SN	Icon	Name	Note
16		GND	GND

2.2.34 HCVR71XXH-4M Series

The rear panel is shown as in Figure 2-83 .

The following figure is based on the HCVR7116H-4M series product.

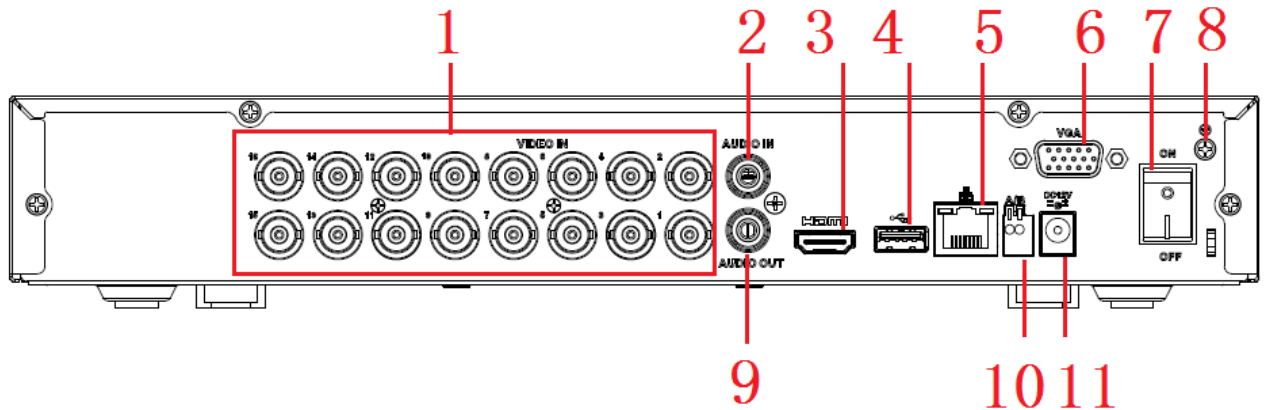

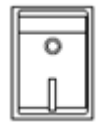



Figure 2-83

Please refer to the following sheet for detailed information.

SN	Icon	Name	Function
1	VIDEO IN	Video input port	Connect to analog camera, video input signal.
2	AUDIO IN	Audio input port	Connect to microphone and etc to input signal.
3	HDMI	High definition media interface	High definition audio and video signal output port. It transmits the same video signal as that of the VGA/TV or different video signal from that of the VG/TV (support customized setup) . Support mouse operation.
4		USB3.0 port	Connect to mouse, USB storage media, USB-burner and etc.
5		Network port	1000M Ethernet port
6	VGA	VGA video output port	VGA video output port. Output analog video signal. It can connect to the monitor to view analog video.
7		Power switch	Power on/off button.

SN	Icon	Name	Function
8		GND	Ground port
9	AUDIO OUT	Audio output port	Connect to sound box and etc to output audio signal.
10	A	RS485 communication port	RS485_A port. It is the cable A. You can connect to the control devices such as speed dome PTZ.
	B		RS485_B. It is the cable B. You can connect to the control devices such as speed dome PTZ.
11		Power socket	Power input port

2.2.35 HCVR72XXAN-4M Series

The rear panel is shown as in Figure 2-84.

The following figure is based on the HCVR7208SAN-4M series product.

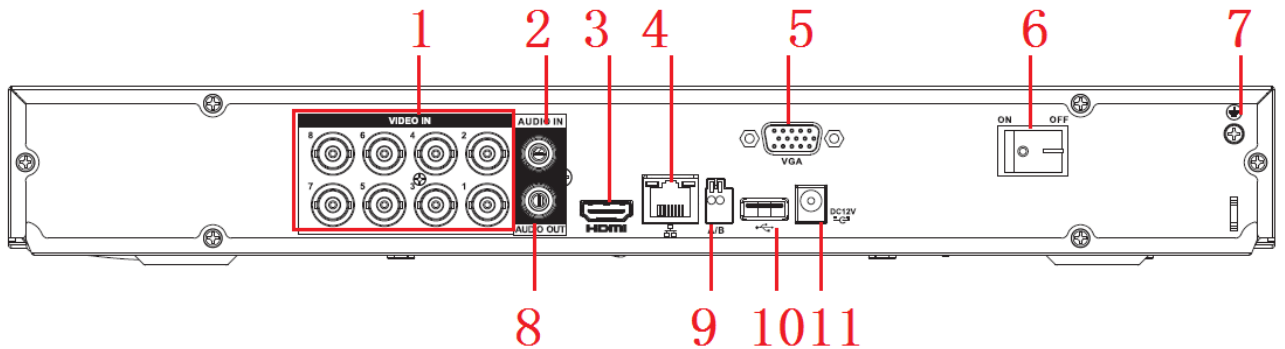

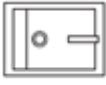



Figure 2-84

Please refer to the following sheet for detailed information.

SN	Icon	Name	Function
1	VIDEO IN	Video input port	Connect to analog camera, video input signal.
2	AUDIO IN	Audio input port	Connect to microphone and etc to input signal.
3	HDMI	High definition media interface	High definition audio and video signal output port. It transmits the same video signal as that of the VGA/TV or different video signal from that of the VGA/TV (support customized setup) . Support mouse operation.
4		Network port	1000M Ethernet port

SN	Icon	Name	Function
5	VGA	VGA	VGA video output port
6		Power switch	Power on/off button.
7	GND	Power switch	Power on/off button.
8	AUDIO OUT	Audio output port	Connect to sound box and etc to output audio signal.
9	A	RS485 communication port	RS485_A port. It is the cable A. You can connect to the control devices such as speed dome PTZ.
	B		RS485_B. It is the cable B. You can connect to the control devices such as speed dome PTZ.
10		USB3.0 port	Connect to mouse, USB storage media, USB-burner and etc.
11		Power socket	Power input port

2.2.36 XVR54XXL/ XVR74XXL Series

The XVR5408L rear panel is shown as below. See Figure 2-85.

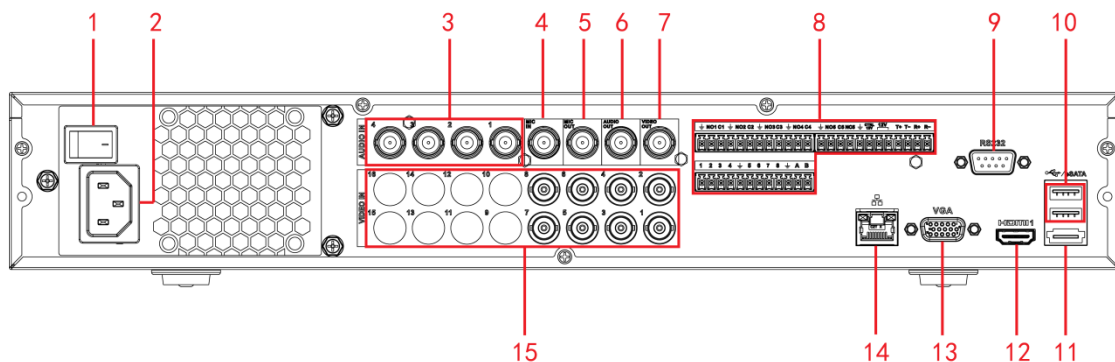





Figure 2-85

Please refer to the following sheet for detailed information.

SN	Icon	Name	Note
1		Power switch	Power on/off button.
2		Power socket	Power socket

SN	Icon	Name	Note
3	AUDIO IN	Audio input port	It is to receive the analog audio signal output from the devices such as microphone.
4	MIC OUT	Audio output port	Audio output port. It is to output the analog audio signal to the devices such as the sound box.
5	MIC IN	Audio input port	Bidirectional talk input port. It is to receive the analog audio signal output from the devices such as microphone, pickup.
6	AUDIO OUT	Audio output port	Audio output port. It is to output the analog audio signal to the devices such as the sound box.
7	VIDEO OUT	Video output port	Connect to video output devices such as TV.
8	1~8	Alarm input port 1~8	<ul style="list-style-type: none"> There are two groups. The first group is from port 1 to port 4; the second group is from port 5 to port 8. They are to receive the signal from the external alarm source. There are two types; NO (normal open)/NC (normal close). When your alarm input device is using external power, please make sure the device and the DVR have the same ground.
	NO1~NO5	Alarm output port 1~5	<ul style="list-style-type: none"> 5 groups of alarm output ports. (Group 1:port NO1~C1,Group 2:port NO2~C2,Group 3:port NO3~C3, Group 4:port NO4~C4, Group 5: port NO5, C5, NC5).Output alarm signal to the alarm device. Please make sure there is power to the external alarm device. NO: Normal open alarm output port. C: Alarm output public end. NC: Normal close alarm output port.
	C1~C5		
	NC5		
A	RS-485 communication port	RS485_A port. It is the cable A. You can connect to the control devices such as speed dome PTZ.	

SN	Icon	Name	Note
	B		RS485_B.It is the cable B. You can connect to the control devices such as speed dome PTZ.
	T+, T-, R+, R-	Four-wire full-duplex 485 port	Four-wire full-duplex 485 port. T+,T- is the output wire. R+,R- is the input wire.
	CTRL 12V	Control power output	Controller 12V power output. It is to control the on-off alarm relay output.
	12V	+12V power output port	+12V power output port. It can provide the power to some peripheral devices such as the camera or the alarm device. Please note the supplying power shall be below 1A.
	G	Ground	Ground
9	RS-232	RS232 debug COM.	It is for general COM debug to configure IP address or transfer transparent COM data.
10		USB port	Connect to USB storage device, mouse, burning DVD-ROM and etc.
11	eSATA	eSATA port	External SATA port. It can connect to the device of the SATA port. Please make sure there is power supplying when there is peripheral connected HDD.
12	HDMI 1	High Definition Media Interface	High definition audio and video signal output port. It transmits uncompressed high definition video and multiple-channel data to the HDMI port of the display device.
13	VGA	VGA video output port	VGA video output port. Output analog video signal. Can connect to the monitor to view analog video output.
14		Network port	1000Mbps Ethernet port
15	VIDEO IN	Video input port	Connect to analog camera, video input signal.

The XVR5416L/XVR7408L/XVR7416L rear panel is shown as below. See Figure 2-86.

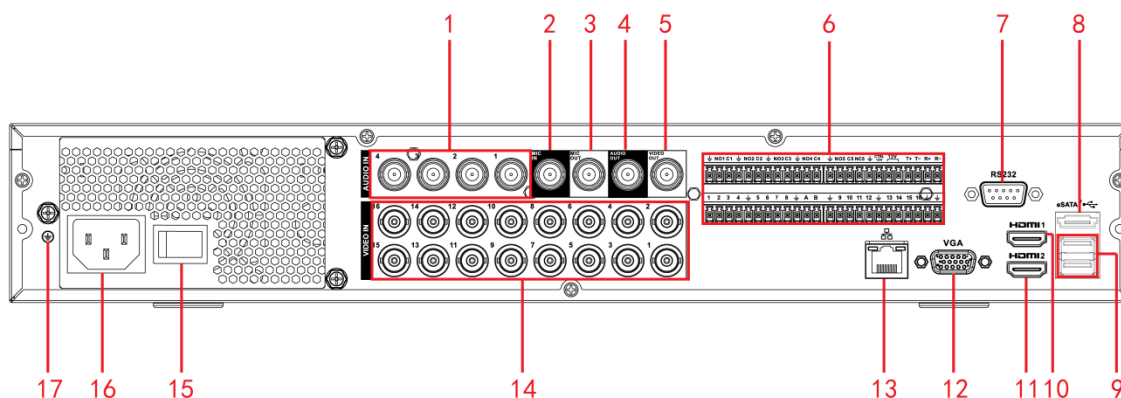



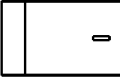



Figure 2-86

Please refer to the following sheet for detailed information.

SN	Icon	Name	Note
1	AUDIO IN	Audio input port	It is to receive the analog audio signal output from the devices such as microphone.
2	MIC OUT	Audio output port	Audio output port. It is to output the analog audio signal to the devices such as the sound box.
3	MIC IN	Audio input port	It is to receive the analog audio signal output from the devices such as microphone.
4	AUDIO OUT	Audio output port	Audio output port. It is to output the analog audio signal to the devices such as the sound box.
5	VIDEO OUT	Video output port	Connect to video output devices such as TV.
6	1~16	Alarm input port 1~16	<ul style="list-style-type: none"> There are four groups. The first group is from port 1 to port 4, the second group is from port 5 to port 8, the third group is from 9 to 12, and the fourth group is from 13 to 16. They are to receive the signal from the external alarm source. There are two types; NO (normal open)/NC (normal close). When your alarm input device is using external power, please make sure the device and the DVR have the same ground.
	NO1~NO5	Alarm output port 1~5	<ul style="list-style-type: none"> 5 groups of alarm output ports. (Group 1:port NO1~C1,Group 2:port NO2~C2,Group 3:port
	C1~C5		

SN	Icon	Name	Note
	NC5		<p>NO3~C3, Group 4:port NO4~C4, Group 5: port NO5, C5, NC5).Output alarm signal to the alarm device. Please make sure there is power to the external alarm device.</p> <ul style="list-style-type: none"> ● NO: Normal open alarm output port. ● C: Alarm output public end. ● NC: Normal close alarm output port.
	A	RS-485 communication port	RS485_A port. It is the cable A. You can connect to the control devices such as speed dome PTZ.
	B		RS485_B.It is the cable B. You can connect to the control devices such as speed dome PTZ.
	T+, T-, R+, R-	Four-wire full-duplex 485 port	Four-wire full-duplex 485 port. T+,T- is the output wire. R+,R- is the input wire.
	CTRL 12V	Control power output	Controller 12V power output. It is to control the on-off alarm relay output.
	12V	+12V power output port	+12V power output port. It can provide the power to some peripheral devices such as the camera or the alarm device. Please note the supplying power shall be below 1A.
		Ground	Ground
7	RS-232	RS232 debug COM.	It is for general COM debug to configure IP address or transfer transparent COM data.
8	eSATA	eSATA port	External SATA port. It can connect to the device of the SATA port. Please make sure there is power supplying when there is peripheral connected HDD.
9		USB port	Connect to USB storage device, mouse, burning DVD-ROM and etc.

SN	Icon	Name	Note
10	HDMI1	High Definition Media Interface 1	High definition audio and video signal output port. It outputs the same video source as VGA/TV. Support mouse operation and control.
11	HDMI2	High Definition Media Interface 2	High definition audio and video signal output port. Support multiple-window video matrix output. Support four function.
12	VGA	VGA video output port	VGA video output port. Output analog video signal. Can connect to the monitor to view analog video output.
13		Network port	1000Mbps Ethernet port
14	VIDEO IN	Video input port	Connect to analog camera, video input signal.
15		Power switch	Power on/off button.
16		Power socket	Power socket
17		Ground terminal	Ground

The XVR5432L rear panel is shown as below. See Figure 2-87.

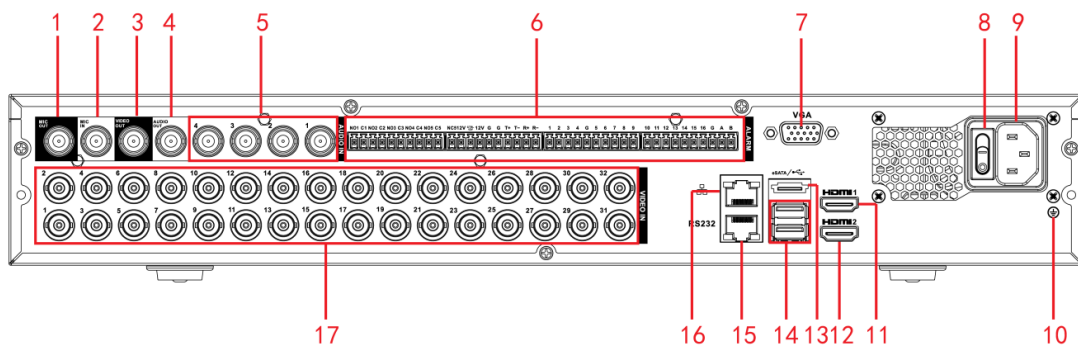







Figure 2-87

Please refer to the following sheet for detailed information.

SN	Icon	Name	Note
1	MIC OUT	Audio output port	Audio output port. It is to output the analog audio signal to the devices such as the sound box.

SN	Icon	Name	Note
2	MIC IN	Audio input port	Bidirectional talk input port. It is to receive the analog audio signal output from the devices such as microphone, pickup.
3	VIDEO OUT	Video output port	Connect to video output devices such as TV.
4	AUDIO OUT	Audio output port	Audio output port. It is to output the analog audio signal to the devices such as the sound box.
5	AUDIO IN	Audio input port	It is to receive the analog audio signal output from the devices such as microphone.
6	1~16	Alarm input port 1~16	<ul style="list-style-type: none"> There are four groups. The first group is from port 1 to port 4, the second group is from port 5 to port 8, the third group is from 9 to 12, and the fourth group is from 13 to 16. They are to receive the signal from the external alarm source. There are two types; NO (normal open)/NC (normal close). When your alarm input device is using external power, please make sure the device and the DVR have the same ground.
	NO1~NO5	Alarm output port 1~5	<ul style="list-style-type: none"> 5 groups of alarm output ports. (Group 1:port NO1~C1,Group 2:port NO2~C2,Group 3:port NO3~C3, Group 4:port NO4~C4, Group 5: port NO5, C5, NC5).Output alarm signal to the alarm device. Please make sure there is power to the external alarm device. NO: Normal open alarm output port. C: Alarm output public end. NC: Normal close alarm output port.
	C1~C5		
	NC5		
	A	RS-485 communication port	RS485_A port. It is the cable A. You can connect to the control devices such as speed dome PTZ.
B	RS485_B.It is the cable B. You can connect to the control devices such as speed dome PTZ.		

SN	Icon	Name	Note
	T+, T-, R+, R-	Four-wire full-duplex 485 port	Four-wire full-duplex 485 port. T+,T- is the output wire. R+,R- is the input wire.
	CTRL 12V	Control power output	Controller 12V power output. It is to control the on-off alarm relay output.
	12V	+12V power output port	+12V power output port. It can provide the power to some peripheral devices such as the camera or the alarm device. Please note the supplying power shall be below 1A.
		Ground	Ground
7	VGA	VGA video output port	VGA video output port. Output analog video signal. Can connect to the monitor to view analog video output.
8		Power switch	Power on/off button.
9		Power socket	Power socket
10		Ground terminal	Ground
11	HDMI1	High Definition Media Interface 1	High definition audio and video signal output port. It outputs the same video source as VGA/TV. Support mouse operation and control.
12	HDMI2	High Definition Media Interface 2	High definition audio and video signal output port. Support multiple-window video matrix output. Support four function.
13	eSATA	eSATA port	External SATA port. It can connect to the device of the SATA port. Please make sure there is power supplying when there is peripheral connected HDD.
14		USB port	Connect to USB storage device, mouse, burning DVD-ROM and etc.

SN	Icon	Name	Note
15	RS-232	RS232 debug COM.	It is for general COM debug to configure IP address or transfer transparent COM data.
16		Network port	1000Mbps Ethernet port
17	VIDEO IN	Video input port	Connect to analog camera, video input signal.

2.2.37 XVR58XXS/ XVR78XXS Series

The XVR5808S rear panel is shown as below. See Figure 2-88.

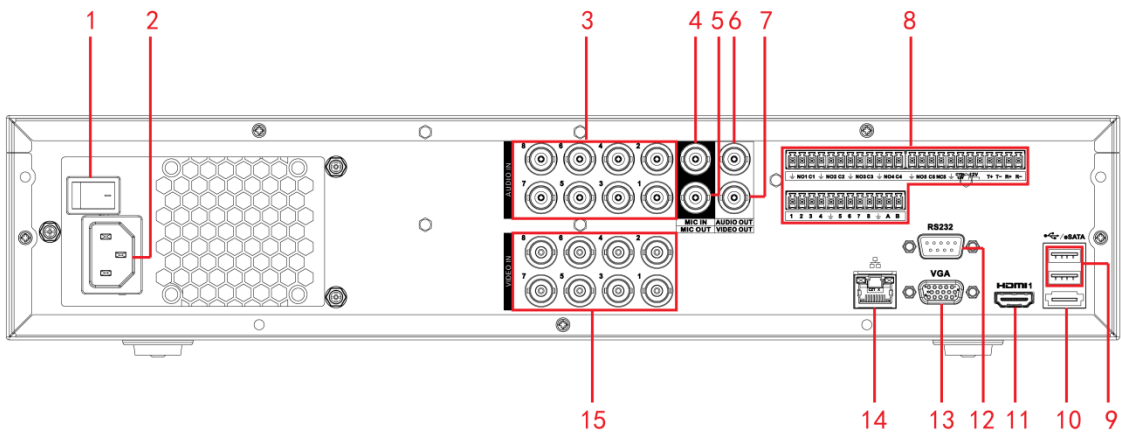

Figure 2-88

The XVR7808S/XVR7816S rear panel is shown as below. See Figure 2-89.

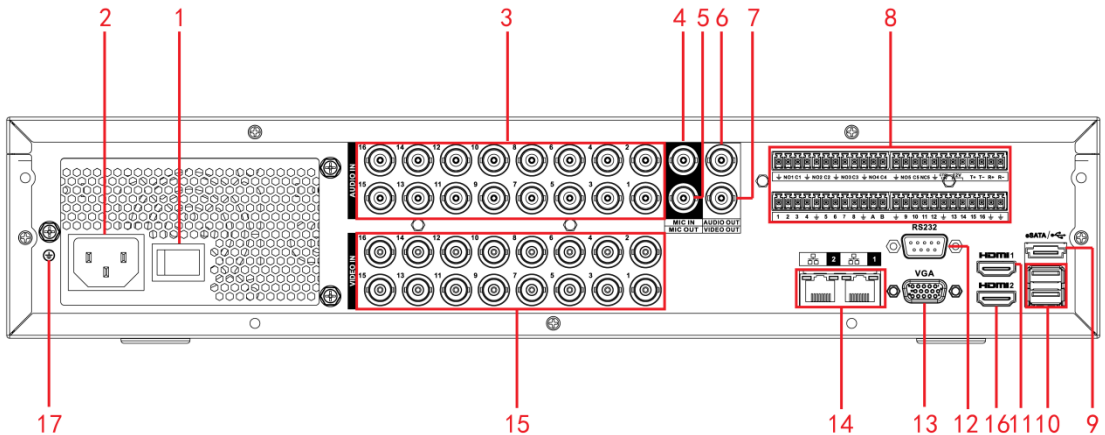







Figure 2-89

Please refer to the following sheet for detailed information.

SN	Icon	Name	Note
----	------	------	------

SN	Icon	Name	Note
1		Power switch	Power on/off button.
2		Power socket	Power socket
3	AUDIO IN	Audio input port	It is to receive the analog audio signal output from the devices such as microphone.
4	MIC IN	Audio input port	Bidirectional talk input port. It is to receive the analog audio signal output from the devices such as microphone, pickup.
5	MIC OUT	Audio output port	Audio output port. It is to output the analog audio signal to the devices such as the sound box.
6	AUDIO OUT	Audio output port	Audio output port. It is to output the analog audio signal to the devices such as the sound box.
7	VIDEO OUT	Video output port	Connect to video output devices such as TV.
8	1~8	Alarm input port 1~8	<ul style="list-style-type: none"> There are two groups. The first group is from port 1 to port 4; the second group is from port 5 to port 8. They are to receive the signal from the external alarm source. There are two types; NO (normal open)/NC (normal close). When your alarm input device is using external power, please make sure the device and the DVR have the same ground.
	NO1~NO5	Alarm output port 1~5	<ul style="list-style-type: none"> 5 groups of alarm output ports. (Group 1:port NO1~C1,Group 2:port NO2~C2,Group 3:port NO3~C3, Group 4:port NO4~C4, Group 5: port NO5, C5,
	C1~C5		

SN	Icon	Name	Note
	NC5		<p>NC5).Output alarm signal to the alarm device. Please make sure there is power to the external alarm device.</p> <ul style="list-style-type: none"> ● NO: Normal open alarm output port. ● C: Alarm output public end. ● NC: Normal close alarm output port.
	A	RS-485 communication port	RS485_A port. It is the cable A. You can connect to the control devices such as speed dome PTZ.
	B		RS485_B.It is the cable B. You can connect to the control devices such as speed dome PTZ.
	T+, T-, R+, R-	Four-wire full-duplex 485 port	Four-wire full-duplex 485 port. T+,T- is the output wire. R+,R- is the input wire.
	CTRL 12V	Control power output	Controller 12V power output. It is to control the on-off alarm relay output.
	12V	+12V power output port	+12V power output port. It can provide the power to some peripheral devices such as the camera or the alarm device. Please note the supplying power shall be below 1A.
	G	Ground terminal	Ground
9		USB port	Connect to USB storage device, mouse, burning DVD-ROM and etc.
10	eSATA	eSATA port	External SATA port. It can connect to the device of the SATA port. Please make sure there is power supplying when there is peripheral connected HDD.
11	HDMI 1	High Definition Media Interface 1	High definition audio and video signal output port. It outputs the same video source as VGA/TV. Support mouse operation and control.
12	RS-232	RS232 debug COM.	It is for general COM debug to configure IP address or transfer transparent COM data.

SN	Icon	Name	Note
13	VGA	VGA video output port	VGA video output port. Output analog video signal. Can connect to the monitor to view analog video output.
14		Network port	1000Mbps Ethernet port
15	VIDEO IN	Video input port	Connect to analog camera, video input signal.
16	HDMI2	High Definition Media Interface 2	High definition audio and video signal output port. Support multiple-window video matrix output. Support four function.
17		Ground terminal	Ground

The XVR5832S rear panel is shown as below. See Figure 2-90.

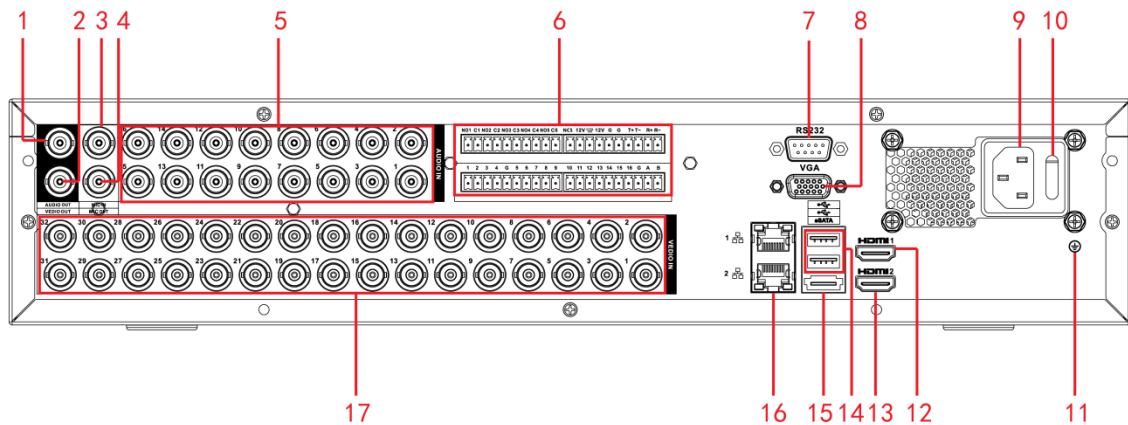







Figure 2-90

Please refer to the following sheet for detailed information.

SN	Icon	Name	Note
1	AUDIO OUT	Audio output port	Audio output port. It is to output the analog audio signal to the devices such as the sound box.
2	VIDEO OUT	Video output port	Connect to video output devices such as TV.
3	MIC IN	Audio input port	Bidirectional talk input port. It is to receive the analog audio signal output from the devices such as microphone, pickup.

SN	Icon	Name	Note
4	MIC OUT	Audio output port	Audio output port. It is to output the analog audio signal to the devices such as the sound box.
5	AUDIO IN	Audio input port	It is to receive the analog audio signal output from the devices such as microphone.
6	1~16	Alarm input port 1~16	<ul style="list-style-type: none"> There are four groups. The first group is from port 1 to port 4, the second group is from port 5 to port 8, the third group is from 9 to 12, and the fourth group is from 13 to 16. They are to receive the signal from the external alarm source. There are two types; NO (normal open)/NC (normal close). When your alarm input device is using external power, please make sure the device and the DVR have the same ground.
	NO1~NO5	Alarm output port 1~5	<ul style="list-style-type: none"> 5 groups of alarm output ports. (Group 1:port NO1~C1,Group 2:port NO2~C2,Group 3:port NO3~C3, Group 4:port NO4~C4, Group 5: port NO5, C5, NC5).Output alarm signal to the alarm device. Please make sure there is power to the external alarm device. NO: Normal open alarm output port. C: Alarm output public end. NC: Normal close alarm output port.
	C1~C5		
	NC5		
	A	RS-485 communication port	RS485_A port. It is the cable A. You can connect to the control devices such as speed dome PTZ.
	B		RS485_B.It is the cable B. You can connect to the control devices such as speed dome PTZ.
	T+, T-, R+, R-	Four-wire full-duplex 485 port	Four-wire full-duplex 485 port. T+,T- is the output wire. R+,R- is the input wire.
	CTRL 12V	Control power output	Controller 12V power output. It is to control the on-off alarm relay output.
12V	+12V power output	+12V power output port. It can	

SN	Icon	Name	Note
		port	provide the power to some peripheral devices such as the camera or the alarm device. Please note the supplying power shall be below 1A.
	G	Ground	Ground
7	RS-232	RS232 debug COM.	It is for general COM debug to configure IP address or transfer transparent COM data.
8	VGA	VGA video output port	VGA video output port. Output analog video signal. Can connect to the monitor to view analog video output.
9		Power socket	Power socket
10		Power switch	Power on/off button.
11		Ground terminal	Ground
12	HDMI 1	High Definition Media Interface 1	High definition audio and video signal output port. It outputs the same video source as VGA/TV. Support mouse operation and control.
13	HDMI2	High Definition Media Interface 2	High definition audio and video signal output port. Support multiple-window video matrix output. Support tour function.
14		USB port	Connect to USB storage device, mouse, burning DVD-ROM and etc.
15	eSATA	eSATA port	External SATA port. It can connect to the device of the SATA port. Please make sure there is power supplying when there is peripheral connected HDD.
16		Network port	1000Mbps Ethernet port
17	VIDEO IN	Video input port	Connect to analog camera, video input signal.

2.2.38 HCR710XH-4K Series

This series product rear panel is shown as in Figure 2-91.
Here we use HCVR7108H-4K for an example.

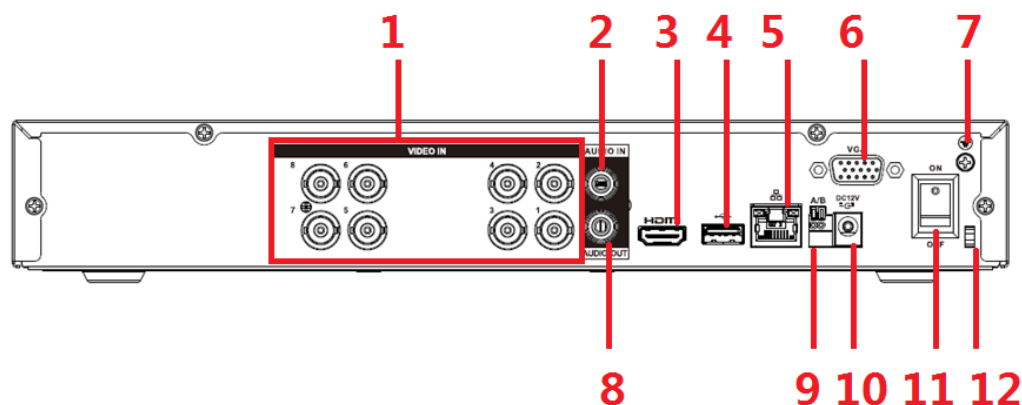







Figure 2-91

Please refer to the following sheet for detailed information.

SN	Icon	Name	Note
1	VIDEO IN	Video input port	Connect to analog camera, video input signal.
2	AUDIO IN	Audio input port	Connect to audio input device such as speaker.
3	HDMI	High Definition Media Interface	High definition audio and video signal output port. It transmits uncompressed high definition video and multiple-channel data to the HDMI port of the display device.
4		USB port	Connect to USB storage device, mouse, burning DVD-ROM and etc.
5		Network port	1000M Ethernet port
6	VGA	VGA video output port	VGA video output port. Output analog video signal. Can connect to the monitor to view analog video output.
7		GND	Ground end
8	AUDIO OUT	Audio output port	Connect to video output device such as sound box.
9	A	RS485 (RS-485) communication port	RS485_A port. It is the cable A. You can connect to the control devices such as speed dome PTZ.
	B		RS485_B. It is the cable B. You can connect to the control devices such as speed dome PTZ.
10		Power input port	Input 12V DC.
11		Power switch	Power on/off button.

SN	Icon	Name	Note
12		Power cable fastener	Use clamp to secure the power cable on the device in case there is any loss.

2.2.39 HCVR720XAN-4K Series

This series product rear panel is shown as in Figure 2-92.

Here we use HCVR7108AN-4K for an example.

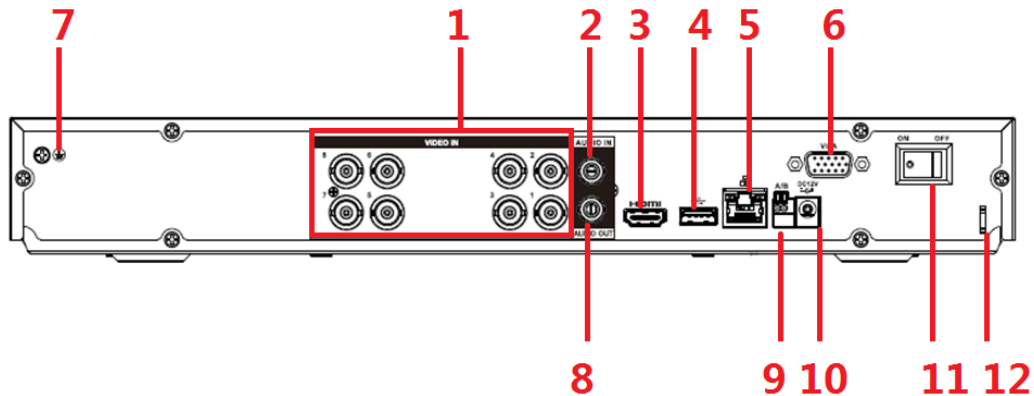







Figure 2-92

Please refer to the following sheet for detailed information.

SN	Icon	Name	Note
1	VIDEO IN	Video input port	Connect to analog camera, video input signal.
2	AUDIO IN	Audio input port	Connect to audio input device such as speaker.
3	HDMI	High Definition Media Interface	High definition audio and video signal output port. It transmits uncompressed high definition video and multiple-channel data to the HDMI port of the display device.
4		USB port	Connect to USB storage device, mouse, burning DVD-ROM and etc.
5		Network port	1000M Ethernet port
6	VGA	VGA video output port	VGA video output port. Output analog video signal. Can connect to the monitor to view analog video output.
7		GND	Ground end
8	AUDIO OUT	Audio output port	Connect to video output device such as sound box.
9	A	RS485 (RS-485)	RS485_A port. It is the cable A. You can connect to the control devices such as speed dome PTZ.

SN	Icon	Name	Note
	B	communication port	RS485_B.It is the cable B. You can connect to the control devices such as speed dome PTZ.
10		Power input port	Input 12V DC.
11		Power switch	Power on/off button.
12		Power cable fastener	Use clamp to secure the power cable on the device in case there is any loss.

2.2.40 XVR5108H-4KL-8P Series



CAUTION

Before using the PoC function, please read the following notices carefully.

- When you are using PoC function, make sure the connected coaxial cable appearance is OK. The bare copper core may result in electric shock!
- This series product supports 6W camera and 12W camera. 12V/0.5A PoC camera belongs to the 6W camera category and 12V/1A camera belongs to the 12W camera category. PD module belongs to 12W camera category. If the channel prompts "Power overloading", that is to say each 4 channels' (1-4, 5-8 and so on.) total power consumption has exceeded 24W. Device automatically stops providing power to the camera. Please connect current camera to another 4 channels group.
- Refer to the following sheet for detailed information.

PoC power supplying category	Note	Samples
6W camera category	Working power 12V Current \leq 0.5A	HDW1400EMP-PoC series HDW1200EMP-PoC series HFW1200SN-PoC series
12W camera category	After the DVR connected to the PD module, the connected non-PoC camera can use PoC function. Right now device maximally supports the 12W camera.	PFM811-C series
	Working power 12V Current \leq 1A	HFW2231RP-Z-IRE6-PoC series HDBW2231RP-Z-PoC series

This series product rear panel is shown as in Figure 2-93.

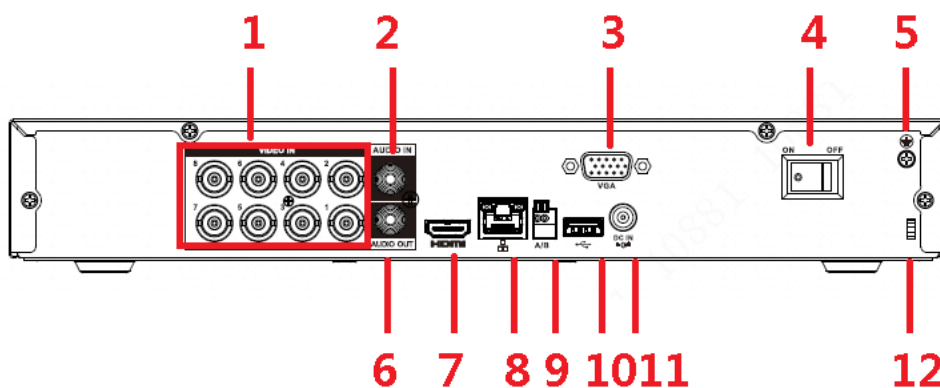
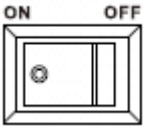







Figure 2-93

Please refer to the following sheet for detailed information.

SN	Icon	Name	Note
1	VIDEO IN	Video input port	Connect to analog camera, video input signal.
		PoC port	8-channel. Each channel max supports 12W. Support power over coax (PoC) function. It can provide power to the connected camera.
2	AUDIO IN	Audio input port	Connect to audio input device such as speaker.
3	VGA	VGA video output port	VGA video output port. Output analog video signal. Can connect to the monitor to view analog video output.
4		Power on-off button	Power on/off button.
5		GND	Ground end
6	AUDIO OUT	Audio output port	Connect to video output device such as sound box.
7	HDMI	High definition media interface	High definition audio and video signal output port. It transmits uncompressed high definition video and multiple-channel data to the HDMI port of the display

			device.
8		Network port	100M Ethernet port
9	A	RS485 (RS-485) communication port	RS485_A port. It is the cable A. You can connect to the control devices such as speed dome PTZ.
	B		RS485_B. It is the cable B. You can connect to the control devices such as speed dome PTZ.
10		USB2.0 port	Connect to USB storage device, mouse, burning DVD-ROM and etc.
11		Power input port	Input DC 48V1.5A.
12		Power cable fastener	Use clamp to secure the power cable on the device in case there is any loss.

2.2.41 XVR5208AN-4KL-8P/XVR5216AN-4KL-16P Series



CAUTION

Before using the PoC function, please read the following notices carefully.

- When you are using PoC function, make sure the connected coaxial cable appearance is OK. The bare copper core may result in electric shock!
- This series product supports 6W camera and 12W camera. 12V/0.5A PoC camera belongs to the 6W camera category and 12V/1A camera belongs to the 12W camera category. PD module belongs to 12W camera category. If the channel prompts "Power overloading", that is to say each 4 channels' (1-4, 5-8 and so on.) total power consumption has exceeded 24W. Device automatically stops providing power to the camera. Please connect current camera to another 4 channels group.
- Refer to the following sheet for detailed information.

PoC power supplying category	Note	Samples
6W camera category	Working power 12V Current≤0.5A	HDW1400EMP-PoC series HDW1200EMP-PoC series HFW1200SN-PoC series

12W camera category	After the DVR connected to the PD module, the connected non-PoC camera can use PoC function. Right now device maximally supports the 12W camera.	PFM811-C series
	Working power 12V Current≤1A	HFW2231RP-Z-IRE6-PoC series HDBW2231RP-Z-PoC series

The XVR5208AN-4KL-8P series product rear panel is shown as in Figure 2-94.

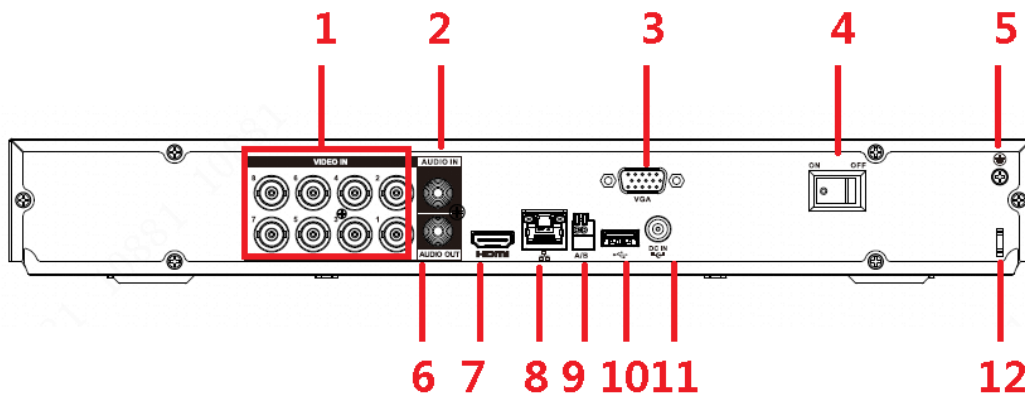

Figure 2-94

The XVR5216AN-4KL-16P series product rear panel is shown as in Figure 2-95.

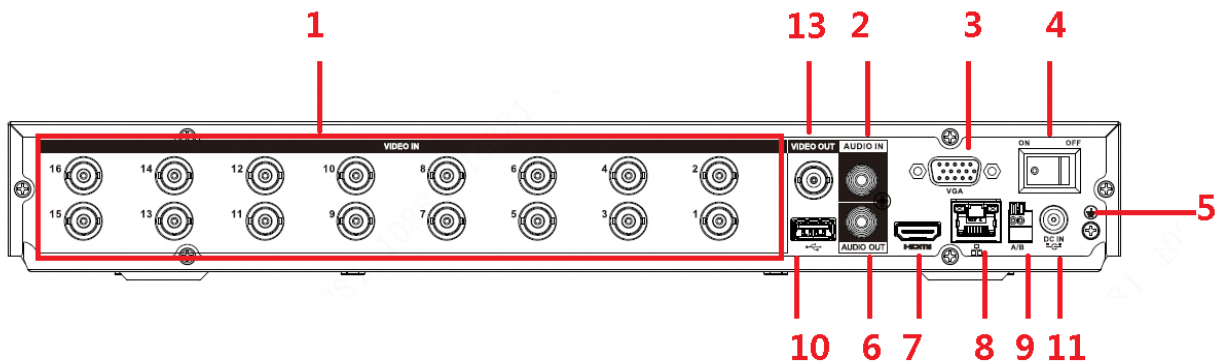
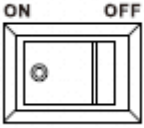







Figure 2-95

Please refer to the following sheet for detailed information.

SN	Icon	Name	Note
1	VIDEO IN	Video input port	Connect to analog camera, video input signal.
		PoC port	Support power over coax (PoC) function. It can provide power to the connected camera.

			<ul style="list-style-type: none"> ● The XVR5208AN-4KL-8P I series product supports 8-channel PoC port. ● The XVR5216AN-4KL-16P series product supports 16-channel PoC port.
2	AUDIO IN	Audio input port	Connect to audio input device such as speaker.
3	VGA	VGA video output port	VGA video output port. Output analog video signal. Can connect to the monitor to view analog video output.
4		Power on-off button	Power on/off button.
5		GND	Ground end
6	AUDIO OUT	Audio output port	Connect to video output device such as sound box.
7	HDMI	High definition media interface	High definition audio and video signal output port. It transmits uncompressed high definition video and multiple-channel data to the HDMI port of the display device.
8		Network port	100M Ethernet port
9	A	RS485 (RS-485) communication port	RS485_A port. It is the cable A. You can connect to the control devices such as speed dome PTZ.
	B		RS485_B.It is the cable B. You can connect to the control devices such as speed dome PTZ.
10		USB2.0 port	Connect to USB storage device, mouse, burning DVD-ROM and etc.

11		Power input port	<ul style="list-style-type: none"> ● 8-channel: Input DC 48V 2A. ● 16-channel: Input DC 48V 2.5A.
12		Power cable fastener	Use clamp to secure the power cable on the device in case there is any loss.
13	VIDEO OUT	Video output port	Connect to video output devices such as TV.

2.2.42 XVR1A04/XVR1A08 Series

The following figure is based on the XVR1A08 series product. See Figure 2-96.

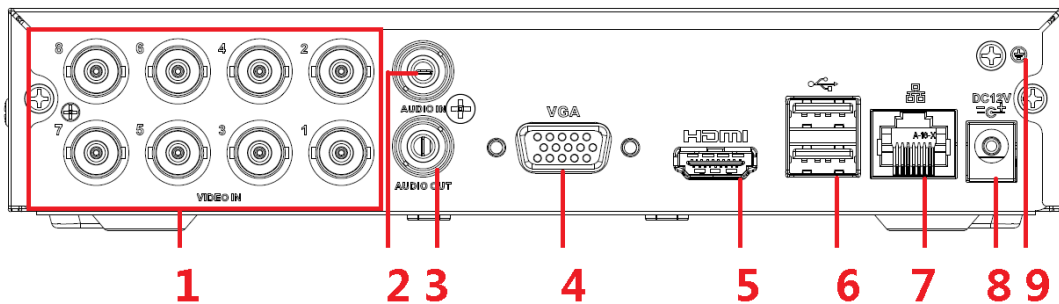



Figure 2-96

SN	Icon	Name	Note
1	VIDEO IN	Video input port	Connect to analog camera, video input signal.
2	AUDIO IN	Audio input port	Connect to audio input device such as speaker.
3	AUDIO OUT	Audio output port	Connect to video output device such as sound box.
4	VGA	VGA	VGA video output port
5	HDMI	High definition media interface	High definition audio and video signal output port. It transmits uncompressed high definition video and multiple-channel data to the HDMI port of the display device.
6		USB port	Connect to USB storage device, mouse, burning DVD-ROM and etc.
7		Network port	100M Ethernet port

8	DC 12V -G	Power input port	Input 12V DC.
9	⊕	Ground terminal	Ground

When connect the Ethernet port, please use crossover cable to connect the PC and use the straight cable to connect to the switch or router.

2.3 Connection Sample

2.3.1 Smart Box Series

Please refer to Figure 2-97 for connection sample.

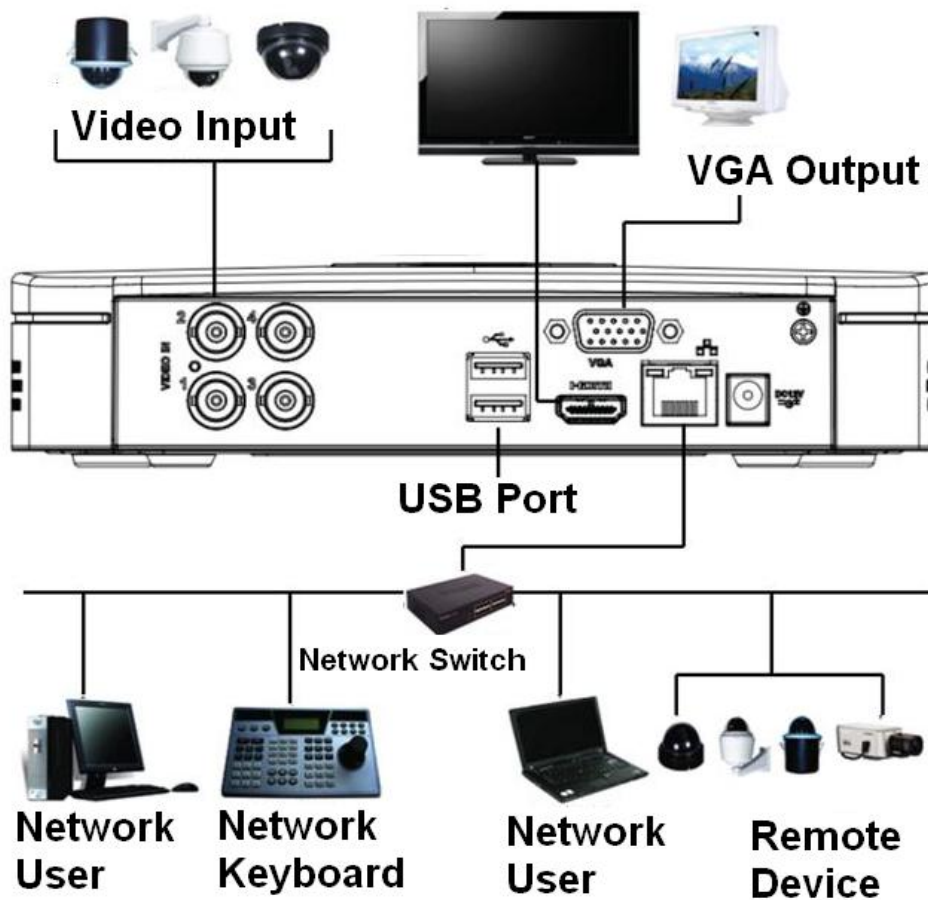

Figure 2-97

2.3.2 Smart 1U Series

Please refer to Figure 2-98 for connection sample.

The following figure is based on the HCVR4108C-S3/5108C-S3/XVR4108C/5108C series.

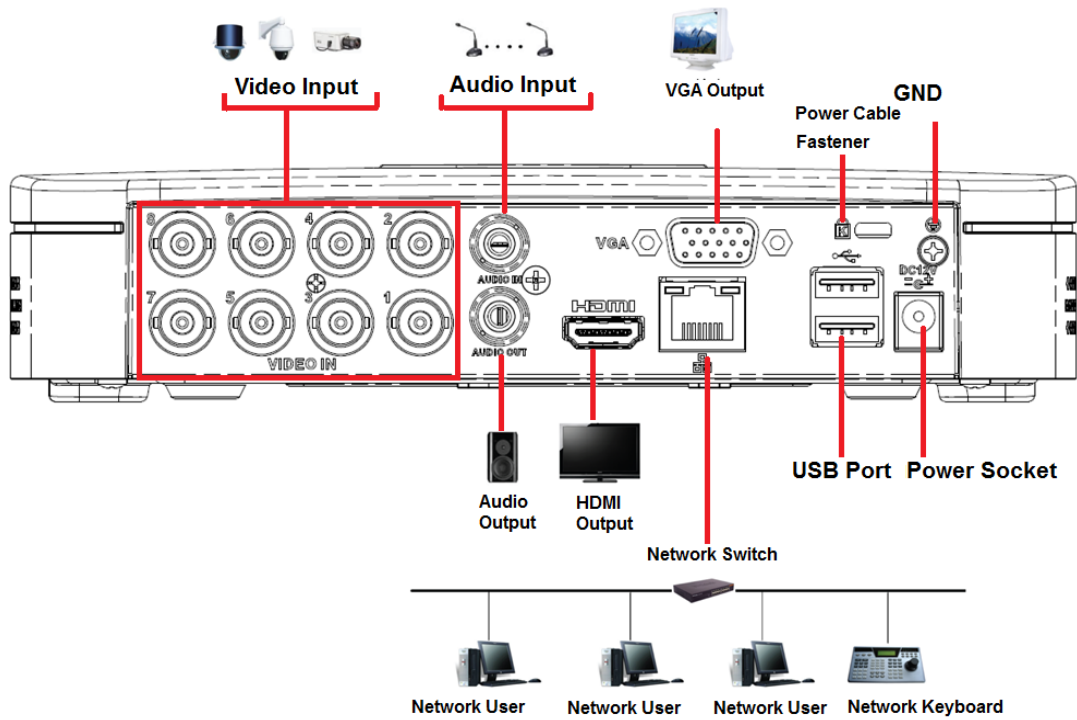

Figure 2-98

2.3.3 Compact 1U/Cooper 1U Series

Please refer to Figure 2-99 for connection sample.

The following figure is based on the HCVR2116HS-S3/HCVR4116HS-S3/5116HS-S3 /XVR2116HS/XVR4116HS/5116HS/XVR1A04/XVR1A08 series product.

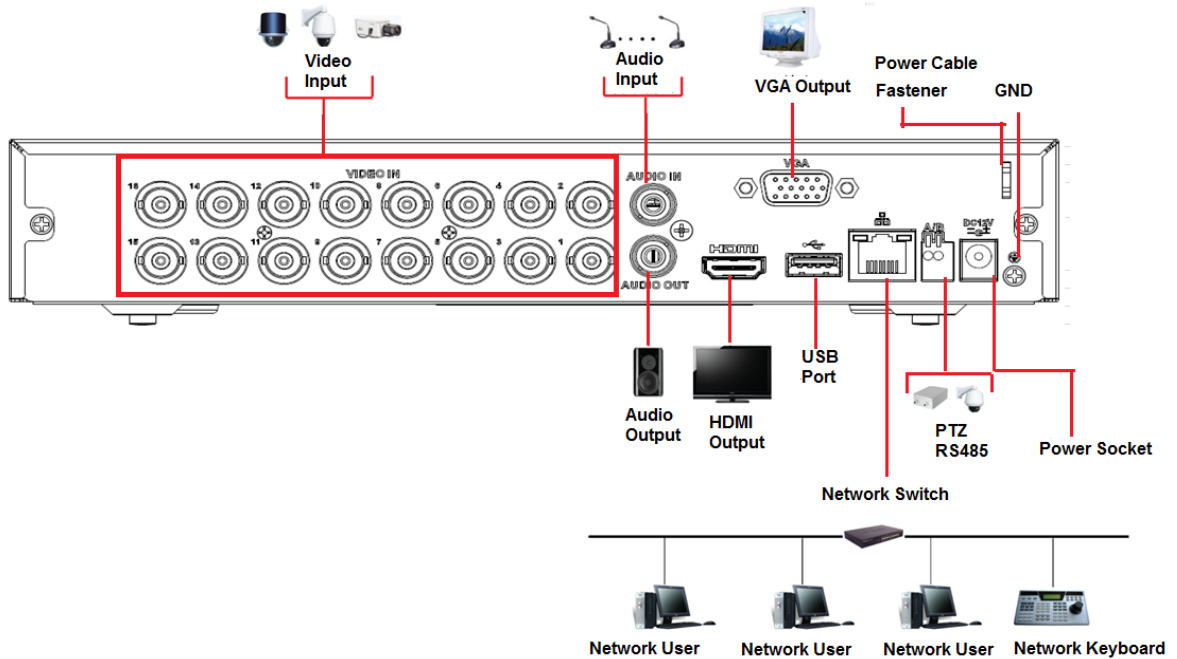

Figure 2-99

2.3.4 Mini 1U Series

Please refer to Figure 2-100 for connection sample.

The following figure is based on HCVR4116HE-S3/HCVR5116HE-S3/HCVR7116HE-S3 /XVR4116HE/XVR5116HE/XVR7116HE series.

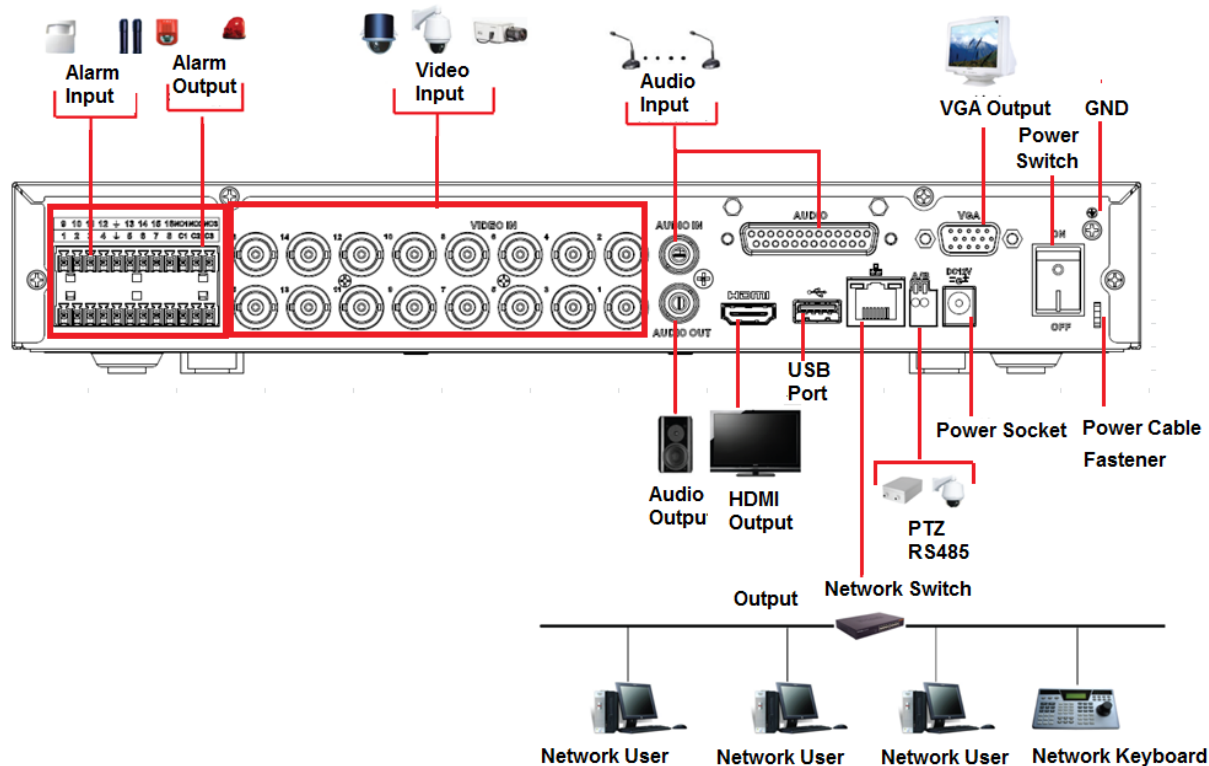

Figure 2-100

2.3.5 1U Series

Please refer to the following figure for detailed information. See Figure 2-101.

The following interface is based on the HCVR4216A-S3/HCVR5216A-S3/ HCVR7216A-S3/XVR4216A/XVR5216A/XVR7216A series product.

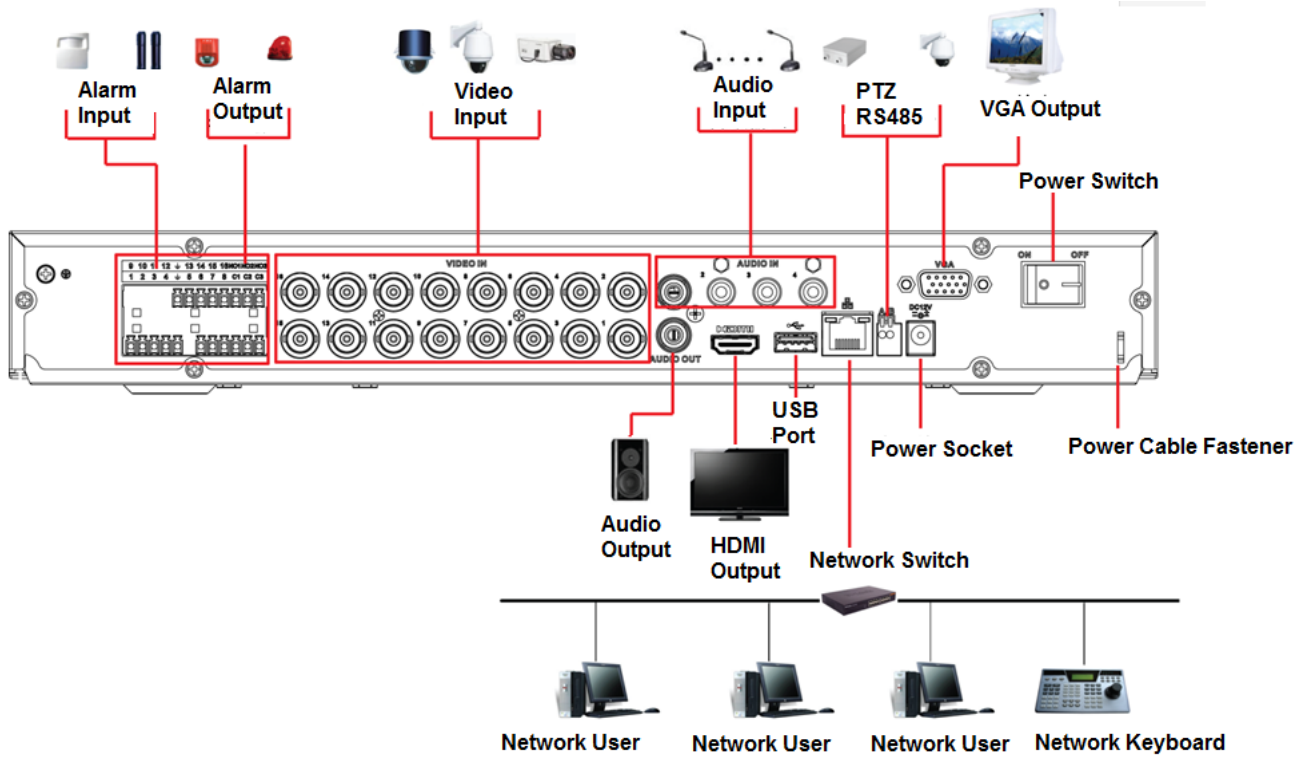

Figure 2-101

2.3.6 1.5U Series

The connection sample is shown as below. See Figure 2-102.

The following interface is based on the HCVR4232L-S2 series product.

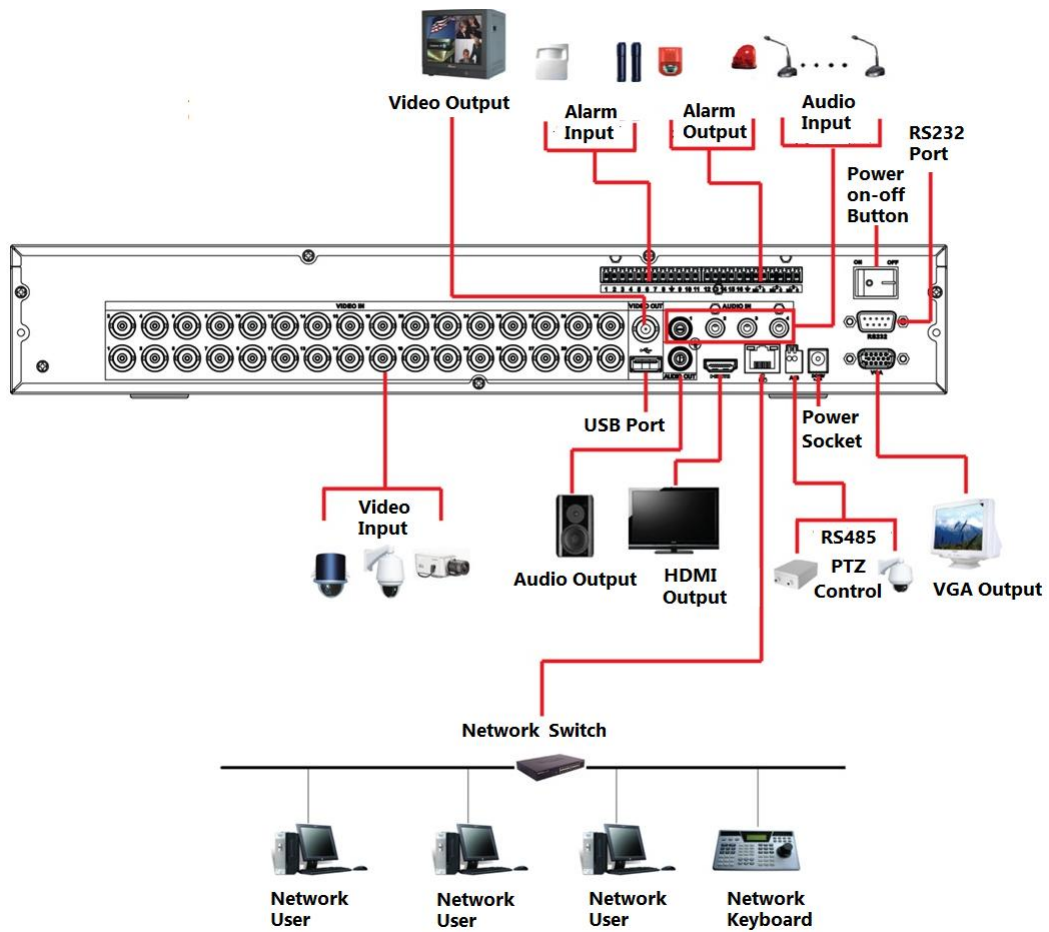

Figure 2-102

2.3.7 2U Series

Please refer to the following figure for detailed information. See Figure 2-103. The following interface is based on the HCVR5816S-V2 series product.

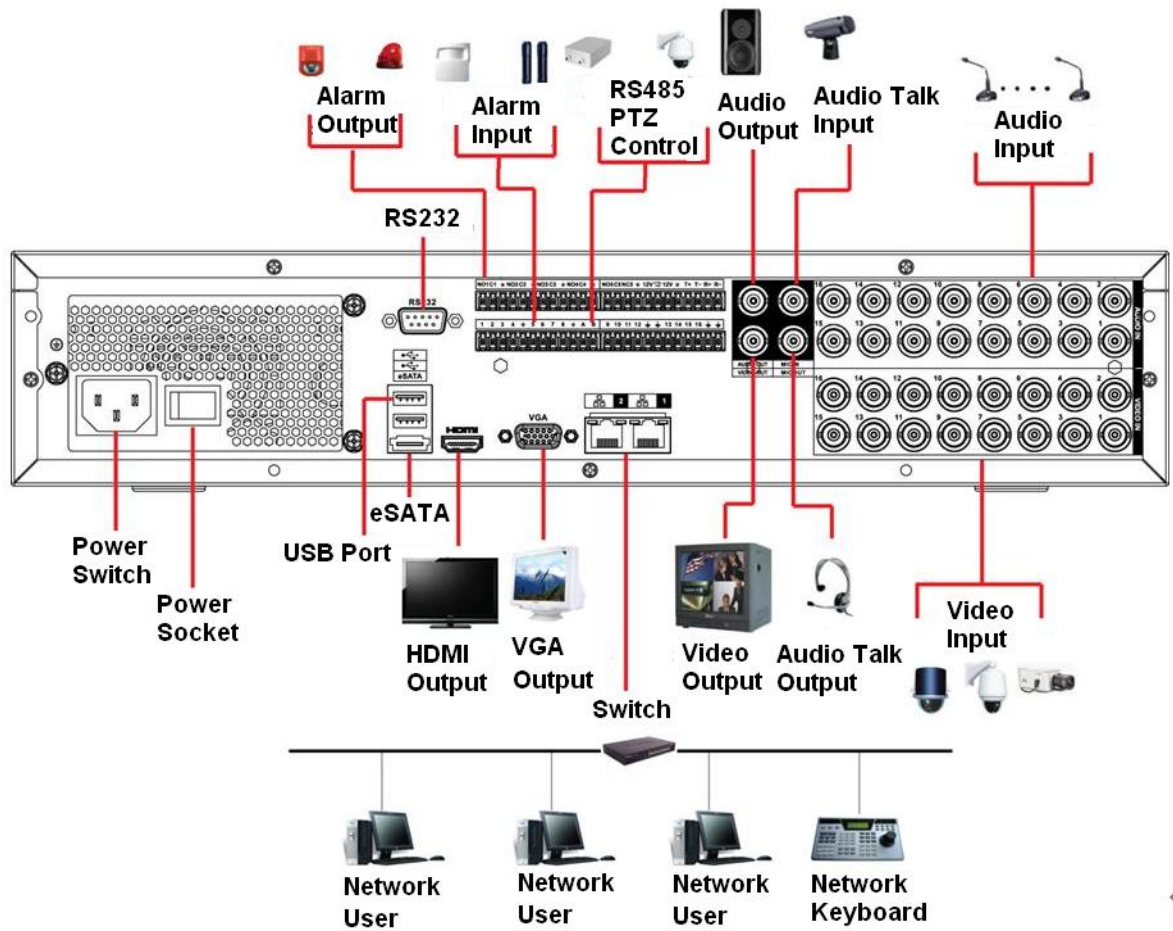

Figure 2-103

2.4 Remote Control

The remote control interface is shown as in Figure 2-104. Please note remote control is not our standard accessory and it is not included in the accessory bag.

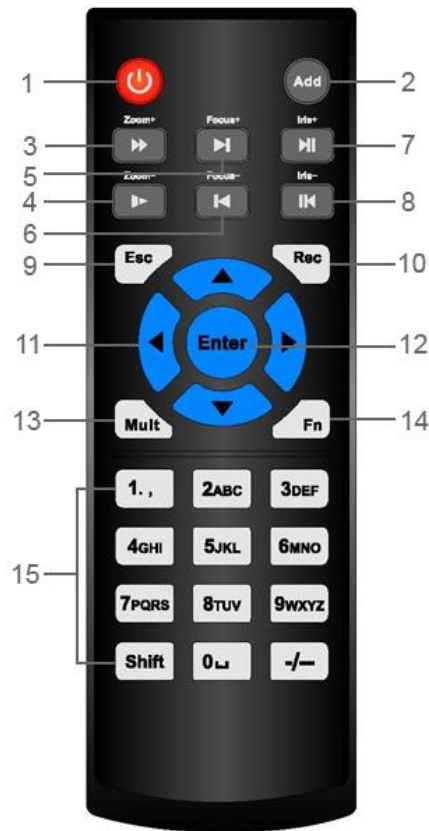



Figure 2-104

SN	Name	Function
1	Power button	Click it to boot up or shut down the device.
2	Address	Click it to input device number, so that you can control it.
3	Forward	Various forward speeds and normal speed playback.
4	Slow play	Multiple slow play speeds or normal playback.
5	Next record	In playback mode, playback the next video.
6	Previous record	In playback mode, playback the previous video.
7	Play/Pause	In pause mode, click this button to realize normal playback. In normal playback click this button to pause playback. In real-time monitor mode, click this button to enter video search menu.
8	Reverse/pause	Reverse playback pause mode, click this button to realize normal playback. In reverse playback click this button to pause playback.
9	Esc.	Go back to previous menu or cancel current operation (close upper interface or control)
10	Record	Start or stop record manually In record interface, working with the direction buttons to select the record channel. Click this button for at least 1.5 seconds, system can go to the Manual Record interface.

SN	Name	Function
11	Direction keys	Switch current activated control, go to left or right. In playback mode, it is to control the playback process bar. Aux function(such as switch the PTZ menu)
12	Enter /menu key	go to OK button go to the menu
13	Multiple-window switch	Switch between multiple-window and one-window.
14	Fn	In 1-ch monitor mode: pop up assistant function:PTZ control and Video color.
		Switch the PTZ control menu in PTZ control interface.
		In motion detection interface, working with direction keys to complete setup.
		In text mode, click it to delete character.
15	0-9 number key	Input password, channel or switch channel.
		Shift is the button to switch the input method.

2.5 Mouse Control

Left click mouse	System pops up password input dialogue box if you have not logged in. In real-time monitor mode, you can go to the main menu.
	When you have selected one menu item, left click mouse to view menu content.
	Implement the control operation.
	Modify checkbox or motion detection status.
	Click combo box to pop up drop down list

	<p>In input box, you can select input methods. Left click the corresponding button on the panel you can input numeral/English character (small/capitalized). Here ← stands for backspace button. _ stands for space button.</p> <p>In English input mode: _ stands for input a backspace icon and ← stands for deleting the previous character.</p>  <p>In numeral input mode: _ stands for clear and ← stands for deleting the previous numeral.</p> <p>When input special sign, you can click corresponding numeral in the front panel to input. For example, click numeral 1 you can input"/" , or you can click the numeral in the on-screen keyboard directly.</p> 
<p>Double left click mouse</p>	<p>Implement special control operation such as double click one item in the file list to playback the video.</p> <p>In multiple-window mode, double left click one channel to view in full-window.</p> <p>Double left click current video again to go back to previous multiple-window mode.</p>

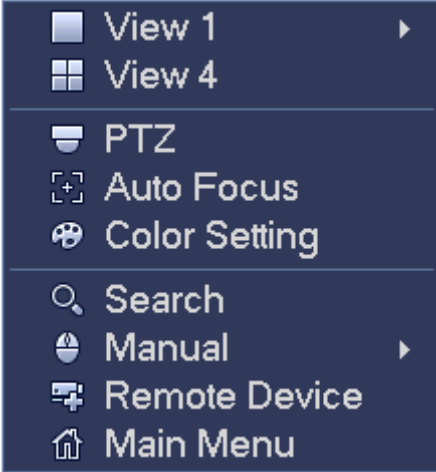
Right click mouse	<p>In real-time monitor mode, pops up shortcut menu: one-window, four-window, nine-window and sixteen-window, Pan/Tilt/Zoom, color setting, search, record, alarm input, alarm output, main menu. Among which, Pan/Tilt/Zoom and color setting applies for current selected channel.</p> <p>If you are in multiple-window mode, system automatically switches to the corresponding channel.</p> 
	Exit current menu without saving the modification.
Press middle button	<p>In numeral input box: Increase or decrease numeral value.</p> <p>Switch the items in the check box.</p> <p>Page up or page down</p>
Move mouse	Select current control or move control
Drag mouse	<p>Select motion detection zone</p> <p>Select privacy mask zone.</p>

2.6 Virtual Keyboard & Front Panel

2.6.1 Virtual Keyboard

The system supports two input methods: numeral input and English character (small and capitalized) input.

Move the cursor to the text column, the text is shown as blue, input button pops up on the right. Click that button to switch between numeral input and English input (capitalized and small), Use > or < to shift between small character and capitalized character.

2.6.2 Front Panel

Move the cursor to the text column. Click Fn key and use direction keys to select number you wanted. Please click enter button to input.

3 Installation and Connections

Note: All the installation and operations here should conform to your local electric safety rules.

3.1 Check Unpacked DVR

When you receive the DVR from the forwarding agent, please check whether there is any visible damage. The protective materials used for the package of the DVR can protect most accidental clashes during transportation. Then you can open the box to check the accessories.

Please check the items in accordance with the list. Finally you can remove the protective film of the DVR.



Note

Remote control is not a standard accessory and it is not included in the accessory bag.

3.2 About Front Panel and Rear Panel

The model in the front panel is very important; please check according to your purchase order.

The label in the rear panel is very important too. Usually we need you to represent the serial number when we provide the service after sales.

3.3 HDD Installation



Important

Shut down the device and then unplug the power cable before you open the case to replace the HDD!

All figures listed below for reference only!

This series DVR has 1 to 8 HDDs. Usually we do not recommend the HDD for the PC. You can refer to the Appendix for recommended HDD brand.

Please follow the instructions listed below to install hard disk.

3.3.1 Smart Box Series

Smart box includes HCVR5104C/HCVR51XXC-V2/HCVR71XXC-V2/

HCVR4104/4108C-S2/ HCVR5104 5108C-S2/ HCVR7104C-S2/ HCVR2108C-S2/

HCVR410XC-S3/HCVR510XC-S3/7104C-S3/

XVR410XC/XVR510XC/7104C/XVR51XXC-4M/ XVR41XXC-S2/ XVR51XXC-S2 Series.

Please make sure the metal surface of the HDD is facing up when you are installing!

This series product has only one 2.5-inch SATA HDD.

Please follow the instructions below to install HDD.



① Draw out the HDD bracket



② Make sure the HDD metal surface is facing up and then put the HDD into the bracket horizontally. After the HDD is in the proper position, the columns on the two sides can lock the screw holes of the HDD to secure it.



③ Put the HDD into the device.

When you remove the HDD, please refer to the following figure to pull the spring up and then remove the HDD.

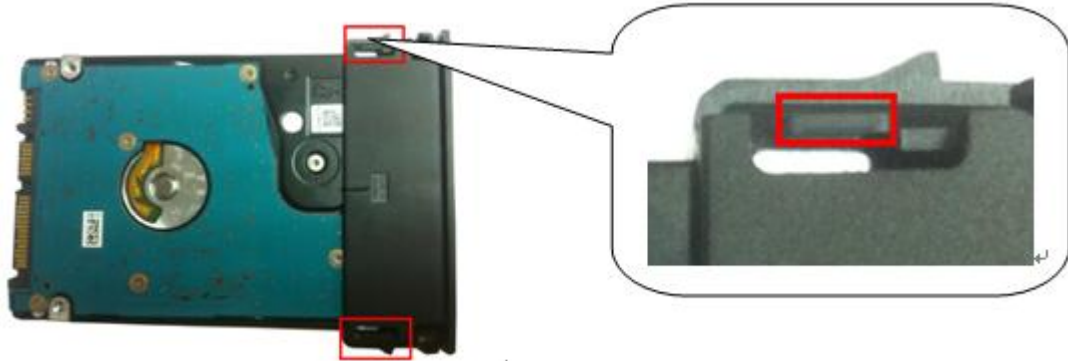

3.3.2 Smart 1U Series

The smart 1U series includes HCVR5104C/HCVR51XXC-V2/HCVR71XXC-V2/HCVR4104/4108C-S2/ HCVR5104 5108C-S2/ HCVR7104C-S2/ HCVR2108C-S2/XVR410XC/XVR510XC/7104C/XVR41XXC-S2/XVR51XXC-S2 series and etc.

The series DVR has one SATA HDD.



①. Loosen the screws of the upper cover and side panel.



② Fix four screws in the HDD (Turn just three rounds).



③ Place the HDD in accordance with the four holes in the bottom.



4 Turn the device upside down and then turn the screws in firmly.



5 Fix the HDD firmly.



6 Connect the HDD cable and power cable.



7 Put the cover in accordance with the clip and then place the upper cover back.



8 Secure the screws in the rear panel and the side panel.

3.3.3 Compact 1U and Mini 1U Series

- The mini 1U series includes HCVR51XXH/51XXHC/51XXHE/51XXH-V2/HC-V2/HE-V2/71XXH-V2/71XXHC-V2/71XXHE-V2/ HCVR41XXHE-S2/ HCVR51XXH-S2/ HCVR51XXHE-S2/ HCVR710XH-S2/HCVR710XHE-S2/XVR41XXHE/XVR51XXHE/XVR71XXH/XVR71XXHE/HCVR710XH-4K/XVR51XXH-S2/XVR51XXHE-S2/XVR5108H-4KL-8P and etc.
- The compact 1U series includes HCVR41XXHS-S2/HCVR2108HS-S2/HCVR2116HS-S2/HCVR21XXHS-S2/XVR21XXHS/XVR41XXHS/51XXHS/7104HS/XVR41XXHS-S2/ XVR51XXHS-S2 and etc.

The series DVR has one SATA HDD.



1 Loosen the screws of the upper cover and side panel.



2 Fix four screws in the HDD (Turn just three rounds).



3 Place the HDD in accordance with the four holes in the bottom.

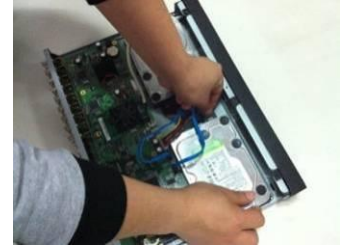
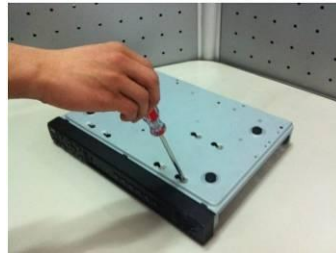
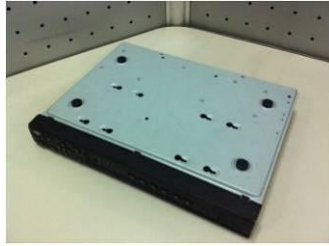

④ Turn the device upside down and then turn the screws in firmly.

⑤ Fix the HDD firmly.

⑥ Connect the HDD cable and power cable.



⑦ Put the cover in accordance with the clip and then place the upper cover back.

⑧ Secure the screws in the rear panel and the side panel.

Important:

- You can connect the HDD data cable and the power cable first and then fix the HDD in the device.
- Please pay attention to the front cover. It adopts the vertical sliding design. You need to push the clip first and then put down.

3.3.4 The 1U Series

The 1U series includes

HCVR52XXA-V2/HCVR72XXA-V2/HCVR42XXA-S2/HCVR4216AN-S2/HCVR52XXA-S2/HCVR5216AN-S2/HCVR720XA-S2/XVR42XXA/XVR4216AN/XVR52XXA/XVR5216AN/XVR72XXA/XVR7216AN/HCVR720XAN-4K/XVR42XXA-S2/XVR42XXAN-S2/XVR52XXA-S2/ XVR52XXAN-S2/ XVR5208AN-4KL-8P/XVR5216AN-4KL-16P and etc.

This series DVR has two SATA HDDs.



① Loosen the screws of the upper ② Fix four screws in the HDD ③ Place the HDD in accordance

cover and side panel. Remove (Turn just three rounds). the cover.



with the four holes in the bottom.



④ Turn the device upside down and then turn the screws in firmly.

⑤ Connect the HDD cable and power cable.

⑥ Put the cover in accordance with the clip and then place the upper cover back. Secure the screws in the rear panel and the side panel.

3.3.5 The 1.5U Series

The 1.5U series includes HCVR52XXL-V2/

HCVR54XXL-V2/HCVR44L-S2/XVR54XX-L/XVR74XX-L and etc.

This series DVR max has four SATA HDDs. Please use HDD of 7200rpm or higher.



① Loosen the screws of the upper cover. Remove the cover.

② Line up the HDD to the four holes of the HDD bracket. Use four screws to fix HDD.

③ Connect the one end of the HDD cable to the HDD.

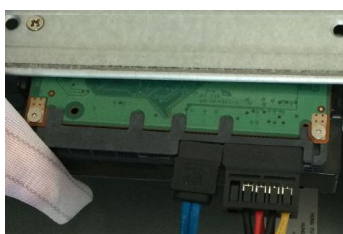

④ Connect the other end of the HDD cable to the mainboard.

⑤ Connect the power cable to the HDD.

⑥ Put the cover back and fix the screws to secure firmly.

3.3.6 The 2U Series

The 2U series includes HCVR58XXS-V2/HCVR48XXS-V2/XVR54XX-S/XVR74XX-S and

etc.

This series DVR max supports 8 SATA HDDs. Please use HDD of 7200rpm or higher.



① Loosen the screws of the upper cover and side panel. Remove the cover.



② Fix the HDD(s) on the bracket. Remove the top bracket if you want to install HDD to the bottom bracket.



③ Connect the one end of the HDD cable to the HDD.

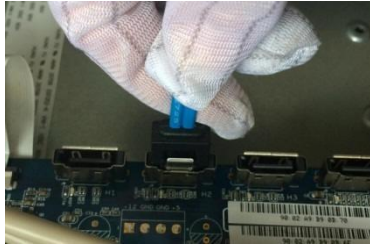

④ Connect the other end of the HDD cable to the mainboard.

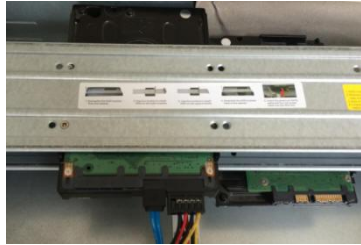

⑤ Connect the power cable to the HDD.



⑥ Put the cover back and fix the screws to secure firmly.

Important:

If the HDD amount is less than four, you do not need to install the HDD bracket.

When there is a bracket, please make sure the installation direction of HDDs is the same.

3.3.7 Cooper 1U Series



① Loosen the screws of the upper cover and side panel.



② Connect SATA cable and SATA power cable to the HDD. Fix four screws in the HDD (Turn just three rounds).



③ Place the HDD in accordance with the four holes in the bottom.



④ Turn the device upside down and then turn the screws in firmly.

⑤ Connect the SATA cable and SATA power cable to the main board.

⑥ Put the cover in accordance with the clip and then place the upper cover back. Secure the screws in the rear panel and the side panel.



Note

You can connect the HDD data cable and the power cable first and then fix the HDD in the device.

3.3.8 Rack Installation

The DVR occupies 1.5U/2U rack units of vertical rack space.

- Use twelve screws to fix the unit
- Please make sure the indoor temperature is below 35°C (95°F).
- Please make sure there is 15cm (6 inches) space around the device to guarantee sound ventilation.
- Please install from the bottom to the top.
- If there are more accessories connected in the rack, please take precaution measures in case the rack power is overload.

3.4 Connecting Power Supply

Please check input voltage and device power button match or not.

We recommend you use UPS to guarantee steady operation, DVR life span, and other peripheral equipments operation such as cameras.

3.5 Connecting Video Input and Output Devices

3.5.1 Connecting Video Input

The video input interface is BNC. The input video format includes: PAL/NTSC BNC (1.0V_{P-P}, 75Ω) .

The input video format: BNC (0.8VP-P,75Ω) ,

The video signal should comply with your national standards.

The input video signal shall have high SNR, low distortion; low interference, natural color and suitable lightness.

Guarantee the stability and reliability of the camera signal:

The camera shall be installed in a cool, dry place away from direct sunlight, inflammable, explosive substances and etc.

The camera and the DVR should have the same grounding to ensure the normal operation of the camera.

Guarantee stability and reliability of the transmission line.

Please use high quality, sound shielded BNC. Please select suitable BNC model according to the transmission distance.

If the distance is too long, you should use twisted pair cable, and you can add video compensation devices or use optical fiber to ensure video quality.

You should keep the video signal away from the strong electromagnetic interference, especially the high tension current.

Keep connection lugs in well contact.

The signal line and shielded wire should be fixed firmly and in well connection. Avoid dry joint, lap welding and oxidation.

3.5.2 Connecting Video Output

Video output includes a BNC(PAL/NTSC, 1.0VP- P, 75Ω) output, a VGA output and a HDMI output.

System supports BNC, VGA and HDMI output at the same time.

When you are using pc-type monitor to replace the monitor, please pay attention to the following points:

- To defer aging, do not allow the pc monitor to run for a long time.
- Regular demagnetization will keep device maintain proper status.
- Keep it away from strong electromagnetic interference devices.

Using TV as video output device is not a reliable substitution method. You also need to reduce the working hour and control the interference from power supply and other devices. The low quality TV may result in device damage.

3.6 Connecting Audio Input & Output, Bidirectional Audio

3.6.1 Audio Input

BNC port is adopted for audio input port.

Due to high impedance of audio input, please use active sound pick-up.

Audio transmission is similar to video transmission. Try to avoid interference, dry joint, loose contact and it shall be away from high tension current.

3.6.2 Audio Output

The audio output signal parameter is usually over 200mv 1KΩ (BNC). It can directly connect to low impedance earphone, active sound box or amplifier-drive audio output device.

If the sound box and the pick-up cannot be separated spatially, it is easy to arouse squeaking. In this case you can adopt the following measures:

- Use better sound pick-up with better directing property.
- Reduce the volume of the sound box.
- Using more sound-absorbing materials in decoration can reduce voice echo and improve acoustics environment.
- Adjust the layout to reduce happening of the squeaking.

3.7 Alarm Input and Output Connection

Please read the followings before connecting.

1. Alarm input

- Please make sure alarm input mode is grounding alarm input.
- Grounding signal is needed for alarm input.
- Alarm input needs the low level voltage signal.
- Alarm input mode can be either NC (normal Open) or NO (Normal Close)
- When you are connecting two DVRs or you are connecting one DVR and one other device, please use a relay to separate them,

2. Alarm output

The alarm output port should not be connected to high power load directly (It shall be less than 1A) to avoid high current which may result in relay damage. Please use the contactor to realize the connection between the alarm output port and the load.

3. How to connect PTZ decoder

- Ensure the decoder has the same grounding with DVR, otherwise you may not control the PTZ. Shielded twisted wire is recommended and the shielded layer is used to connect to the grounding.
- Avoid high voltage. Ensure proper wiring and some thunder protection measures.
- For too long signal wires, 120Ω should be parallel connected between A, B lines on the far end to reduce reflection and guarantee the signal quality.
- “485 A, B” of DVR cannot parallel connect with “485 port” of other device.
- The voltage between of A,B lines of the decoder should be less than 5v.

4. Please make sure the front-end device has soundly earthed.

Improper grounding may result in chip damage.

3.7.1 Alarm Input and Output Details

Important

Please refer to the specifications for the alarm input and output channel amount. Do not merely count the alarm input and out channel amount according to the ports on the rear panel.

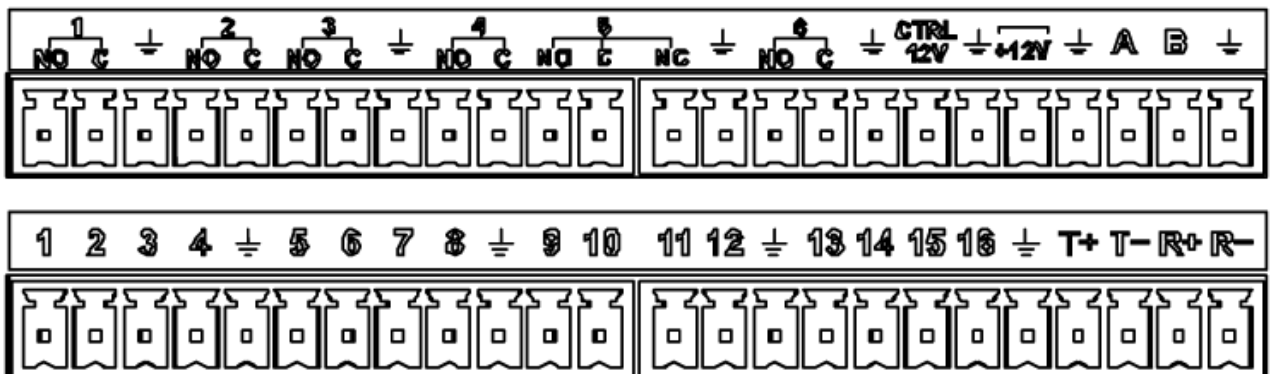



Figure 3-1

1,2,3,4,5,6,7,8,9,10,11,12,13,14,15,16	ALARM 1 to ALARM 16. The alarm becomes active in low voltage.
In the second line, from the left to the right: NO1 C1, NO2 C2, NO3 C3, NO4 C4, NO5 C5, NO6 C6.	There are six groups of normal open activation output (on/off button)
CTRL 12V	Control power output. For external alarm, you need to close the device power to cancel the alarm. Voltage current; 500mA.
+12V	Rated current. Voltage current; 500mA.
	Earth cable.
485 A/B	485 communication port. They are used to control devices such as decoder. 120Ω should be parallel connected between A, B lines if there are too many PTZ decoders.
T+,T-,R+,R-	They are four-wire full-duplex RS485 port T+ T-: output wire R+ R-: input wire

3.7.2 Alarm Input Port

Please refer to the following sheet for more information.

- Grounding alarm inputs. Normal open or Normal close type)
- Please parallel connect COM end and GND end of the alarm detector (Provide external power to the alarm detector).
- Please parallel connect the Ground of the DVR and the ground of the alarm detector.
- Please connect the NC port of the alarm sensor to the DVR alarm input(ALARM)
- Use the same ground with that of DVR if you use external power to the alarm device.

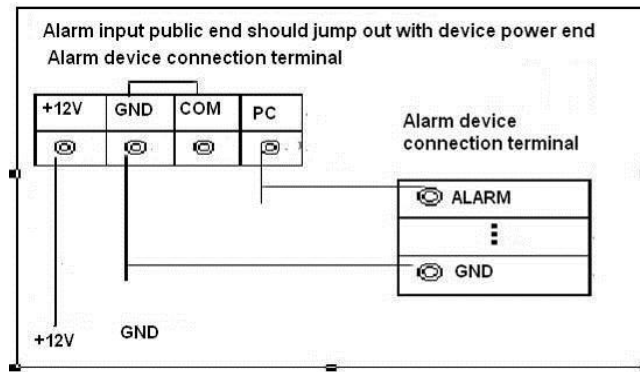

Figure 3-2

3.7.3 Alarm Output Port

- Provide external power to external alarm device.
- To avoid overloading, please read the following relay parameters sheet carefully.
- RS485 A/B cable is for the A/B cable of the PTZ decoder.
- T+,T-,R+,R- are four-wire double duplex RS485 port.
T+ T-: output wire
R+ R-: input wire

Relay Specification

Model		HFD23/005-1ZS	HRB1-S-DC5V
Material of the touch		AgNi+ gold-plating	AuAg10/AgNi10/CuNi30
Rating (Resistance Load)	Rated switch capacity	30V DC 1A/125V AC 0.5A	24V DC 1A/125V AC 2A
	Maximum switch power	62.5VA/30W	250VA/48W
	Maximum switch voltage	125V AC/60V DC	125V AC/60V DC
	Maximum switch current	2A	2A
Insulation	Between touches	400VAC 1 minute	500VAC 1 minute
	Between touch and winding	1000VAC 1 minute	1000VAC 1 minute
Turn-on Time		5ms max	5ms max
Turn-off Time		5ms max	5ms max
Longevity	Mechanical	1×10 ⁷ times (300 times/MIN)	5×10 ⁶ times (300 times/MIN)
	Electrical	1×10 ⁵ times (30 times/MIN)	2.5×10 ⁴ times (30 times/MIN)
Working Temperature		-30°C~+70°C	-40°C~+70°C

3.8 RS485

When the DVR receives a camera control command, it transmits that command up the coaxial cable to the PTZ device. RS485 is a single-direction protocol; the PTZ device can't return any data to the unit. To enable the operation, connect the PTZ device to the RS485 (A,B) input on the DVR.

Since RS485 is disabled by default for each camera, you must enable the PTZ settings first. This series DVRs support multiple protocols such as Pelco-D, Pelco-P.

To connect PTZ devices to the DVR:

1. Connect RS485 A,B on the DVR rear panel.
2. Connect the other end of the cable to the proper pins in the connector on the camera.
3. Please follow the instructions to configure a camera to enable each PTZ device on the DVR.

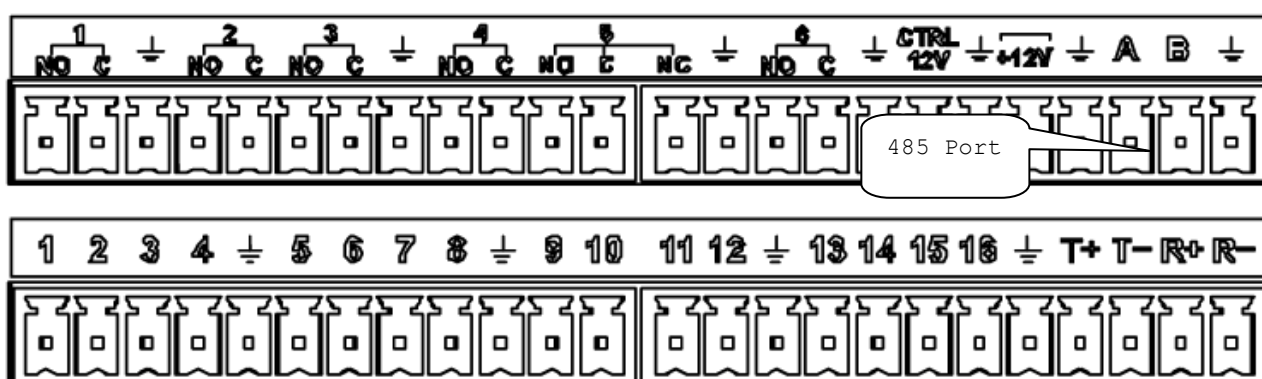

Figure 3-3

3.9 Other Interfaces

There are still other interfaces on the DVR, such as USB port.

4 Overview of Navigation and Controls



Note

- The figures listed in the following chapters for reference only. Refer to the actual product for detailed information. The operations are the same.
- For some functions, please left click mouse to enter the menu contents and right click menu to go back to the previous menu. Refer to chapter 2.5 Mouse control for detailed information.

4.1 Initial Settings

4.1.1 Boot up



WARNING

- The rated input voltage matches the device power on-off button. Please make sure the power wire connection is OK. Then click the power on-off button.
- To protect device, please connect device to the power adapter first and then connect the power cable.
- Always use the stable current, if necessary UPS is a best alternative measure.

Please follow the steps listed below to boot up the device.

Step 1 Connect the device to the monitor and then connect a mouse.

Step 2 Connect power cable.

Step 3 Click the power button at the front or rear panel and then boot up the device.
After device booted up, the device is in multiple-channel display mode by default.
If the boot up time is in the record period, the device automatically goes to auto record mode, the corresponding channel indicator light is on, and device is working properly.

4.1.2 Device Initialization

If it is your first time to use the device, please set a login password of **admin** (system default user).



Note

For your device safety, please keep your login password of **admin** well after the initialization steps, and change the password regularly.

Steps:

Step 1 Boot up device.

Device displays device initialization interface. See Figure 4-1.



Figure 4-1

Step 2 Set login password of **admin**.

- User name: The default user name is **admin**.
- Password/confirm password: The password ranges from 8 to 32 digitals. It can contain letters, numbers and special characters (excluding “” , “” , “ , ” , “ . ” , “ & ”) . The password shall contain at least two categories. Usually we recommend the strong password.
- Prompt question: If you set the prompt question here. On the login interface, click , device can display the corresponding prompt question for you to remind the password.



WARNING

STRONG PASSWORD RECOMMENDED-For your device own safety, please create a strong password of your own choosing. We also recommend you change your password periodically especially in the high security system.

Step 3 Click Next.

Device goes to unlock pattern interface. See Figure 4-2.

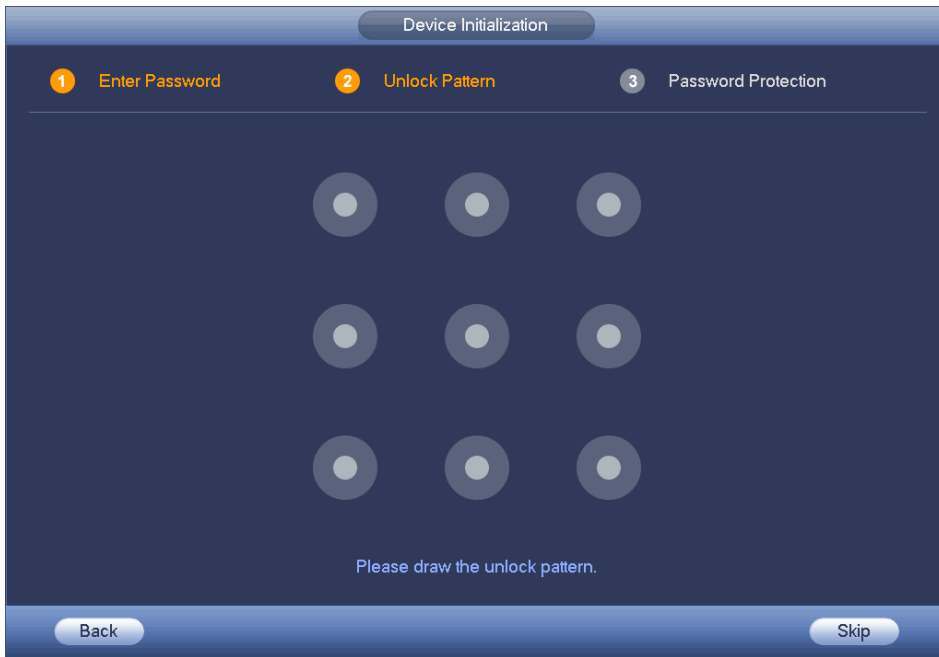

Figure 4-2

Step 4 Set unlock pattern.

After set unlock pattern, device goes to password protection interface. See Figure 4-3.

 **Note**

- The unlock pattern shall at least contain 4 grids.
- Device adopts unlock pattern to login by default if you have set pattern here. If there is no unlock pattern, please input the password to login.
- Click Skip if there is no need to set unlock pattern.

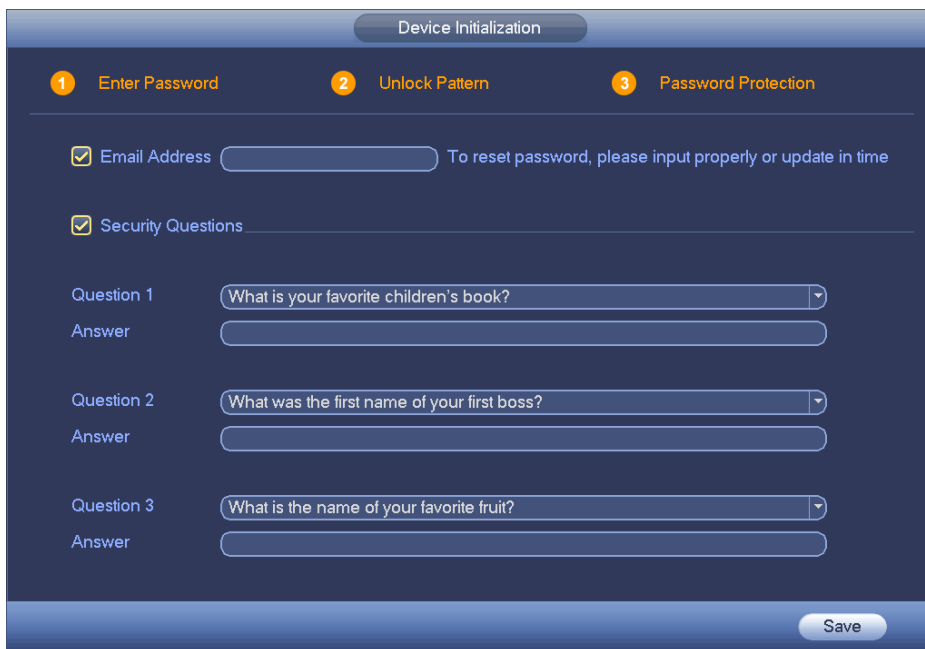

Figure 4-3

Step 5 Set security questions.



Note

- After setting the security questions here, you can use the email you input here or answer the security questions to reset admin password. Refer to chapter 4.1.3 Reset password for detailed information.
- Cancel the email or security questions box and then click Next button to skip this step.
- Email: Input an email address for reset password purpose. In case you forgot password in the future, input the security code you got on the assigned email to reset the password of admin. If you have not input email here or you need to update the email information, please go to the main menu->Setting->System->Account to set.
- Security question: Set security questions and corresponding answers. Properly answer the questions to reset admin password. In case you have not input security question here or you need to update the security question information, please go to the main menu->Setting->System->Account to set.

Step 6 Click OK to complete the device initialization setup.

Device goes to startup wizard interface. Refer to chapter 4.1.4 Quick Settings for detailed information.

4.1.3 Reset Password

If you forgot **admin** login password, there are two ways for you to reset password.

- When password reset function is enabled, scan the QR code on the user interface and use the email to reset password.
- When the password reset function is disabled, answer the security questions to reset password. If you have not set security questions, system pops up “Password reset function has been disabled” dialogue box, please use the Reset button on the mainboard to restore factory default settings.

Steps:

Step 1 Go to the device login interface. See Figure 4-4 or Figure 4-5. .

- If you have set unlock pattern, device displays unlock pattern login interface. See Figure 4-4. Click “Forgot unlock pattern”, device goes to Figure 4-5.
- If you have not set unlock pattern, device displays password interface. See Figure 4-5.



Note

Click Switch user button in Figure 4-4 or click the user name in Figure 4-5 and then select a user from the dropdown list, you can login via other account.

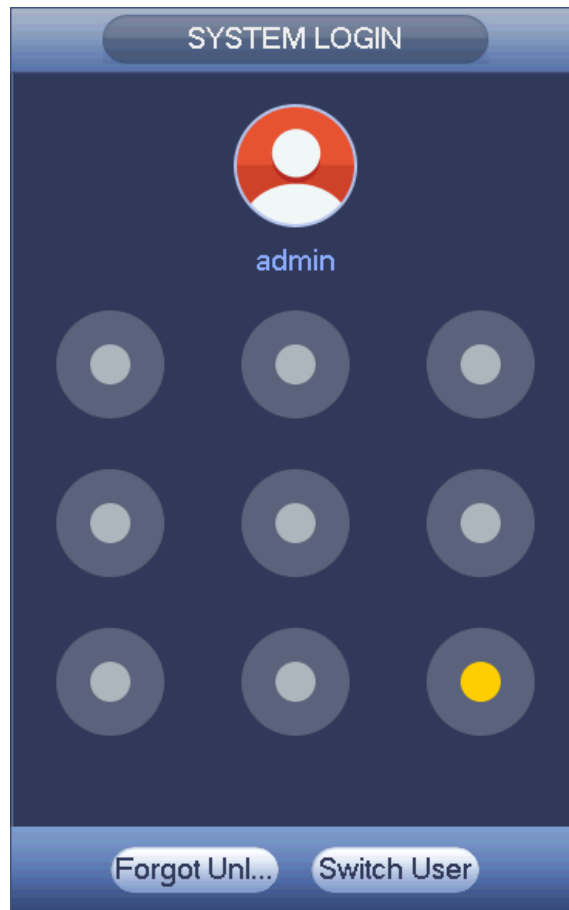



Figure 4-4



Figure 4-5

- Step 2 Click  or click Forgot password on the login interface (Figure 4-5).
- If you have input email when you are initializing the device, device goes to Figure 4-6.
 - If you have not input email address information when you are initializing the

device, the interface is shown as in Figure 4-7.

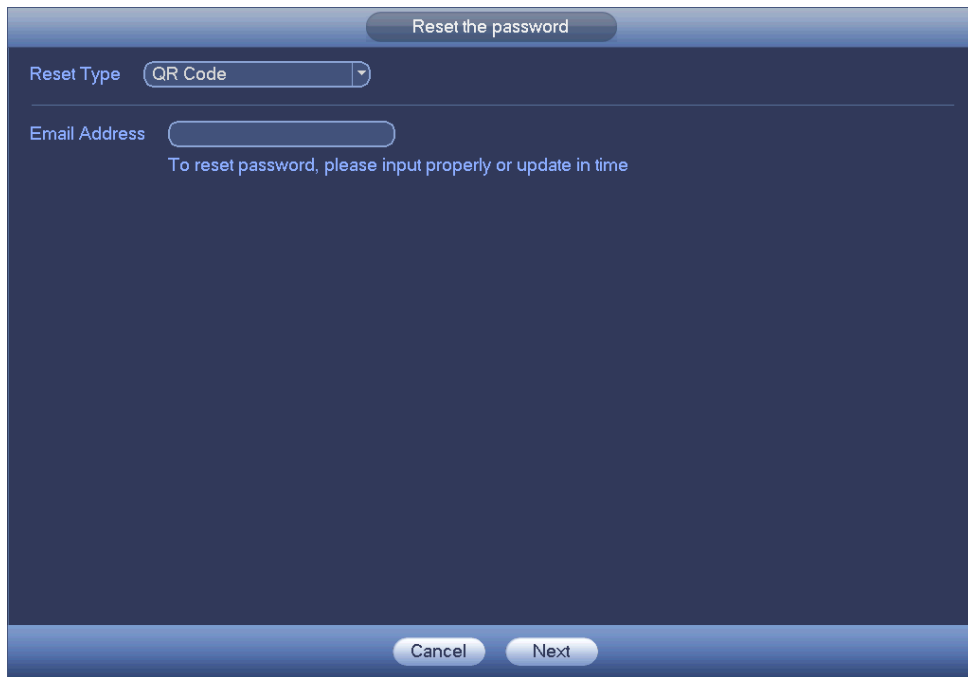

Figure 4-6

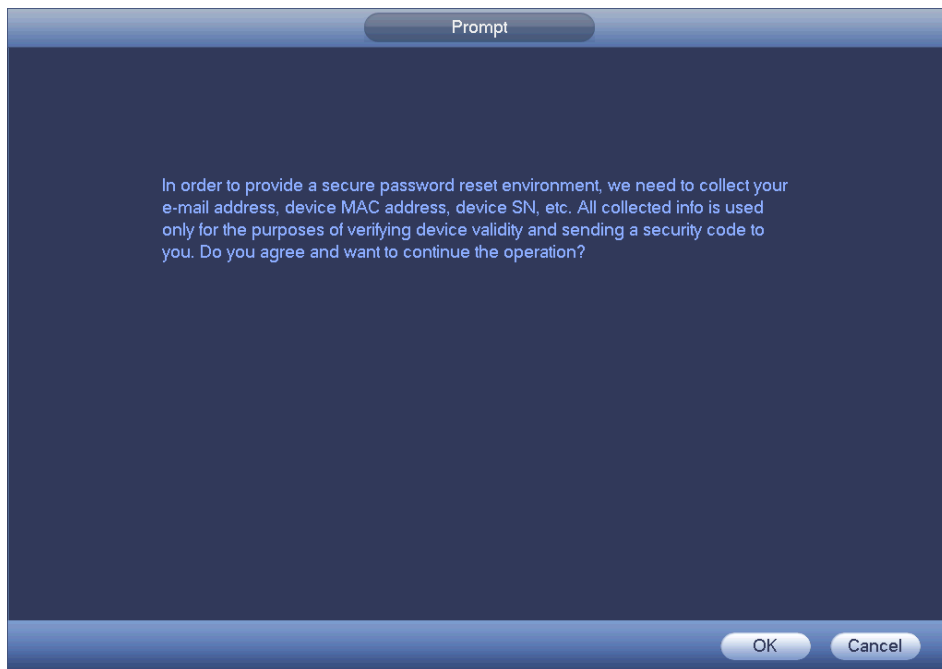

Figure 4-7

- Step 3 Input an email address and then click Next button.
Enter reset password interface. See Figure 4-8.

 **Note**

Click Next, we are going to collect your information for reset password purpose.
The collected information includes but not limited to your cellphone number,

device MAC address, device SN. Please read the the notice carefully and make sure you agree to our information collection operation.

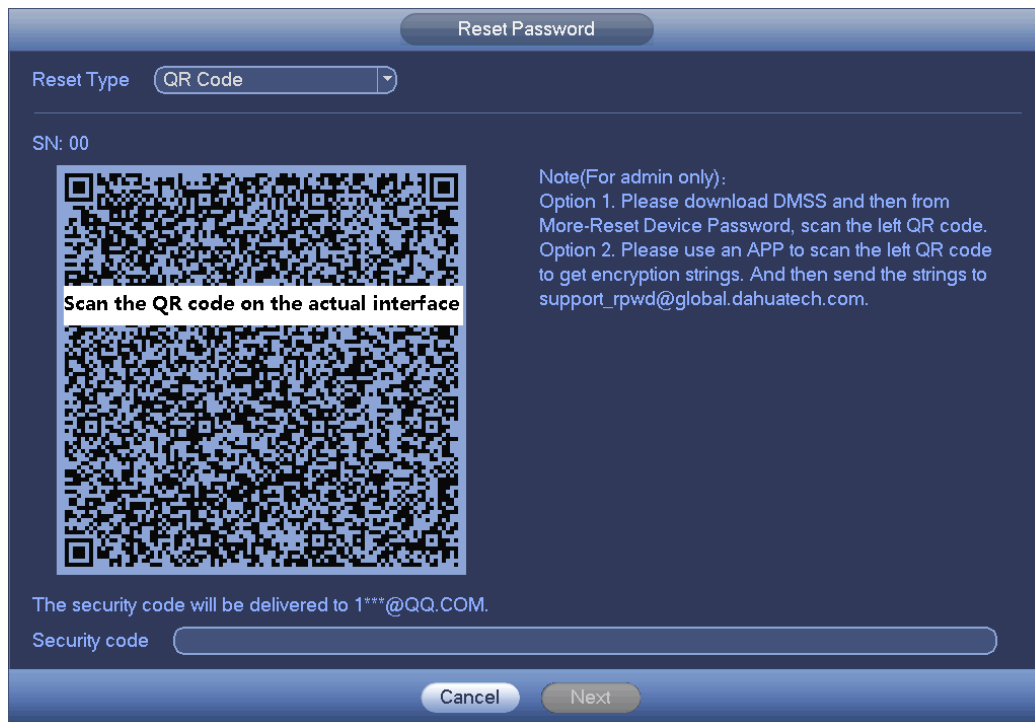

Figure 4-8

Step 4 Reset login password.

There are two ways to reset the password: Scan QR code and reset by email/security questions (local menu only)

- Email

In Figure 4-8, follow the prompts on the interface to scan the QR code, and then input the security code you get via the assigned email.



WARNING

- ✧ For the same QR code, max scan twice to get two security codes. Refresh the QR code if you want to get security code again.
- ✧ The security code on your email is only valid for 24 hours.

- Security questions

In Figure 4-7, select security question from the drop down list. Device displays security question interface. See Figure 4-9. Please input the correct answers here.



Note

There is no security question item from the dropdown list if you have not set the security question and corresponding answers when initializing the device.

Reset the password

Reset Type: Security Questions

Question 1: What is your favorite children's book?
Answer:

Question 2: What was the first name of your first boss?
Answer:

Question 3: What is the name of your favorite fruit?
Answer:

Cancel Next

Figure 4-9

Step 5 Click Next button.

Device displays reset password interface. See Figure 4-10.

Reset the password

Reset password of (admin)

New Password:

Use a password that has 8 to 32 characters, it can be a combination of letter(s), number(s) and symbol(s) with at least two kinds of them.(please do not use special symbols like ' " ; : &)

Confirm Password:

Cancel Save

Figure 4-10

Step 6 Input new password and then confirm.



WARNING

STRONG PASSWORD RECOMMENDED-For your device own safety, please create a strong password of your own choosing. The password shall be at least 8-digit containing at least two types of the following categories: letters, numbers and symbols. We also recommend you change your password periodically especially in the high security system.

Step 7 Click Save button to complete the reset setup.

Device pops up dialogue box asking you to sync the password to the camera connecting by the default protocol. See Figure 2-32. Click OK to change the camera password. See Figure 2-33.



Note

The following dialogue pops up if there is a digital channel.

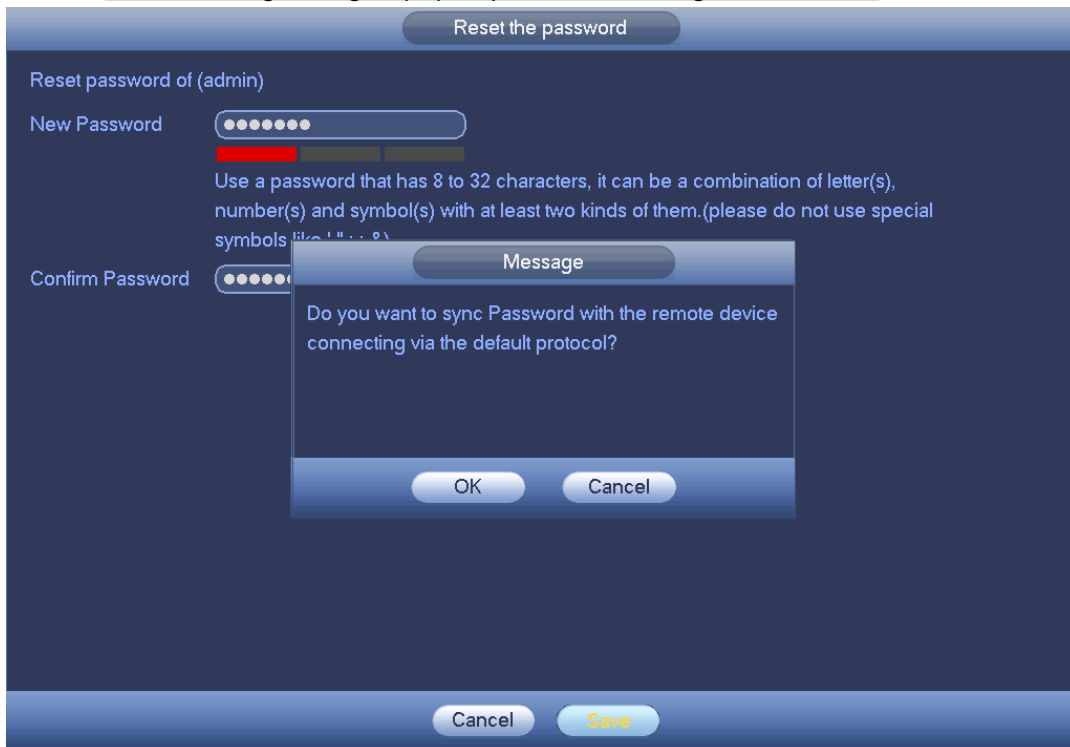

Figure 4-11



Figure 4-12

4.1.4 Quick Settings

The startup wizard and the configuration wizard can guide you to complete the basic settings so that the device can work properly.

- Startup wizard: After initialize the device, system goes to the End-User License Agreement (EULA) interface. See Figure 4-13. Check the box to agree the EULA. Click Next button to enter startup wizard if it is your first time to login. See Figure 4-14.



Figure 4-13

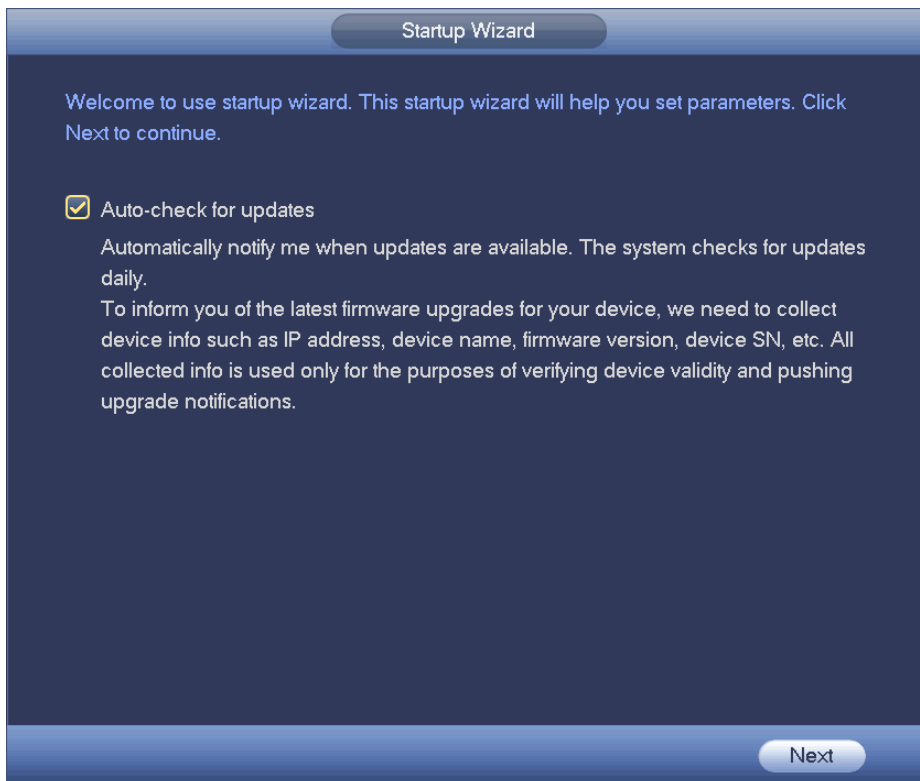

Figure 4-14

- Configuration wizard: On the preview interface, right click mouse and then click configuration wizard. The setting items are the same as the startup wizard.



Note

- Check the Auto-check for updates button, system automatically checks updates every day and automatically pops up information once any updates are available.
- After enabling Auto-check for updates box, we are going to collect device information including but not limited to device IP address, device name, device firmware, device SN. The collected information is only to verify device validity and push notice to you.
- Cancel Auto-check for updates, system does not automatically check the updates are available or not.

4.1.4.1 General

Besides startup wizard and configuration wizard, from main menu->Setting->System->General, you can also go to the General interface too.

4.1.4.1.1 General

Step 1 Click General tab.

Enter General interface. See Figure 4-15.

Step 2 Set parameters.

- Device ID: Please input a corresponding device name here.
- Device No: Here you can set device number.
- Language: System supports various languages: Chinese (simplified), Chinese (Traditional), English, Italian, Japanese, French, Spanish (All languages listed here are optional. Slight difference maybe found in various series.)
- Video standard: There are two formats: NTSC and PAL.
- Instant playback: It is to set playback time you can view in the preview interface. The value ranges from 5 to 60 minutes.
- Auto logout: Here is for you to set auto logout interval once login user remains inactive for a specified time. Value ranges from 0 to 60 minutes.
- Monitor channels when logout: Here you can set channels you want to view when your account has logged out. Click the button and then cancel the channel name box, you need to login to view the corresponding video. The channel window displays  in preview interface.
- IPC Time Sync: You can input an interval here to synchronize the DVR time and IPC time.
- Navigation bar: Check the box here, system displays the navigation bar on the interface.
- Mouse sensitivity: You can set double click speed via dragging the slide bard. You can Click Default button to restore default setup.



Figure 4-15

Step 3 Click Apply or Save to complete setup.

4.1.4.1.2 Date and Time

Step 1 Click Date and Time tab.

Enter date and time interface. See Figure 4-16.

Step 2 Set parameters.

- Date format: There are three types: YYYY-MM-DD: MM-DD-YYYY or DD-MM-YYYY.
- Date separator: There are three denotations to separate date: dot, beeline and solidus.
- DST: Here you can set DST time and date. Here you can set start time and end time by setting corresponding week setup or by setting corresponding date setup.
- NTP: It is to set NTP server information. Check the NTP box to enable this function.
- ✧ Host IP: Input the server IP that installed the NTP server.
- ✧ Manual update: Click it, you can sync DVR time with the NTP server manually.
- ✧ Port: System supports TCP transmission only. The port value is 123.
- ✧ Interval: It is to set the sync time interval between the DVR and the NTP server. The value ranges from 0 to 65535 minutes.



Figure 4-16

Step 3 Click Apply or Save to complete setup.

4.1.4.1.3 Holiday

Step 1 Click Holiday tab.

Enter holiday interface. See Figure 4-17.

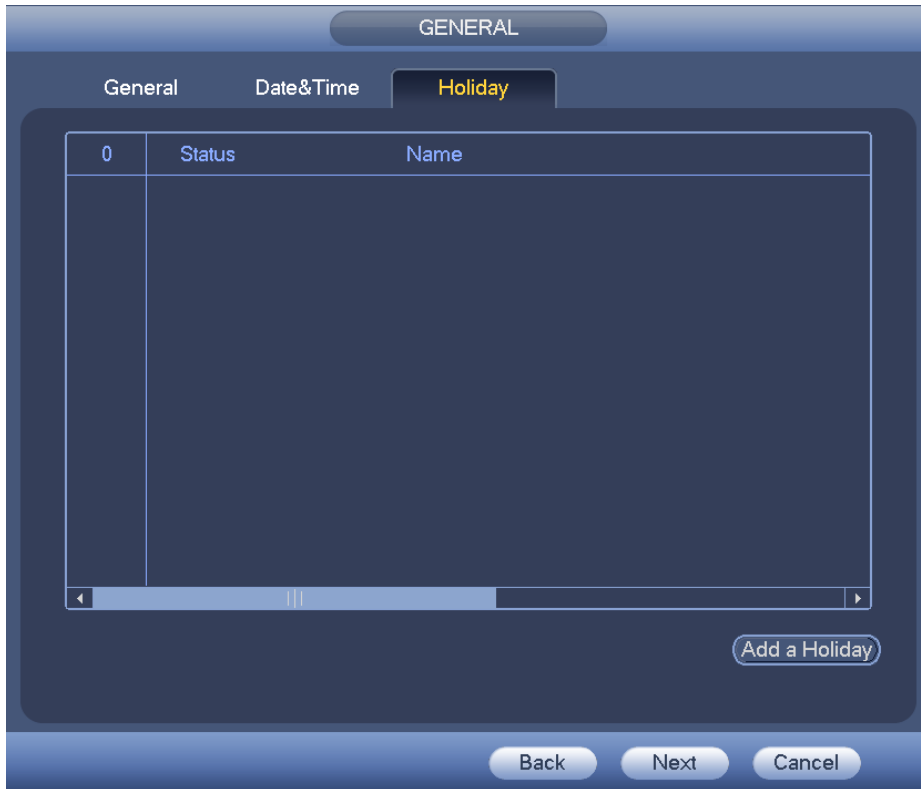

Figure 4-17

- Step 2 Click Add new holiday button.
 Enter Add new holiday interface. See Figure 4-18.



Figure 4-18

- Step 3 Input new holiday information. It is to set holiday name, repeat mode and start/end time.



Note



Click Add more to add more holidays if necessary.

Step 4 Click Add button.

Device goes back to Figure 4-17 to display the new holiday.



Note

- The new holiday state is on by default. Select from the dropdown list to disable.
- Drag the slide bar, click  to edit holiday, click  to delete holiday.



Note

After successfully set holiday here, you can view holiday item in Schedule interface. It is for you to set holiday schedule record/snapshot settings.

4.1.4.2 Network

Before the operation, make sure the device has properly connected the network cable.

Besides startup wizard and configuration wizard, from main

menu->Setting->Network->TCP/IP, you can also go to the network interface.

Step 1 From main menu->Setting->Network->TCP/IP.

Enter TCP/IP interface. See Figure 4-19.

Step 2 Set parameters.

● Network Mode: Includes multiple access, fault tolerance, and load balancing. **Please note the network mode is not for product of single-Ethernet card.**

- ◇ Multiple-address mode: eth0 and eth1 operate separately. You can use the services such as HTTP, RTP service via eth0 or the eth1. Usually you need to set one default card (default setup is eth0) to request the auto network service from the device-end such as DHCP, email, FTP and etc. In multiple-address mode, system network status is shown as offline once one card is offline.
- ◇ Network fault-tolerance: In this mode, device uses bond0 to communicate with the external devices. You can focus on one host IP address. At the same time, you need to set one master card. Usually there is only one running card (master card). System can enable alternate card when the master card is malfunction. The system is shown as offline once these two cards are both offline. Please note these two cards shall be in the same LAN.
- ◇ Load balance: In this mode, device uses bond0 to communicate with the external device. The eth0 and eth1 are both working now and bearing the network load. Their network load are general the same. The system is shown as offline once these two cards are both offline. Please note these two cards shall be in the same LAN.
- Default Network Card: Please select eth0/eth1/bond0(optional) after enable multiple-access function
- Main Network Card: Please select eth0/eth1 (optional).after enable multiple

access function.

Note: Some series support the above three configurations and supports functions as multiple-access, fault-tolerance and load balancing.

- IP Version: There are two options: IPv4 and IPv6. Right now, system supports these two IP address format and you can access via them.
- MAC address: The host in the LAN can get a unique MAC address. It is for you to access in the LAN. It is read-only.
- IP address: Here you can use up/down button (▲▼) or input the corresponding number to input IP address. Then you can set the corresponding subnet mask the default gateway.
- Default gateway: Here you can input the default gateway. Please note system needs to check the validity of all IPv6 addresses. The IP address and the default gateway shall be in the same IP section. That is to say, the specified length of the subnet prefix shall have the same string.
- DHCP: It is to auto search IP. When enable DHCP function, you cannot modify IP/Subnet mask /Gateway. These values are from DHCP function. If you have not enabled DHCP function, IP/Subnet mask/Gateway display as zero. You need to disable DHCP function to view current IP information. Besides, when PPPoE is operating, you cannot modify IP/Subnet mask /Gateway.
- MTU: It is to set MTU value of the network adapter. The value ranges from 1280-7200 bytes. The default setup is 1500 bytes. Please note MTU modification may result in network adapter reboot and network becomes off. That is to say, MTU modification can affect current network service. System may pop up dialog box for you to confirm setup when you want to change MTU setup. Click OK button to confirm current reboot, or you can click Cancel button to terminate current modification. Before the modification, you can check the MTU of the gateway; the MTU of the DVR shall be the same as or is lower than the MTU of the gateway. In this way, you can reduce packets and enhance network transmission efficiency.

The following MTU value is for reference only.

- ◇ 1500: Ethernet information packet max value and it is also the default value. It is the typical setup when there is no PPPoE or VPN. It is the default setup of some router, switch or the network adapter.
- ◇ 1492: Recommend value for PPPoE.
- ◇ 1468: Recommend value for DHCP.
- ◇ 1450: Recommend value for VPN.
- Preferred DNS server: DNS server IP address.
- Alternate DNS server: DNS server alternate address.



Figure 4-19

Step 3 Click Apply or Save to complete setup.

4.1.4.3 P2P

You can add a device via the client on the cellphone or the platform.

- You can use your cell phone to scan the QR code and add it to the cell phone client.
- Go to the P2P management platform, via the SN from scanning the QR code, you can access the device in the WAN. Please refer to the P2P operation manual.

Besides startup wizard and configuration wizard, from main

menu->Setting->Network->P2P, you can also go to the P2P interface. See Figure 4-20.

Check the box to enable P2P function, and status is online. Cell phone or the platform can add and access the device.

Note

After you enable P2P function and connect the device to the Internet, we are going to collect device information including but not limited to device IP address, device name, device firmware, device SN. The collected information is only to access the device remotely.

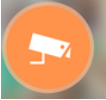



Figure 4-20

Here we use cell phone APP to continue.

Step 1 Use cell phone to scan the QR code and download the APP.

Step 2 After installation, run the APP and Live Preview, enter the main interface. Now you can add device to the APP.

1. Open App; tap  to go to the Live preview.
2. Tap  at the top left corner, you can see the main menu.
3. Tap Device manager button, you can use several modes (P2P/DDNS/IP and etc.) to add the device. Click  to save current setup. Tap Start Live preview to view all-channel video from the connected device. See Figure 4-20.

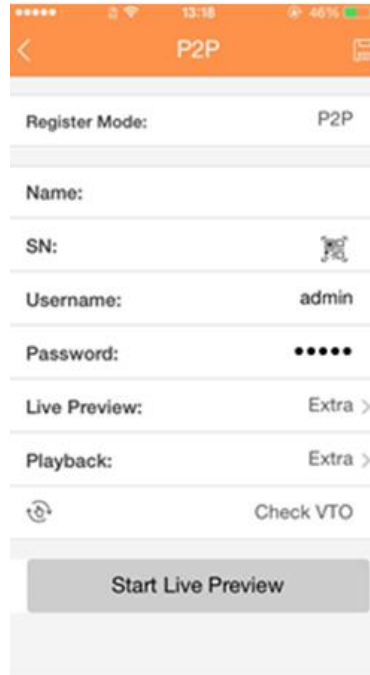

Figure 4-21

4.1.4.4 Registration

 **Note**

You can only see the registration interface if you have set IP channel (Chapter 4.9.1.3.5 Channel type). The DVR supports ONVIF standard protocol.

It is to add/delete the camera to the corresponding channel and view the corresponding information.

Besides startup wizard and configuration wizard, from the main menu->Setting->Camera-> Registration or on the preview window and then right click mouse and then select Camera Registration, you can go to the Registration interface. See Figure 4-22.

Click IP search, and then select device in the searched results, click Add button.

- Uninitialized: Click Uninitialized, device display uninitialized remote device. Select a device from the list and then click Initialize, you can set remote device initial user name and password. Refer to chapter 4.1.4.4.1 Initialize camera for detailed information.
- Show filter: Select from the dropdown list to display the corresponding devices.
 - ✧ None: There is a filter. Device displays all remote devices.
 - ✧ IPC: Device displays network camera.
 - ✧ DVR: Device display storage device such as DVR, NVR and etc.
- IP search: Click it to search IP address. It includes device IP address, port, device name, manufacturer, type. Use your mouse to click the item name, you can refresh display order. Click IP address, system displays IP address from small to large. Click IP address again, you can see icon, system displays IP address from large to small. You can click other items to view information conveniently. For the network device

already added to the device, you can see there is a small icon “*” after the SN in case there is repeatedly add operation.



- Add: Click it to connect to the selected device and add it to the Added device list. Support Batch add.
- Edit: Click button  or double click a device in the list, you can change channel setup.
- Delete: Please select one device in the Added device list and then click  to remove.
- Export: Export the added device list to the USB device. Refer to chapter 4.1.4.4.6 Export for detailed information.
- Import: Click to add several devices at the same time. Refer to chapter 4.1.4.4.7 Import for detailed information.



Figure 4-22

4.1.4.4.1 Initialize Camera

The initialize function in registration interface is to change connected camera login password and IP address.

Steps:

- Step 1 From main menu->Setting->Camera->Registration. Enter Registration interface. See Figure 2-35.
- Step 2 Click IP search and check the Uninitialized box. Device displays uninitialized camera.



Figure 4-23

- Step 3 Select a camera to be initialized and then click Initialize button.
Device displays password setup interface. See Figure 4-24 and Figure 4-25.

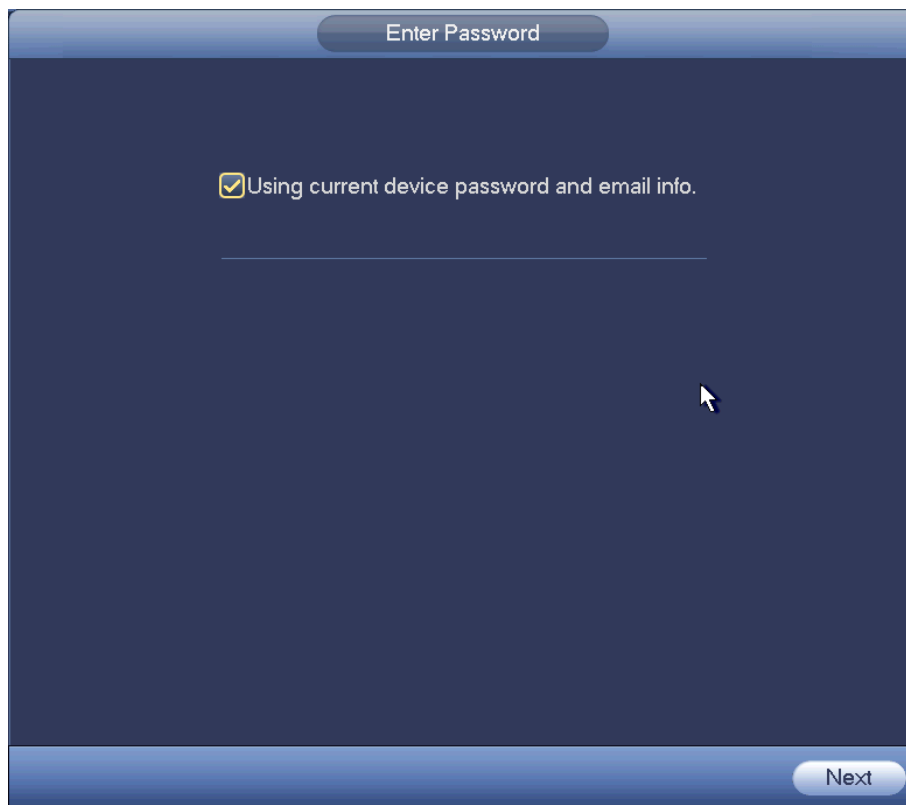

Figure 4-24

Enter Password

Using current device password and email info.

Username admin

Password

It is 8 to 32-digit containing letter(s), number(s), symbol(s). It contains at least two types.

Confirm Password

Next

Figure 4-25

Step 4 Set camera password.

- Using current device password and email: Check the box to use DVR current admin account and email information. There is no need to set password and email. Please go to step 7.
- User name/password: The user name is **admin**. The password ranges from 8 to 32 digitals. It can contain letters, numbers and special characters (excluding “” , “” , “ , ” , “ : ” , “ & ”) . The password shall contain at least two categories. Usually we recommend the strong password.



WARNING

STRONG PASSWORD RECOMMENDED-For your device own safety, please create a strong password of your own choosing. We also recommend you change your password periodically especially in the high security system.

Step 5 Click Next button.

Enter input email interface. See Figure 4-26.

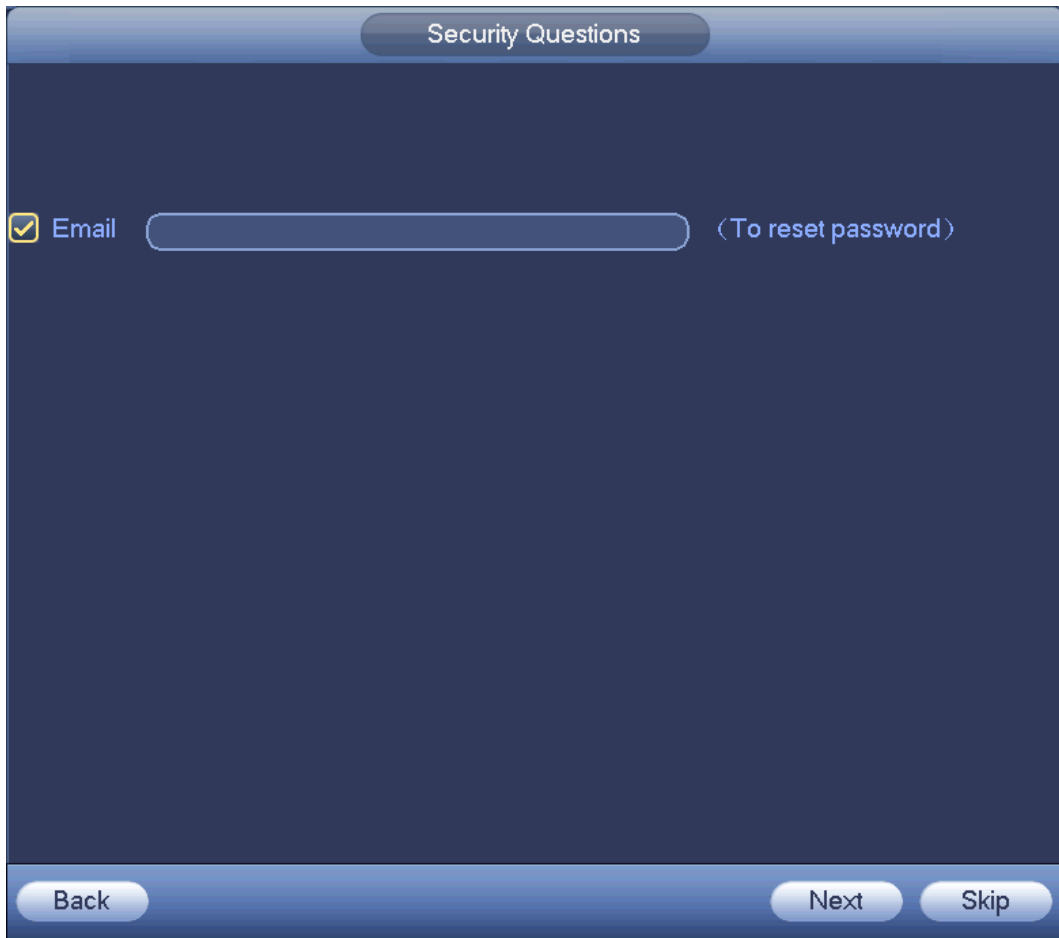

Figure 4-26

Step 6 Set email information.

Email: Input an email address for reset password purpose.

 **Note**

Cancel the box and then click Next or Skip if you do not want to input email information here.

Step 7 Click Next button.

Enter Modify IP address interface. See Figure 4-27.

Modify IP

Checked Device No.: 1

DHCP

STATIC

IP Address Incremental Value

Subnet Mask

Default Gateway

1	Serial No.	IP Address
1	1D004B0YAZ00003	192.168.1.108

Back Next Skip

Figure 4-27

Step 8 Set camera IP address.

- Check DHCP, there is no need to input IP address, subnet mask, and default gateway. Device automatically allocates the IP address to the camera.
- Check Static, and then input IP address, subnet mask, default gateway and incremental value.

 **Note**

- If it is to change several devices IP addresses at the same time, please input incremental value. Device can add the fourth address of the IP address one by one to automatically allocate the IP addresses.
- If there is IP conflict when changing static IP address, device pops up IP conflict dialogue box. If batch change IP address, device automatically skips the conflicted IP and begin the allocation according to the incremental value

Step 9 Click Next button.

Device begins initializing camera. See Figure 4-28.

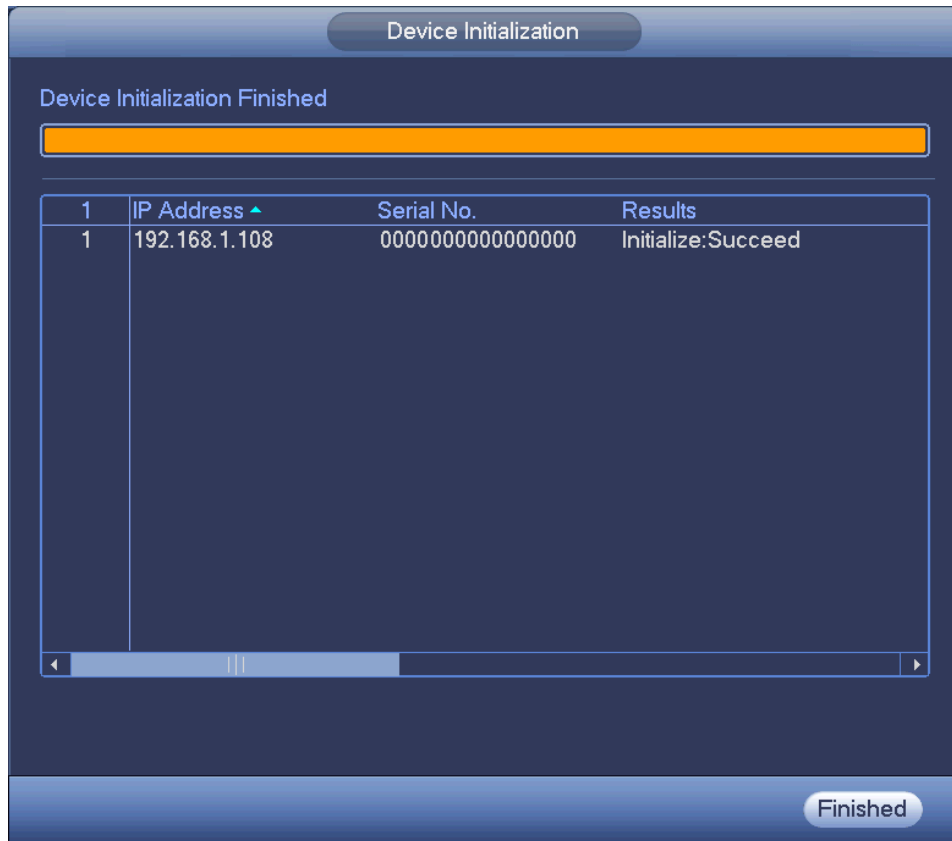

Figure 4-28

Step 10 Click Finish to complete the initialization.

4.1.4.4.2 Auto Add

Step 1 Click IP Search, device displays searched results.

Step 2 Double click an IP address or select an IP address and then click Add button, it is to register the device to the DVR. Device supports batch add.



4.1.4.4.3 Manual Add

Step 1 Click Manual add to register the camera manually. There are three modes: TCP/UDP/Auto. The default setup is TCP. See Figure 4-29.

Step 2 Input the corresponding value and then click OK button.



Note

- This series product supports the IPC from many popular manufactures such as Sony, Hitachi, Axis, Samsung, Dynacolor, Arecont, Onvif and Dahua.
- System default IP address is 192.168.0.0 if you do not input IP address. System will not add current IP address.
- You cannot add two or more devices in the Manual Add interface (Figure 4-29.). Click OK button, system connects to the corresponding front-end device of current channel on the interface.
-  means connection successful.  means connection failed.



The 'Manual Add' dialog box contains the following fields:

Channel	15
Manufacturer	Private
IP Address	192.168.0.0
TCP Port	37777
User Name	admin
Password	•••••
Remote Channel	1
Decoder Buffer	Default

Buttons: OK, Cancel

Figure 4-29

4.1.4.4.4 Modify or Delete Device

- Click  or double click a device in the added list. Device pops up the following dialogue box. See Figure 4-30.



The 'Edit' dialog box contains the following fields:

Channel	15
Manufacturer	Dahua
IP Address	172.8.2.27
TCP Port	37777
User Name	admin
Password	•••••
Remote Channel	1
Decoder Buffer	Default

Buttons: Copy, OK, Cancel

Figure 4-30

- ◇ Select a channel from the dropdown list and change the parameters.

- ◇ Click Copy, device pops up the following dialogue box. It is to copy the user name and password to the selected channel(s). See Figure 4-31.

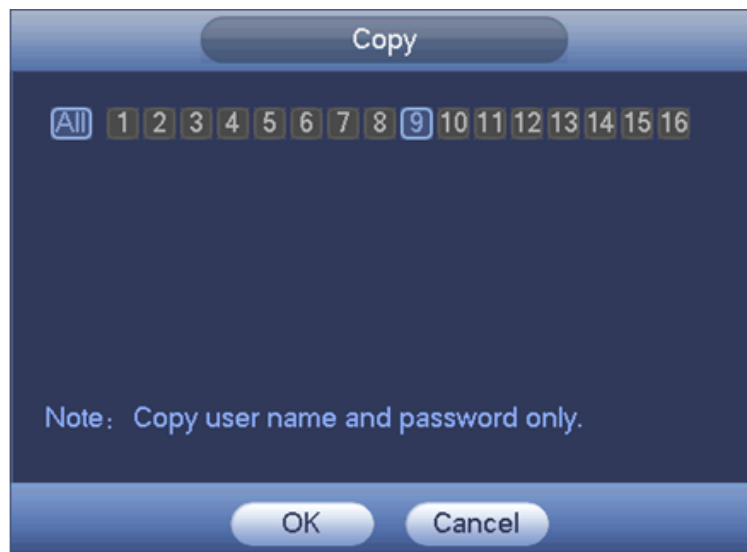



Figure 4-31

- Click  to disconnected the camera and remove it from the added list.
- Select one or several device(s) in the added list, click Delete button to delete. Check the box before the channel number to select all channels at the same time.

4.1.4.4.5 Change IP

It is to change camera IP address. Support change one by one or batch add.

- Change One by One

Click , you can change the information such as IP address, subnet mask, and default gateway, user name, password of the checked device. See Figure 4-32. Click Add button and then click OK, you can add current device to the list,

Modify IP

IP Address: 10 . 15 . 5 . 187

Subnet Mask: 255 . 255 . 0 . 0

Default Gateway: 10 . 15 . 0 . 1

User Name: admin

Password:

Add

OK Cancel

Figure 4-32

- Batch Add

Check several devices at the same time and then click the edit button . See Figure 4-33. Please check Batch modify button and then input start IP, end IP and default gateway.

Modify IP

Batch Modify

Start Address: 10 . 15 . 5 . 190

Subnet Mask: 255 . 255 . 0 . 0

Default Gateway: 10 . 15 . 0 . 1

User Name: admin

Password:

Add

OK Cancel

Figure 4-33

Click Add button and then click OK, it is to add devices to the list,

4.1.4.4.6 IP Export

System can export the Added device list to your local USB device.

Step 1 Insert the USB device and then click the Export button.
Enter the following interface. See Figure 4-34.

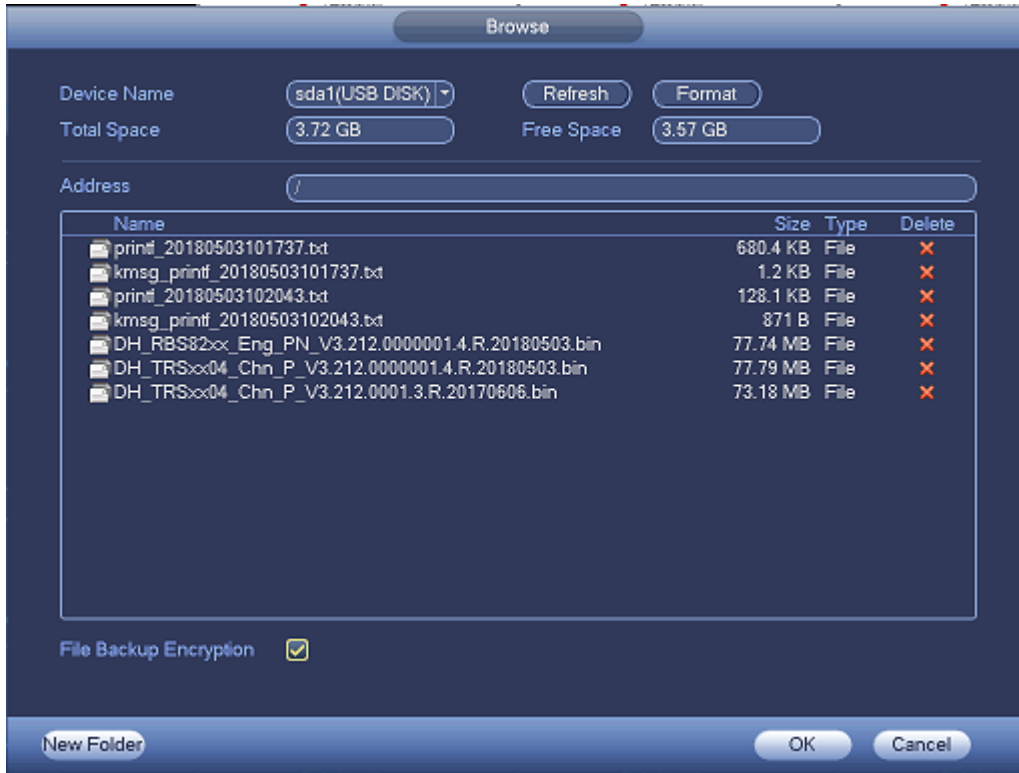

Figure 4-34

Step 2 Select the directory and then click the OK button.
System pops up a dialogue box to remind you successfully exported.

Step 3 Please click OK button to exit.

 **Note**

When export the IP address, system adopts file backup encryption function by default. The file information includes IP address, port, remote channel number, manufacturer, user name and password.

- If you check the box to enable file backup encryption, the exported file extension name is .backup.
- If you cancel the file backup encryption, the exported file extension name is .CSV. There is data leakage risk.

4.1.4.4.7 IP Import

Import IP address to add the camera.

Step 1 Click Import button.
Enter Browse interface. See Figure 4-35.

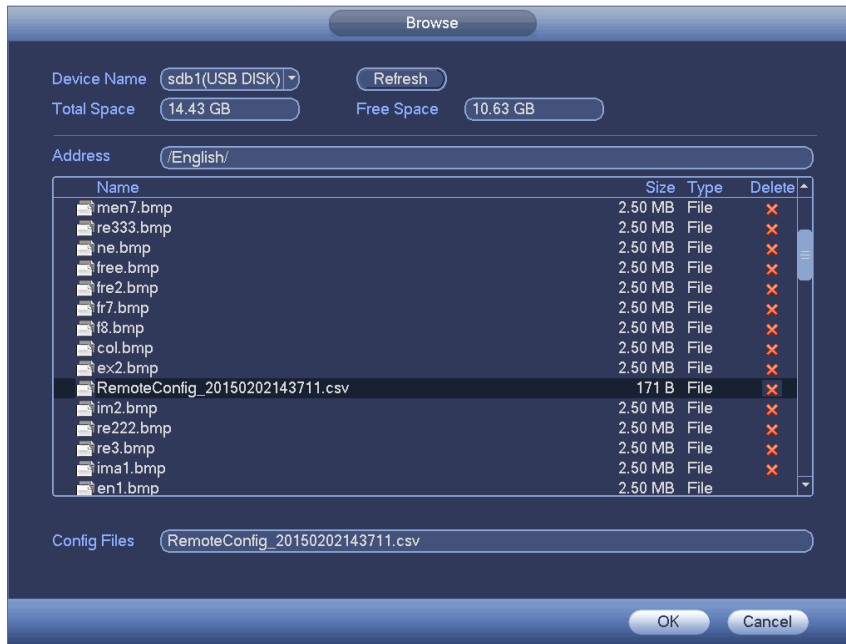

Figure 4-35

- Step 2 Select the import file and then click the OK button.
System pops up a dialogue box to remind you successfully exported.

 **Note**

If the imported IP has conflicted with current added device, system pops up a dialogue box to remind you. You have two options:

- OK: Click OK button, system uses the imported setup to overlay current one.
- Cancel: Click Cancel button, system adds the new IP setup.

- Step 3 Please click OK button to exit.



WARNING

- You can edit the exported .CSV file. **Do not change the file format; otherwise it may result in import failure.**
- Does not support customized protocol import and export.
- The import and export device shall have the same language format.

4.1.4.5 Encode

It is to set video bit streams, image bit streams, and video overlay parameters. Besides startup wizard and configuration wizard, from main menu->Setting->Camera->Encode, you can also go to the following interface.

4.1.4.5.1 Encode

- Step 1 Click Encode tab.
Enter Encode interface. See Figure 4-36.
- Step 2 Set parameters.
- Channel: Select the channel you want.

- Smart codec: Check the box to enable smart codec function. It can lower bit streams, enhance compression rate, and reduce HDD storage space. Please note this function is for main stream only.
- Type: Please select from the dropdown list. There are three options: regular/motion detect/alarm. You can set the various encode parameters for different record types.
- Compression: System supports H.264H, H.264, H.264B, and MJPEG.
 - ✧ H.264H: It is the High Profile compression algorithm. It has the high encode compression rate. It can achieve high quality encode at low bit stream. Usually we recommend this type.
 - ✧ H.264 is the general compression algorithm.
 - ✧ H.264B is the Baseline algorithm. Its compression rate is low. For the same video quality, it has high bit stream requirements.
 - ✧ MJPEG: In this encode mode, the video needs general large bit stream to guarantee the video definition. You can use the max bit stream value in the recommend bit to get the better video output effect.
- Resolution: It is to set video resolution. The higher the resolution is, the better the video quality is.
- Frame rate: It ranges from 1f/s to 25f/s in NTSC mode and 1f/s to 30f/s in PAL mode.
- Bit rate type: System supports two types: CBR and VBR. In VBR mode, you can set video quality.
- Quality: There are six levels ranging from 1 to 6. The sixth level has the highest image quality.
- Video/audio: You can enable or disable the video/audio.
- Audio format: Please select from the dropdown list. There are three options: G711a/G711u/PCM.
- Audio source: Please select from the dropdown list. There are two options: local/HDCVI. For local mode, the audio signal is from the Audio In port. For HDCVI mode, the audio signal is from the coaxial cable of the camera.

Step 3 Click Save button.



Figure 4-36

4.1.4.5.2 Snapshot

It is set snapshot mode for each channel, and picture size, quality and frequency.

Step 1 Click Snapshot tab, enter the following interface. See Figure 4-37.

Step 2 Set parameters.

- Manual snap: The manual snapshot amount. The value ranges from 1 to 5.
- Snapshot mode: There are two modes: timing and trigger. If you set timing mode, you need to set snapshot frequency. If you set trigger snapshot, you need to set snapshot activation operation.
- Image size: Here you can set snapshot picture size.
- Image quality: Here you can set snapshot quality. The value ranges from 1 to 6.
- Interval: It is for you to set timing (schedule) snapshot interval.



Figure 4-37

Step 3 Click Apply or Save to complete setup.

4.1.4.5.3 Overlay

It is to set preview or monitor cover-area, and time/channel title position.

Step 1 Click Overlay tab, interface is shown as in Figure 4-38.

Step 2 Set parameters.

- Cover area: Here is for you to set cover area. You can drag you mouse to set proper section size. In one channel video, system max supports 4 zones in one channel.
- Preview/monitor: privacy mask has two types. Preview and Monitor. Preview means the privacy mask zone cannot be viewed by user when system is in preview status. Monitor means the privacy mask zone cannot be view by the user when system is in monitor status.
- Time display: You can select system displays time or not when you playback. Please click set button and then drag the title to the corresponding position in the screen.
- Channel display: You can select system displays channel number or not when you playback. Please click set button and then drag the title to the corresponding position in the screen.
- Copy:After you complete the setup, you can click Copy button to copy current setup to other channel(s). You can see an interface is shown as in Figure 4-39. You can see current channel number is grey. Please check the number to select the channel or you

can check the box ALL. Please click the OK button in Figure 4-39 and Figure 4-38 respectively to complete the setup.



Figure 4-38

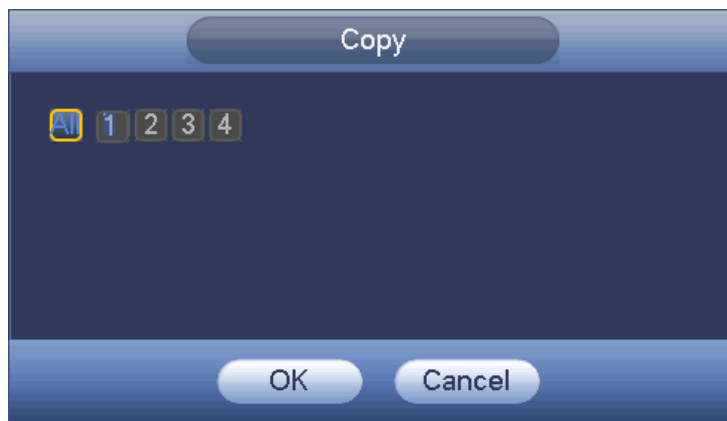

Figure 4-39

Step 3 Click Apply or Save to complete setup.

4.1.4.6 Basic

It is to manage HDD storage space.

Besides startup wizard and configuration wizard, from main menu->Setting->Storage->Basic, you can also go to the following interface.

Step 1 From main menu->Setting->Storage->Basic.

Enter Basic interface, See Figure 4-40.

Step 2 Set parameters.

- HDD full: It is to select working mode when hard disk is full. There are two options: stop recording or overwrite.
- ◇ Stop: If current HDD is full while there is no idle HDD, then system stops recording,
- ◇ Overwrite: If the current HDD is full while there is no idle HDD, then system overwrites the previous files.

 **Note**

DVR does not overwrite the locked files.

- Pack duration: Here is for you to specify record duration. There are two ways for you to set.
 - ◇ Time length: It is to pack according to time. The value ranges from 1 to 60 minutes. Default value is 60 minutes.
 - ◇ File length: It is to pack according to file length. The default setup is 1024M. The value ranges from 128M to 2048M.
- Auto delete old files:
 - ◇ Never: Do not auto delete old files.
 - ◇ Customized: input customized period here, system can auto delete corresponding old files.



Figure 4-40

4.1.4.7 Schedule

Besides startup wizard and configuration wizard, from main menu->Setting->Storage->Schedule, you can also go to the following interface.

 **Note**



- You need to have proper rights to implement the following operations. Please make sure the HDDs have been properly installed.
- After the system booted up, it is in default 24-hour regular mode. You can set record type and time in schedule interface.
- Please note you need to go to main menu->Setting->System->General->Holiday to set holiday date first, otherwise, there is no holiday setup item.

4.1.4.7.1 Record

Step 1 Click Next button, enter Schedule interface. See Figure 4-44.

Step 2 Set parameters.

- Channel: Please select the channel number first. You can select “all” if you want to set for the whole channels.

✧ : Sync connection icon. Select icon  of several dates, all checked items can be edited together. Now the icon is shown as .

✧ : Click it to delete a record type from one period.

- Record Type: Please check the box to select corresponding record type. There are five types: Regular/MD (motion detect)/Alarm/MD&Alarm/intelligent.
- Week day: There are eight options: ranges from Saturday to Sunday and all.
- Holiday: It is to set holiday setup. Please note you need to go to the General interface (Main Menu->Setting->System->General) to add holiday first. Otherwise you cannot see this item.
- Pre-record: System can pre-record the video before the event occurs into the file. The value ranges from 1 to 30 seconds depending on the bit stream.
- Redundancy: System supports redundancy backup function. You can highlight Redundancy button to activate this function. Please note, before enable this function, please set at least one HDD as redundant. (Main menu->Setting->Storage->HDD Manager). **Please note this function is null if there is only one HDD.**
- Period setup: Click button  after one date or a holiday, you can see an interface shown as in Figure 4-45. There are five record types: regular, motion detection (MD), Alarm, MD & alarm and intelligent.

Please following the steps listed below to draw the period manually.

✧ Select a channel you want to set. See Figure 4-41.



Figure 4-41

✧ Set record type. See Figure 4-42.



Figure 4-42

- ✧ Please draw manually to set record period. There are six periods in one day. See Figure 4-43.

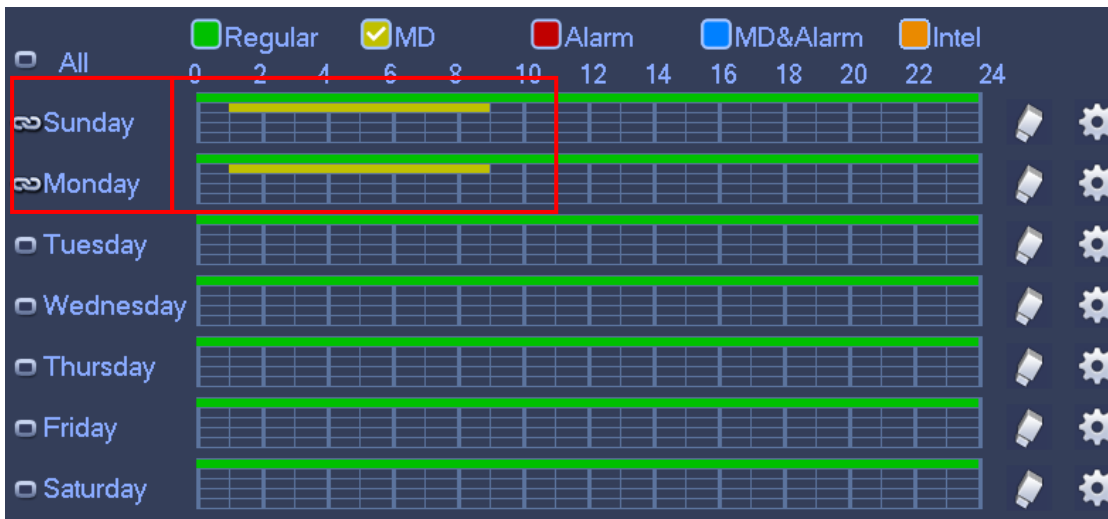

Figure 4-43

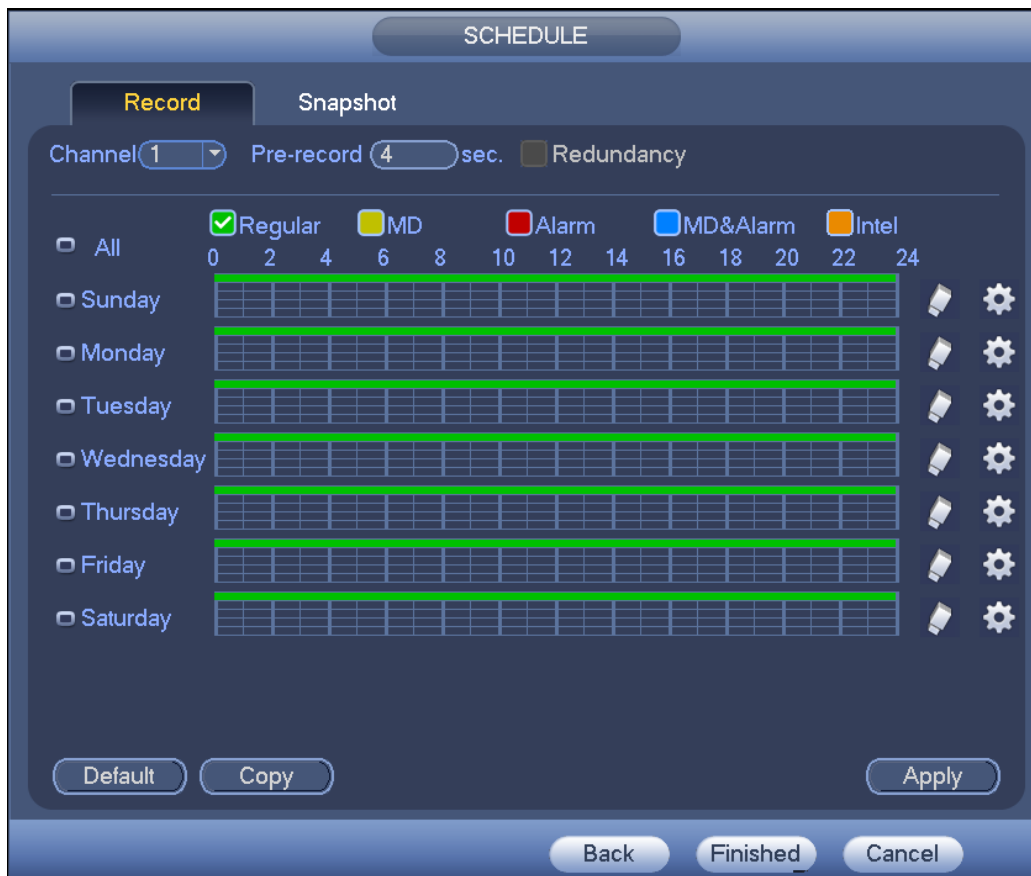

Figure 4-44

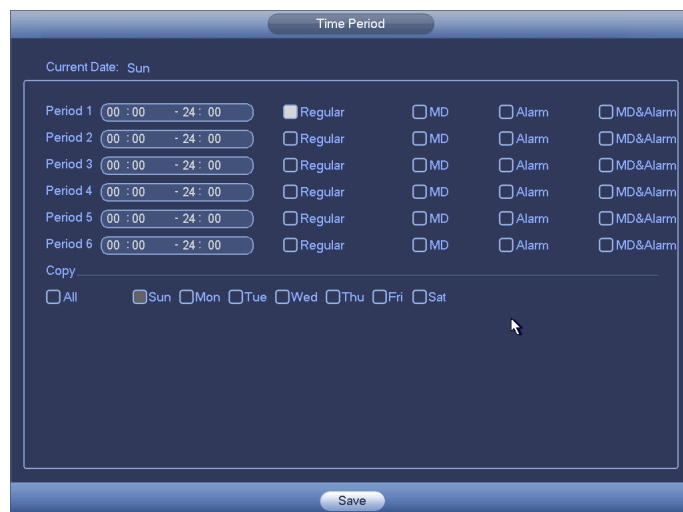

Figure 4-45

Step 3 Click Apply to exit.

Note

After setting in the Schedule interface, please refer to the following contents to enable schedule record function.

- From main menu->Setting->Event, select corresponding event and then enable record function. Refer to chapter 4.9.3 Alarm events for detailed information.
- From main menu->Setting->Storage->Record, set record mode as auto. Refer to chapter 4.9.4.6 Record for detailed information.

4.1.4.7.2 Snapshot

Device snapshots images as you set here.

Refer to chapter 4.1.4.7.1 Record for detailed information.

Note

After setting in the Schedule interface, please refer to the following contents to enable schedule snapshot function.

- From main menu->Setting->Event, select corresponding event and then enable record function. Refer to chapter 4.9.3 Alarm events for detailed information.
- From main menu->Setting->Storage->Record, set record mode as auto. Refer to chapter 4.9.4.6 Record for detailed information.

Quick Setup

Copy function allows you to copy one channel setup to another. After setting in channel 1, click Copy button, you can go to interface Figure 4-46. You can see current channel name is grey such as channel 1. Now you can select the channel you want to paste such as channel 5/6/7. If you want to save current setup of channel 1 to all channels, you can click the first box "ALL". Click the OK button to save current copy setup. Click the OK button in the Encode interface, the copy function succeeded.



Figure 4-46

Redundancy

Redundancy function allows you to memorize record file in several disks. When there is file damage occurred in one disk, there is a spare one in the other disk. You can use this function to maintain data reliability and safety.

- In the main menu, from Setting->Storage-> Schedule, you can highlight redundancy button to enable this function.
- In the main menu, from Main menu->Setting->Storage->HDD Manager, you can set one or more disk(s) as redundant. You can select from the dropdown list. System auto overwrites old files once hard disk is full.

Please note only read/write disk or read-only disk can backup file and support file search function, so you need to set at least one read-write disk otherwise you cannot record video.



Note

About redundancy setup:

- If current channel is not recording, current setup gets activated when the channel begin recording the next time.
- If current channel is recording now, current setup will get activated right away, the current file will be packet and form a file, then system begins recording as you have just set.

After you completed all the setups, please click Save button.

Playback or search in the redundant disk.

There are two ways for you to playback or search in the redundant disk.

- Set redundant disk(s) as read-only disk or read-write disk (Main menu->Setting->Storage->HDD Manager)). System needs to reboot to get setup activated. Now you can search or playback file in redundant disk.
- Dismantle the disk and play it in another PC.

4.2 Preview

4.2.1 Preview Window

After you logged in, the system is in live viewing mode. See Figure 4-47. It is to display

system date, time, channel name and window number. If you want to change system date and time, please refer to general settings (Main Menu->Setting->System->General). If you want to modify the channel name, please refer to the display settings (Main Menu->Camera->CAM name)

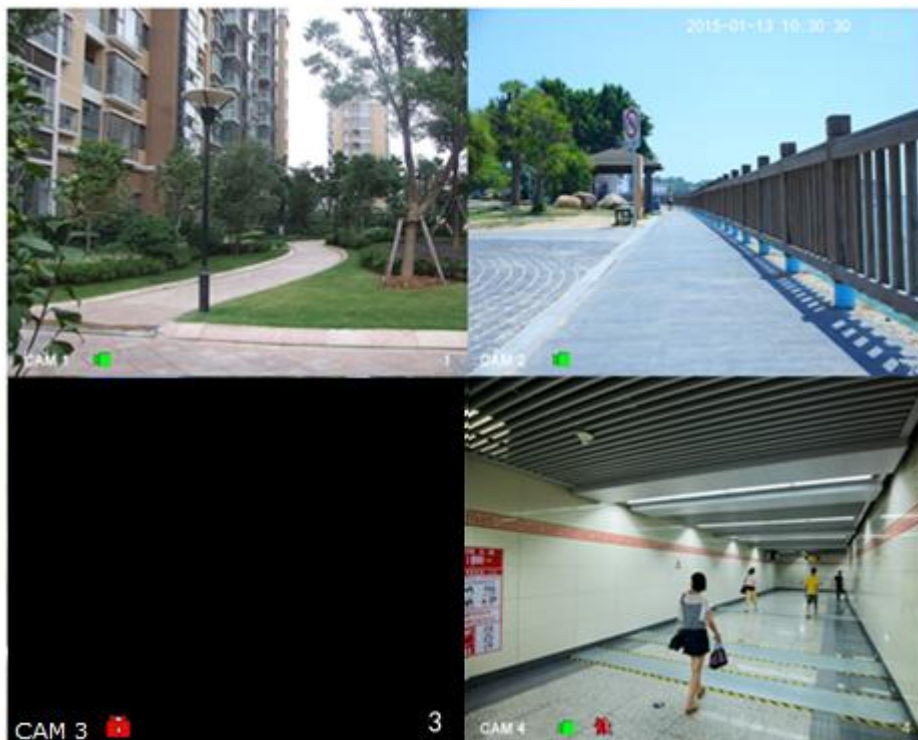





Figure 4-47

SN	Icon	Function
1		When current channel is recording, system displays this icon.
2		When motion detection alarm occurs, system displays this icon.
3		When video loss alarm occurs, system displays this icon.
4		When current channel is in monitor lock status, system displays this icon.

Tips

Preview drag: If you want to change position of channel 1 and channel 2 when you are previewing, you can left click mouse in the channel 1 and then drag to channel 2, release mouse you can switch channel 1 and channel 2 positions.

4.2.2 Preview Control

The preview control function has the following features.

- Support preview playback.

- ✧ In the preview desktop, system can playback previous 5-60 minutes record of current channel. Please go to the Main Menu->General to set real-time playback time.
- ✧ Support drag and play function. You can use your mouse to select any playback start time.
- ✧ Support playback, pause and exit function.
- ✧ Right now, system does not support slow playback and backward playback function.
- Support digital zoom function.
- Support real-time backup function.

You can follow the contents listed below for the operation instruction.

Preview control interface

Move your mouse to the top center of the video of current channel, you can see system pops up the preview control interface. See Figure 4-48 and Figure 4-49.

Note

If your mouse stays in this area for more than 6 seconds and has no operation, the control bar automatically hides.



Figure 4-48 Analog Channel



Figure 4-49 Digital Channel

1) Instant playback

It is to playback the previous 5-60 minutes record of current channel.

Please go to the Main menu->Setting->->System->General to set instant playback time. See Figure 4-50.

System may pop up a dialogue box if there is no such record in current channel.

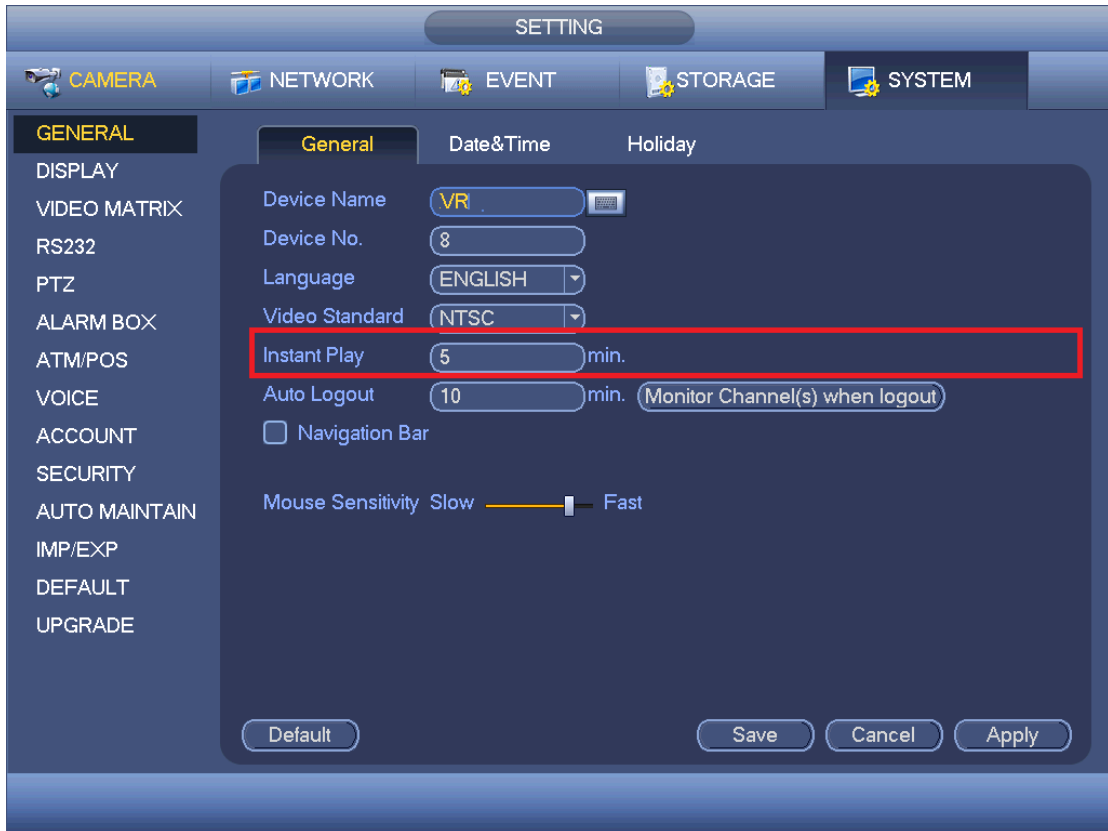



Figure 4-50

2) Digital zoom

It is to zoom in specified zone of current channel. It supports zoom in function of multiple-channel.

Click button , the button is shown as .

There are two ways for you to zoom in.

- Drag the mouse to select a zone, you can view an interface show as Figure 4-51.



Figure 4-51

- Put the middle button at the center of the zone you want to zoom in, and move the mouse, you can view an interface shown as in Figure 4-52.



Figure 4-52

Right click mouse to cancel zoom and go back to the original interface.

3) Manual record function

It is to backup the video of current channel to the USB device. System cannot backup the video of multiple-channel at the same time.

Click button , system begins recording. Click it again, system stops recording. You can find the record file on the flash disk.



4) Manual Snapshot



Click  to snapshot 1-5 times. The snapshot file is saved on the USB device or HDD. You can go to the Search interface (chapter 4.7.1) to view.

5) Mute (For analog channel only)

Click to mute. Click again to enable audio function when preview. Please note this function is for one-window mode only.

6) Bidirectional talk (For channel connected via private protocol only)

If the connected front-end device supports bidirectional talk function, you can click this button. Click button  to start bidirectional talk function the icon now is shown as . Now the rest bidirectional talk buttons of digital channel becomes null too.

Click  again, you can cancel bidirectional talk and the bidirectional talk buttons of other digital channels become as .

7) Remote device (For digital channel only)

Shortcut menu. Click it to go to the remote device interface to add/delete remote device or view its corresponding information. Please refer to chapter 4.9.1.1 for detailed information.

4.3 Right-Click Menu

On the preview interface, right click mouse, you can view menu interface shown as in Figure 4-53.



Note

- After you go to the corresponding interface, right click mouse to go back to the

upper-level.

- The following figure for reference only. Slight difference may be found on the user interface.
- Window split mode: You can select window amount and then select channels.
- Previous screen/next screen: Click it to go to the previous screen/next screen.
- PTZ: Click it to go to PTZ interface.
- Auto focus: Please make sure you connected network camera supports this function.
- Color setting: Set video corresponding information.
- Display: Set video output rate.
- Face search: It is to display human face list and view human face record.
- Search: Click it to go to Search interface to search and playback a record file.
- Record control: Enable/disable record channel.
- Alarm output: Enable/disable alarm output function.
- Remote device: Click it to add remote device.
- Video matrix: Set video matrix tour channel and interval.
- Main menu: Go to system main menu interface.

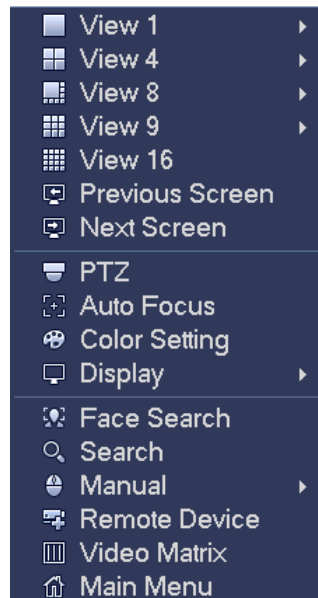

Figure 4-53

4.3.1 Window Switch

System supports 1/4/8/9-window (The options here depend on your product channel amount). You can select from the dropdown list. See Figure 4-54.

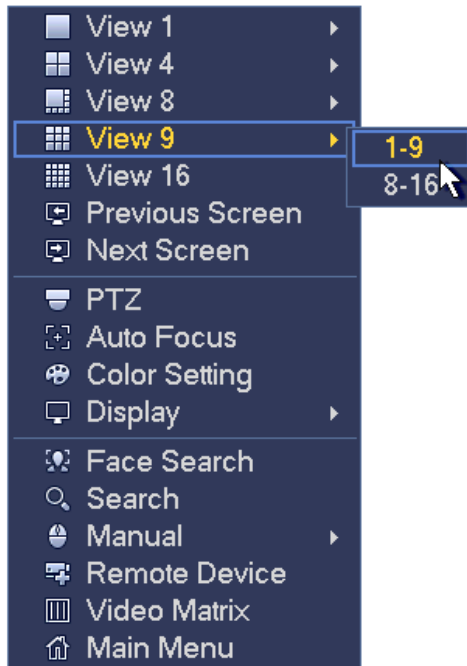

Figure 4-54

4.3.2 Previous Screen/Next Screen

Click it to go to the previous screen/next screen. For example, if you are using 4-split mode, the first screen is displaying the channel 1-4, click Next screen, you can view channel 5-8.

4.3.3 PTZ Control



The PTZ setup is shown as in See Figure 4-55.

Please note the commend name is grey once device does not support this function.

The PTZ operation is only valid in one-window mode.

Here you can control PTZ direction, speed, zoom, focus, iris, preset, tour, scan, pattern aux function, light and wiper, rotation and etc.

Speed is to control PTZ movement speed. The value ranges from 1 to 8. The speed 8 is faster than speed 1. You can use the remote control to click the small keyboard to set.

You can click  and  of the zoom, focus and iris to zoom in/out, definition and brightness.

The PTZ rotation supports 8 directions. If you are using direction buttons on the front panel, there are only four directions: up/down/left/right.



Figure 4-55

In the middle of the eight direction arrows, there is a 3D intelligent positioning key. See Figure 4-56. Please make sure your protocol supports this function and you need to use mouse to control.

Click this key, system goes back to the single screen mode. Drag the mouse in the screen to adjust section size. The dragged zone supports 4X to 16X speeds. It can realize PTZ automatically. The smaller zone you dragged, the higher the speed.



Figure 4-56

Name	Function key	function	Shortcut key	Function key	function	Shortcut key
Zoom		Near			Far	
Focus		Near			Far	
Iris		close			Open	

In Figure 4-55, click to open the menu, you can set preset, tour, pattern, scan and etc. See Figure 4-57.













Figure 4-57

Please refer to the following sheet for detailed information.

Please note the above interface may vary due to different protocols. The button is grey and cannot be selected once the current function is null.

Right click mouse or click the ESC button at the front panel to go back to the Figure 4-55.

Icon	Function	Icon	Function
	Preset		Flip
	Tour		Reset
	Pattern		Aux
	Scan		Aux on-off button
	Rotate		Go to menu

4.3.3.1 PTZ Function Setup



Click , you can go to the following interface to set preset, tour, pattern, and scan. See Figure 4-58.



Figure 4-58

Preset Setup

In Figure 4-58, click preset button and use eight direction arrows to adjust camera to the proper position. The interface is shown as in Figure 4-59.

Click Set button and then input preset number.

Click Set button to save current preset.



Figure 4-59

Tour Setup

In Figure 4-58, click tour button.

Input tour value and preset No. Click Add preset button to add current preset to the tour. See Figure 4-60.

Tips

Repeat the above steps to add more presets to the tour. Click Del preset button to remove it from the tour. Please note some protocols do not support delete preset function.



Figure 4-60

Pattern Setup

In Figure 4-58, click Pattern button and input pattern number.

Click Begin button to start direction operation. Or you can go back to Figure 4-55 to operate zoom/focus/iris/direction operation.

In Figure 4-58, click End button.



Figure 4-61

Scan Setup

In Figure 4-58, click Scan button.

Use direction buttons to set camera left limit and then click Left button.



Use direction buttons to set camera right limit and then click Right button. Now the scan setup process is complete.





Figure 4-62

4.3.3.2 Call PTZ Function



Call Preset

In Figure 4-57, input preset value and then click  to call a preset. Click  again to stop call.



Call Pattern

In Figure 4-57, input pattern value and then click  to call a pattern. Click  again to stop call.

Call Tour

In Figure 4-57, input tour value and then click  to call a tour. Click again  to stop call.

Call Scan

In Figure 4-57, input Scan value and then click  to call a tour. Click again  to stop call.

Rotate

In Figure 4-57, click  to enable the camera to rotate. System supports preset, tour, pattern, scan, rotate, light and etc function.



Note

- Preset, tour and pattern all need the value to be the control parameters. You can define it as you require.
- You need to refer to your camera user's manual for Aux definition. In some cases, it can be used for special process.

Aux



Click , system goes to the following interface. The options here are defined by the protocol. The aux number is corresponding to the aux on-off button of the decoder. See Figure 4-63.

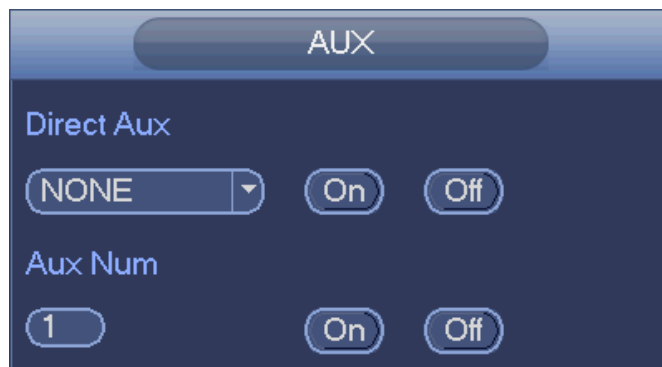

Figure 4-63

4.3.4 Auto Focus



Note

- This function is for the motorized-lens network camera.
- For HD auto focus camera, you can go to the PTZ control interface to set. Please refer to Chapter 4.3.3 PTZ.

On the preview interface, right click mouse and then select Auto focus, you can go to the following interface. See Figure 4-64.

It is to set auto focus and zoom function. Click auto focus function, camera can realize auto focus function.

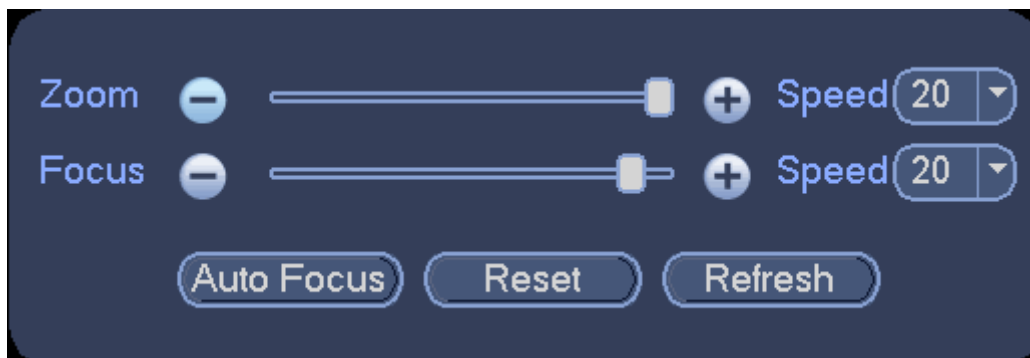

Figure 4-64

4.3.5 Color

Here you can set hue, brightness, contrast, saturation, gain, white level, color mode and etc. See Figure 4-65.

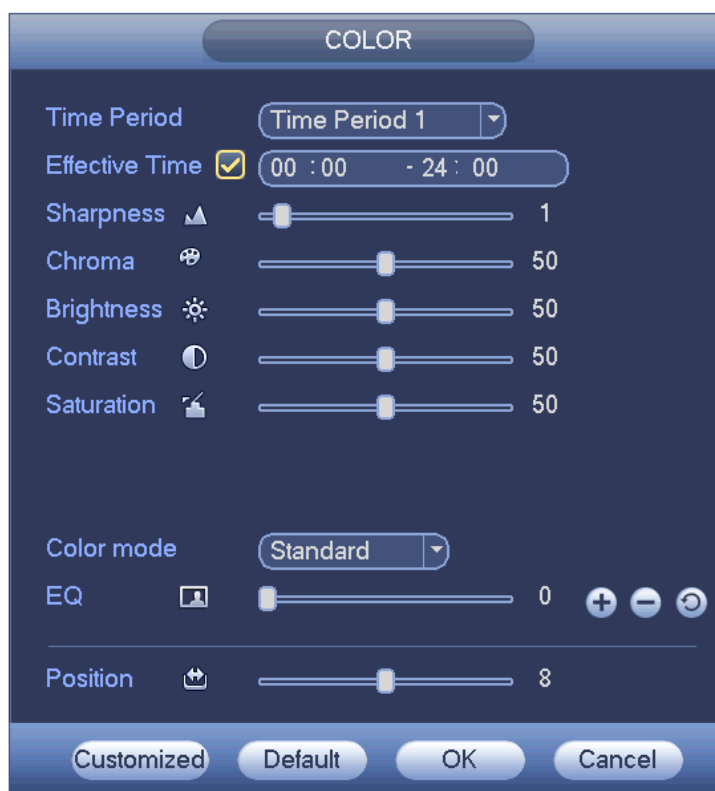







Figure 4-65

Please refer to the following sheet for detailed information.

Item	Note
Period	There are two periods in one day. You can set different sharpness, brightness, and contrast setup for different periods.

Item	Note
Effective Time	Check the box here to enable this function and then set period time.
Sharpness	The value here is to adjust the edge of the video. The value ranges from 0 to 100. The larger the value is, the clear the edge is and vice versa. Please note there is noise if the value here is too high. The default value is 50 and the recommended value ranges from 40 to 60.
Brightness	It is to adjust monitor window bright. The value ranges from 0 to 100. The default value is 50. The larger the number, the bright the video is. When you input the value here, the bright section and the dark section of the video will be adjusted accordingly. You can use this function when the whole video is too dark or too bright. Please note the video may become hazy if the value is too high. The recommended value ranges from 40 to 60.
Contrast	It is to adjust monitor window contrast. The value ranges from 0 to 100. The default value is 50. The larger the number, the higher the contrast is. You can use this function when the whole video bright is OK but the contrast is not proper. Please note the video may become hazy if the value is too low. If this value is too high, the dark section may lack brightness while the bright section may over exposure .The recommended value ranges from 40 to 60.
Saturation	It is to adjust monitor window saturation. The value ranges from 0 to 100. The default value is 50. The larger the number, the strong the color is. This value has no effect on the general brightness of the whole video. The video color may become too strong if the value is too high. For the grey part of the video, the distortion may occur if the white balance is not accurate. Please note the video may not be attractive if the value is too low. The recommended value ranges from 40 to 60.
Gain	The gain adjust is to set the gain value. The default value may vary due to different device models. The smaller the value, the low the noise. But the brightness is also too low in the dark environments. It can enhance the video brightness if the value is high. But the video noise may become too clear.
White level	It is to enhance image effect.

Item	Note
Color mode	It includes several modes such as standard, color, bright, gentle. Select a color mode, the sharpness, brightness, contrast and etc can automatically switch to corresponding setup.
EQ	<p>Click  or  to adjust image equalization value.</p> <p>Click reset button , system can auto adjust the video to the best effect.</p> <p> Note</p> <p>This function is for HD analog channel only.</p>
Image position	<p>It is to adjust the image position on the screen. The value here refers to the pixel. The default pixel value is 16.</p> <p> Note</p> <p>This function is for analog channel only.</p>

4.3.6 Display

It is to set display output mode. There are two modes: full screen/image original rate. Icon

 means current display output mode. See Figure 4-66.

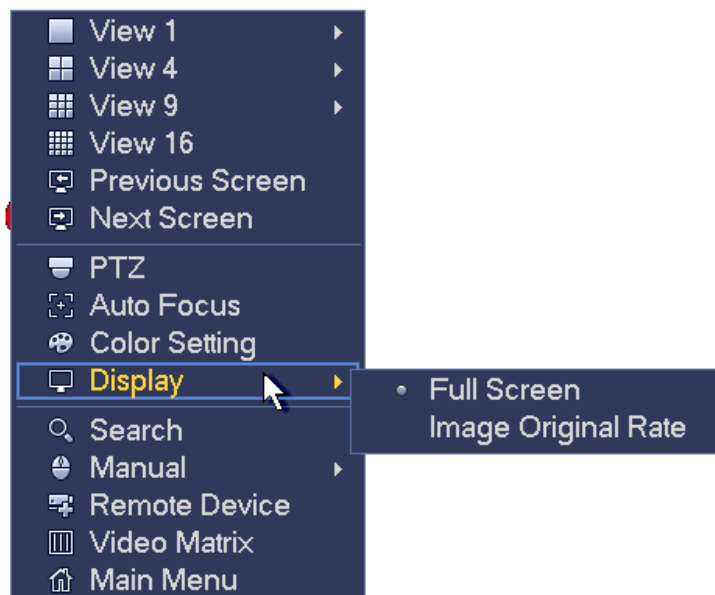

Figure 4-66

4.3.7 Face Search

It is to display human face record list, and view human face recognition record file.

4.3.8 Search

Please refer to chapter 4.7.1 for detailed information.

4.3.9 Record Control

Please refer to chapter 4.9.4.6 for detailed information.

4.3.10 Alarm Output

Please refer to chapter 4.9.3.10 for detailed information.

4.3.11 Remote Device

Please refer to chapter 4.9.1.1 for detailed information.

4.3.12 Video Matrix

Please refer to chapter 4.9.5.3 for detailed information.

4.3.13 Main menu

Please refer to chapter 4.6 for detailed information.

4.4 Navigation Bar

You need to go to the Main menu->Setting->System->General to enable navigation bar function; otherwise you cannot see the following interface.

The navigation bar is shown as below. See Figure 4-67.



Figure 4-67



4.4.1 Main Menu

Click button  to go to the main menu interface.

4.4.2 Output Screen



Select corresponding window-split mode and output channels.

4.4.3 Previous/Next Screen

Click  to go to the previous screen, click  to go to the next screen. For example, if you are using 4-split mode, the first screen is displaying the channel 1-4,

click , you can view channel 5-8.

4.4.4 Tour

Click button  to enable tour, the icon becomes , you can see the tour is in process.

4.4.5 Favorites

Click , system pops up add/edit favorites. See Figure 4-68.



Figure 4-68

4.4.6 Channel

It is to pop up channel tree. You can left click to select a channel on the tree and then drag it to the preview window on the left pane.

4.4.7 PTZ

Click , system goes to the PTZ control interface. Please refer to chapter 4.3.3.

4.4.8 Color

Click button , system goes to the color interface. Please refer to chapter 4.3.5.

4.4.9 Search

Click button , system goes to search interface. Please refer to chapter 4.7.1

4.4.10 Alarm Status

Click button , system goes to alarm status interface. It is to view device status and channel status. Please refer to chapter 4.9.3.

4.4.11 Channel Info

Click button , system goes to the channel information setup interface. It is to view information of the corresponding channel. See Figure 4-69.

CHANNEL INFO									
Channel	Motion	Video Loss	Tampering	Record	Status	Record Mode	Resolution	Frame Rate	Bit Rate
1	●	▲	●	●	●	Pre-record	1280*720	25	
2	●	▲	●	●	●	Pre-record	1280*720	25	
3	●	▲	●	●	●	Pre-record	1280*720	25	
4	●	▲	●	●	●	Pre-record	1280*720	25	
5	●	▲	●	●	●	Pre-record	1280*720	25	
6	●	▲	●	●	●	Pre-record	1280*720	25	
7	●	▲	●	●	●	Pre-record	1280*720	25	
8	●	▲	●	●	●	Pre-record	1280*720	25	
9	●	▲	●	●	●	Pre-record	1280*720	25	
10	●	▲	●	●	●	Pre-record	1280*720	25	
11	●	▲	●	●	●	Pre-record	1280*720	25	
12	●	▲	●	●	●	Pre-record	1280*720	25	
13	●	▲	●	●	●	Pre-record	1280*720	25	
14	●	▲	●	●	●	Pre-record	1280*720	25	
15	---	---	---	---	●				
16	●	●	●	●	●	Pre-record	960*480	25	

Refresh

Figure 4-69

4.4.12 Registration

Click , system goes to an interface for you to view remote device information. Please refer to chapter 4.9.1.1.

4.4.13 Network

Click , system goes to the network interface. It is to set network IP address, default gateway and etc. Please refer to chapter 4.9.2.

4.4.14 HDD Manager

Click , system goes to the HDD manager interface. It is to view and manage HDD information. Please refer to chapter 4.9.4.3.

4.4.15 USB Manager

Click , system goes to the USB Manager interface. It is to view USB information, backup and update. Please refer to chapter 4.7.3 Backup, chapter 4.8.4 Log, Chapter 4.9.5.12 Import/Export,, and chapter 4.9.5.14 Upgrade for detailed information.

4.5 USB Device Auto Pop-up

After you inserted the USB device, system can auto detect it and pop up the following dialogue box. It allows you to conveniently backup file, log, configuration or update

system. See Figure 4-70. Please refer to chapter 4.7.3 Backup, chapter 4.8.4 Log, Chapter 4.9.5.12 Import/Export,, and chapter 4.9.5.14 Upgrade for detailed information.



Figure 4-70

4.6 Main Menu

The main menu interface is shown as below. See Figure 4-71.

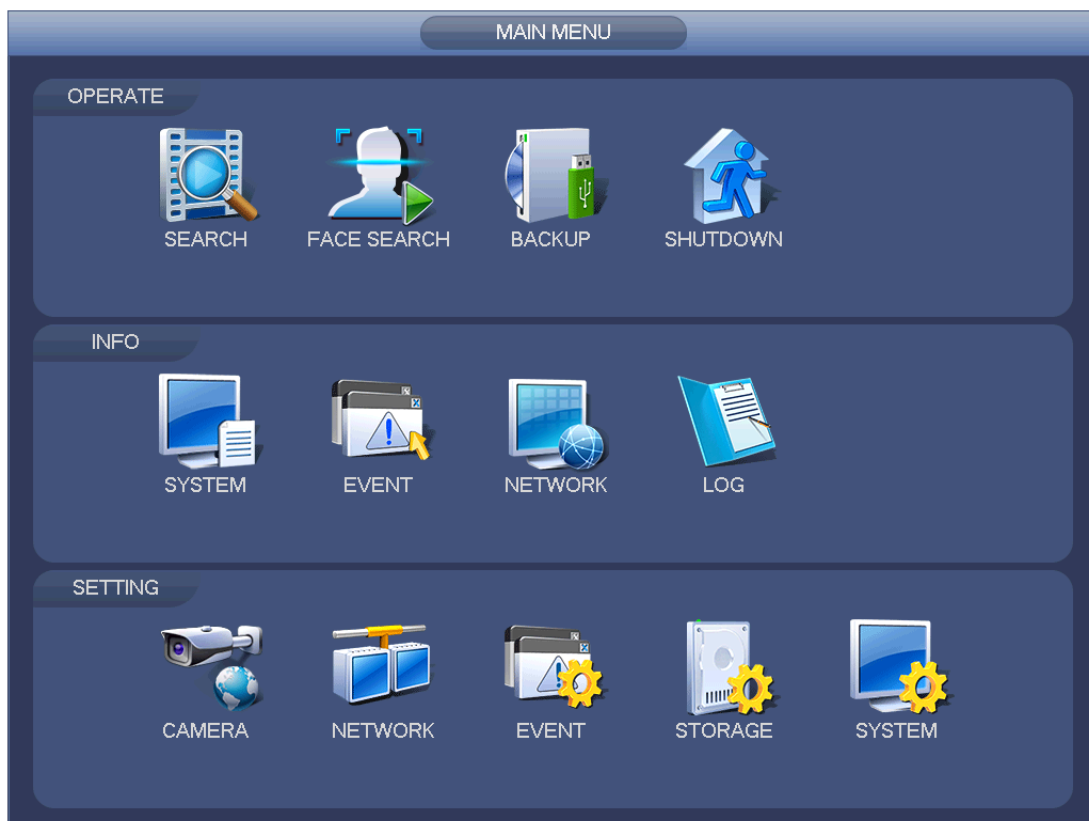

Figure 4-71

4.7 Operation

4.7.1 Search

Click search button in the main menu, search interface is shown as below. See Figure 4-72.

Usually there are four file types:

- R: Regular recording file.
- A: External alarm recording file.
- M: Motion detection recording file
- Orange: Intelligent recording file.

















Figure 4-72

Please refer to the following sheet for more information.

SN	Name	Function
1	Display window	<ul style="list-style-type: none"> ● Here is to display the searched picture or file. ● Support 1/4/9/16-window playback.

2	Search type	<ul style="list-style-type: none"> ● Here you can select to search the picture or the recorded file. ● You can select to play from the read-write HDD, from peripheral device or from redundancy HDD. ● Before you select to play from the peripheral device, please connect the corresponding peripheral device. You can view all record files of the root directory of the peripheral device. Click the Browse button; you can select the file you want to play. ● Check the box here; you can enable splice playback function. Please refer to chapter 4.7.1.4 for detailed information. <p>Important</p> <ul style="list-style-type: none"> ● Redundancy HDD does not support picture backup function, but it supports picture playback function. You can select to play from redundancy HDD if there are pictures on the redundancy HDD.
3	Calendar	<ul style="list-style-type: none"> ● The blue highlighted date means there is picture or file. Otherwise, there is no picture or file. ● In any play mode, click the date you want to see, you can see the corresponding record file trace in the time bar.
4	Playback mode and channel selection pane.	<ul style="list-style-type: none"> ● Playback mode:1/4/9/16/customized. (It may vary due to different series.) ◇ In 1-window playback mode: you can select 1-16 channels. ◇ In 4-window playback mode: you can select 4 channels according to your requirement. ◇ In 9-window playback mode, you can switch between 1-8 and 9-16 channels. ◇ In 16-window playback mode, you can switch between 1-16 and 17-32 channels. ◇ In customized mode, you can select one or more channel(s) you want to playback at the same time. See chapter 4.7.1.4. ● The time bar will change once you modify the playback mode or the channel option.
5	Card number search	<p>The card number search interface is shown as below. Here you can view card number/field setup bar. You can implement advanced search.</p> 
6	Mark file list button	<p>Click it to go to mark file list interface. You can view all mark information of current channel by time. Please refer to chapter 4.7.1.3 for detailed information. Please note only the product of this icon supports mark function.</p>

7	File list switch button	<ul style="list-style-type: none"> ● Double click it, you can view the picture/record file list of current day. ● The file list is to display the first channel of the record file. ● The system can display max 128 files in one time. Use the ◀ and ▶ or the mouse to view the file. Select one item, and then double click the mouse or click the ENTER button to playback. ● You can input the period in the following interface to begin accurate search. ● File type:R—regular record; A—external alarm record; M—Motion detect record.  <ul style="list-style-type: none"> ● Lock file. Click the file you want to lock and click the button  to lock. The file you locked will not be overwritten. ● Search locked file: Click the button  to view the locked file. 																		
8	Playback control pane.	<table border="1"> <tr> <td data-bbox="512 815 603 1061">▶/ </td> <td data-bbox="603 815 1568 1061"> Play/Pause  There are three ways for you to begin playback. <ul style="list-style-type: none"> ● The play button ● Double click the valid period of the time bar. ● Double click the item in the file list. In slow play mode, click it to switch between play/pause. </td> </tr> <tr> <td data-bbox="512 1061 603 1106">■</td> <td data-bbox="603 1061 1568 1106">Stop</td> </tr> <tr> <td data-bbox="512 1106 603 1272">◀</td> <td data-bbox="603 1106 1568 1272"> Backward play In normal play mode, left click the button, the file begins backward play. Click it again to pause current play. In backward play mode, click ▶/ to restore normal play. </td> </tr> <tr> <td data-bbox="512 1272 603 1480"> ◀/▶ </td> <td data-bbox="603 1272 1568 1480"> In playback mode, click it to play the next or the previous section. You can click continuously when you are watching the files from the same channel. In normal play mode, when you pause current play, you can click ◀ and ▶ to begin frame by frame playback. In frame by frame playback mode, click ▶/ to restore normal playback. </td> </tr> <tr> <td data-bbox="512 1480 603 1603">▶·</td> <td data-bbox="603 1480 1568 1603"> Slow play In playback mode, click it to realize various slow play modes such as slow play 1, slow play 2, and etc. </td> </tr> <tr> <td data-bbox="512 1603 603 1727">▶▶</td> <td data-bbox="603 1603 1568 1727"> Fast forward In playback mode, click to realize various fast play modes such as fast play 1, fast play 2 and etc. </td> </tr> <tr> <td colspan="2" data-bbox="512 1727 1568 1771">Note: The actual play speed has relationship with the software version.</td> </tr> <tr> <td data-bbox="512 1771 603 1850"></td> <td data-bbox="603 1771 1568 1850">Smart search</td> </tr> <tr> <td data-bbox="512 1850 603 1960"></td> <td data-bbox="603 1850 1568 1960">The volume of the playback</td> </tr> </table>	▶/	Play/Pause  There are three ways for you to begin playback. <ul style="list-style-type: none"> ● The play button ● Double click the valid period of the time bar. ● Double click the item in the file list. In slow play mode, click it to switch between play/pause.	■	Stop	◀	Backward play In normal play mode, left click the button, the file begins backward play. Click it again to pause current play. In backward play mode, click ▶/ to restore normal play.	◀/▶	In playback mode, click it to play the next or the previous section. You can click continuously when you are watching the files from the same channel. In normal play mode, when you pause current play, you can click ◀ and ▶ to begin frame by frame playback. In frame by frame playback mode, click ▶/ to restore normal playback.	▶·	Slow play In playback mode, click it to realize various slow play modes such as slow play 1, slow play 2, and etc.	▶▶	Fast forward In playback mode, click to realize various fast play modes such as fast play 1, fast play 2 and etc.	Note: The actual play speed has relationship with the software version.			Smart search		The volume of the playback
▶/	Play/Pause  There are three ways for you to begin playback. <ul style="list-style-type: none"> ● The play button ● Double click the valid period of the time bar. ● Double click the item in the file list. In slow play mode, click it to switch between play/pause.																			
■	Stop																			
◀	Backward play In normal play mode, left click the button, the file begins backward play. Click it again to pause current play. In backward play mode, click ▶/ to restore normal play.																			
◀/▶	In playback mode, click it to play the next or the previous section. You can click continuously when you are watching the files from the same channel. In normal play mode, when you pause current play, you can click ◀ and ▶ to begin frame by frame playback. In frame by frame playback mode, click ▶/ to restore normal playback.																			
▶·	Slow play In playback mode, click it to realize various slow play modes such as slow play 1, slow play 2, and etc.																			
▶▶	Fast forward In playback mode, click to realize various fast play modes such as fast play 1, fast play 2 and etc.																			
Note: The actual play speed has relationship with the software version.																				
	Smart search																			
	The volume of the playback																			

		 <p>Click the snapshot button in the full-screen mode, the system can snapshot 1 picture.</p> <p>System supports custom snap picture saved path. Please connect the peripheral device first, click snap button on the full-screen mode, you can select or create path. Click Start button, the snapshot picture can be saved to the specified path.</p>
		 <p>Mark button.</p> <p>Please note this function is for some series product only. Please make sure there is a mark button in the playback control pane.</p> <p>You can refer to chapter 4.7.1.3 for detailed information.</p>
9	Time bar	<ul style="list-style-type: none"> ● It is to display the record type and its period in current search criteria. ● In 4-window playback mode, there are corresponding four time bars. In other playback mode, there is only one time bar. ● Use the mouse to click one point of the color zone in the time bar, system begins playback. ● The time bar is beginning with 0 o'clock when you are setting the configuration. The time bar zooms in the period of the current playback time when you are playing the file. ● The green color stands for the regular record file. The red color stands for the external alarm record file. The yellow stands for the motion detect record file.
10	Time bar unit	<ul style="list-style-type: none"> ● The option includes: 24H, 2H, 1H and 30M. The smaller the unit, the larger the zoom rate. You can accurately set the time in the time bar to playback the record. ● The time bar is beginning with 0 o'clock when you are setting the configuration. The time bar zooms in the period of the current playback time when you are playing the file.
11	Backup	<ul style="list-style-type: none"> ● Select the file(s) you want to backup from the file list. You can check from the list. Then click the backup button, now you can see the backup menu. System supports customized path setup. After select or create new folder, click the Start button to begin the backup operation. The record file(s) will be saved in the specified folder. ● Check the file again you can cancel current selection. System max supports to display 32 files from one channel. ● After you clip on record file, click Backup button you can save it. ● For one device, if there is a backup in process, you cannot start a new backup operation.

12	Clip	<ul style="list-style-type: none"> ● It is to edit the file. ● Please play the file you want to edit and then click this button when you want to edit. You can see the corresponding slide bars in the time bar of the corresponding channel. You can adjust the slide bar or input the accurate time to set the file end time. ● After you set, you can click Clip button again to edit the second period. You can see the slide bar restore its previous position. ● Click Backup button after clip, you can save current contents in a new file. ● You can clip for one channel or multiple-channel. The multiple-channel click operation is similar with the one-channel operation. <p>Please note:</p> <ul style="list-style-type: none"> ● System max supports 1024 files backup at the same time. ● You cannot operate clip operation if there is any file has been checked in the file list.
13	Record type	In any play mode, the time bar will change once you modify the search type.
Other Functions		
14	Smart search	<ul style="list-style-type: none"> ● When system is playing, you can select a zone in the window to begin smart search. Click the motion detect button to begin play. ● Once the motion detect play has begun, click button again will terminate current motion detect file play. ● There is no motion detect zone by default. ● If you select to play other file in the file list, system switches to motion detect play of other file. ● During the motion detect play process, you cannot implement operations such as change time bar, begin backward playback or frame by frame playback. ● Please refer to chapter 4.7.1.1 Smart Search for detailed operation.
15	Other channel synchronization switch to play when playback	When playing the file, click the number button, system can switch to the same period of the corresponding channel to play.
16	Sync	In pane 13 of Figure 4-72, click Sync button, you can playback the files of different channels occurred at the same time.
17	Digital zoom	When the system is in full-screen playback mode, left click the mouse in the screen. Drag your mouse in the screen to select a section and then left click mouse to realize digital zoom. You can right click mouse to exit.

18	Manually switch channel when playback	During the file playback process, you can switch to other channel via the dropdown list or rolling the mouse. This function is null if there is no record file or system is in smart search process.
----	---------------------------------------	------------------------------------------------------------------------------------------------------------------------------------------------------------------------------------------------------

4.7.1.1 Smart Search

During the multiple-channel playback mode, double click one channel and then click the



button, system begins smart search. System supports 396(22*18 PAL) and 330(22*15 NTSC) zones. Please left click mouse to select smart search zones. See Figure 4-73.

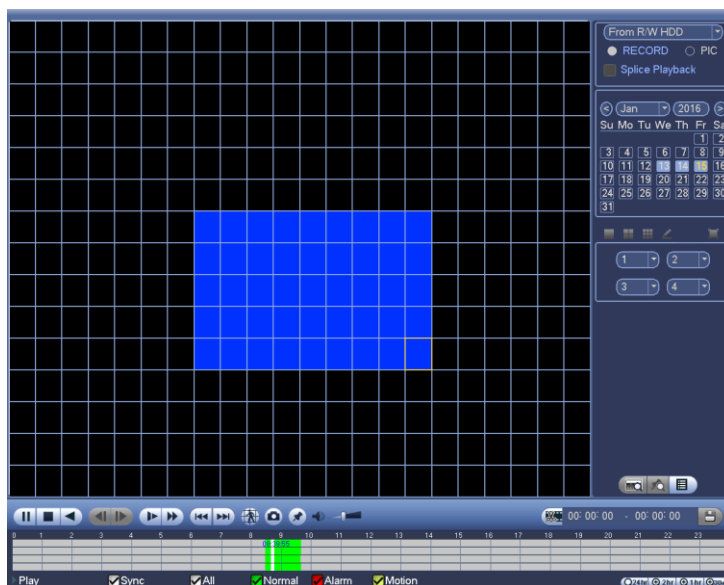



Figure 4-73

Click the , you can go to the smart search playback. Click it again, system stops smart search playback.

Note

- System does not support motion detect zone setup during the full-screen mode.
- During the multiple-channel playback, system stops playback of rest channels if you implement one-channel smart search.

4.7.1.2 Accurate playback by time

Select records from one day, click the list, you can go to the file list interface. You can input time at the top right corner to search records by time. See image on the left side of

the Figure 4-74 For example, input time 11:00.00 and then click Search button , you can view all the record files after 11:00.00 (The records includes current time.). See image on the right side of the Figure 4-74 Double click a file name to playback.

 **Note**

- After you searched files, system implement accurate playback once you click Play for the first time.
- System does not support accurate playback for picture.
- System supports synchronization playback and non-synchronous playback. The synchronization playback supports all channels and non-synchronous playback only supports accurately playback of current select channel.

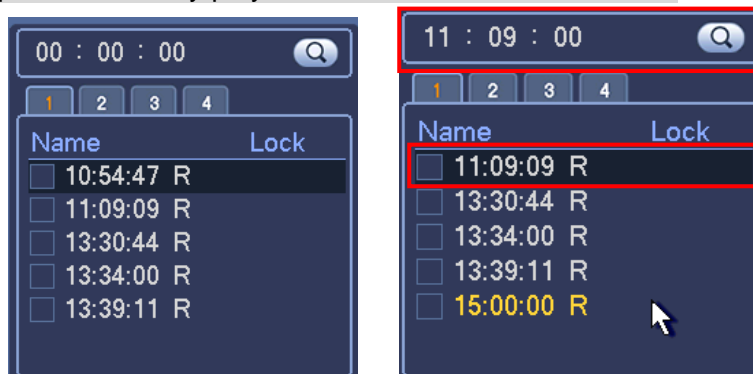

Figure 4-74

4.7.1.3 Mark Playback

Please make sure your purchased device support this function. You can use this function only if you can see the mark playback icon on the Search interface (Figure 4-72).

When you are playback record, you can mark the record when there is important information. After playback, you can use time or the mark key words to search corresponding record and then play. It is very easy for you to get the important video information.

- Add Mark



When system is playback, click Mark button , you can go to the following interface. See Figure 4-75.



Figure 4-75

- Playback Mark

During 1-window playback mode, click mark file list button  in Figure 4-72, you can go to mark file list interface. Double click one mark file, you can begin playback from the mark time.

- Play before mark time

Here you can set to begin playback from previous N seconds of the mark time.

Note

Usually, system can playbacks previous N seconds record if there is such kind of record file. Otherwise, system playbacks from the previous X seconds when there is such as kind of record.

- Mark Manager

Click the mark manager button  on the Search interface (Figure 4-72); you can go to Mark Manager interface. See Figure 4-76. System can manage all the record mark information of current channel by default. You can view all mark information of current channel by time.

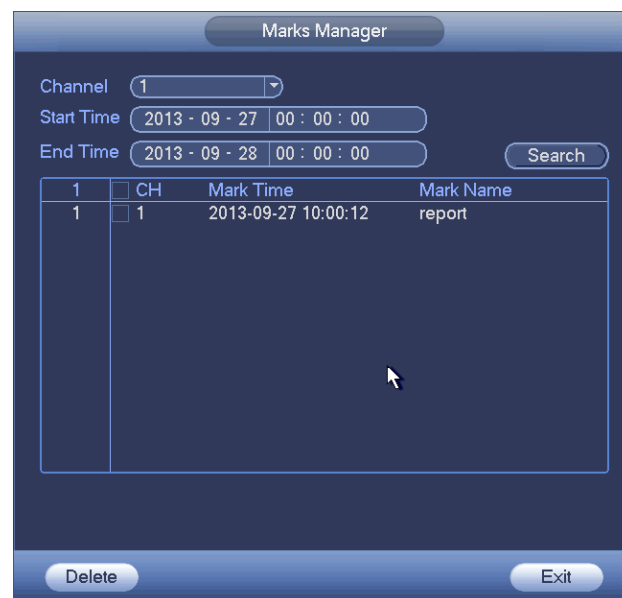

Figure 4-76

- Modify

Double click one mark information item, you can see system pops up a dialogue box for you to change mark information. You can only change mark name here.

- Delete

Here you can check the mark information item you want to delete and then click Delete button, you can remove one mark item. .

Note

- After you go to the mark management interface, system needs to pause current playback. System resume playback after you exit mark management interface.
- If the mark file you want to playback has been removed, system begins playback from the first file in the list.

4.7.1.4 Customized Playback

You can select one or more channel(s) to playback at the same time.
From main menu->Search or you can right click mouse on the preview interface and then select Search, you can go to Figure 4-72.



In pane 4, click , you can see the following interface. See Figure 4-77.



Figure 4-77

Now you can select one or more channel(s) and then click  to search record(s).

System supports one or more channels. The window split mode can auto adjust according to the channel amount. System max supports 16-split.

Click  button to select all channels at the same time.

Click , system begins playback.

4.7.1.5 Splice Playback

For the large record file, you can use splice playback function to play the same file in several sections at the same time. It is very convenient for you to find the video footages you desire.

On the main menu, click Search button, or right click mouse and then select Search. You can go to the Figure 4-72.

On the right pane, check the box to enable splice playback function, and then set channel, date, split mode. The splice playback interface is shown as below. Each section has a small triangle; you can adjust it to set time. See Figure 4-78.



Figure 4-78

Note

Select split mode, so that the record can be spliced in several sections.

Select splice file.

- Click Playback, system playbacks from the first of current date by default.
- Click time bar, system playbacks from the time you click.
- Click , you can select on the file list.

 **Note**

- The splice playback is for 1-window playback mode.
- System supports 1/4/8/16-split mode. Slight different may be found here.
- The min period of each section is 5 minutes. For the record is less than 20 minutes, if you select 4-split mode (or more than 4-split mode), system can auto adjust so that the each section period is 5 minutes. In this situation, some channel may have no video.

4.7.2 Human Face Search

On the preview window, right click mouse and then select face search, or from the main menu, click Face search, you can go to the following interface. See Figure 4-79.

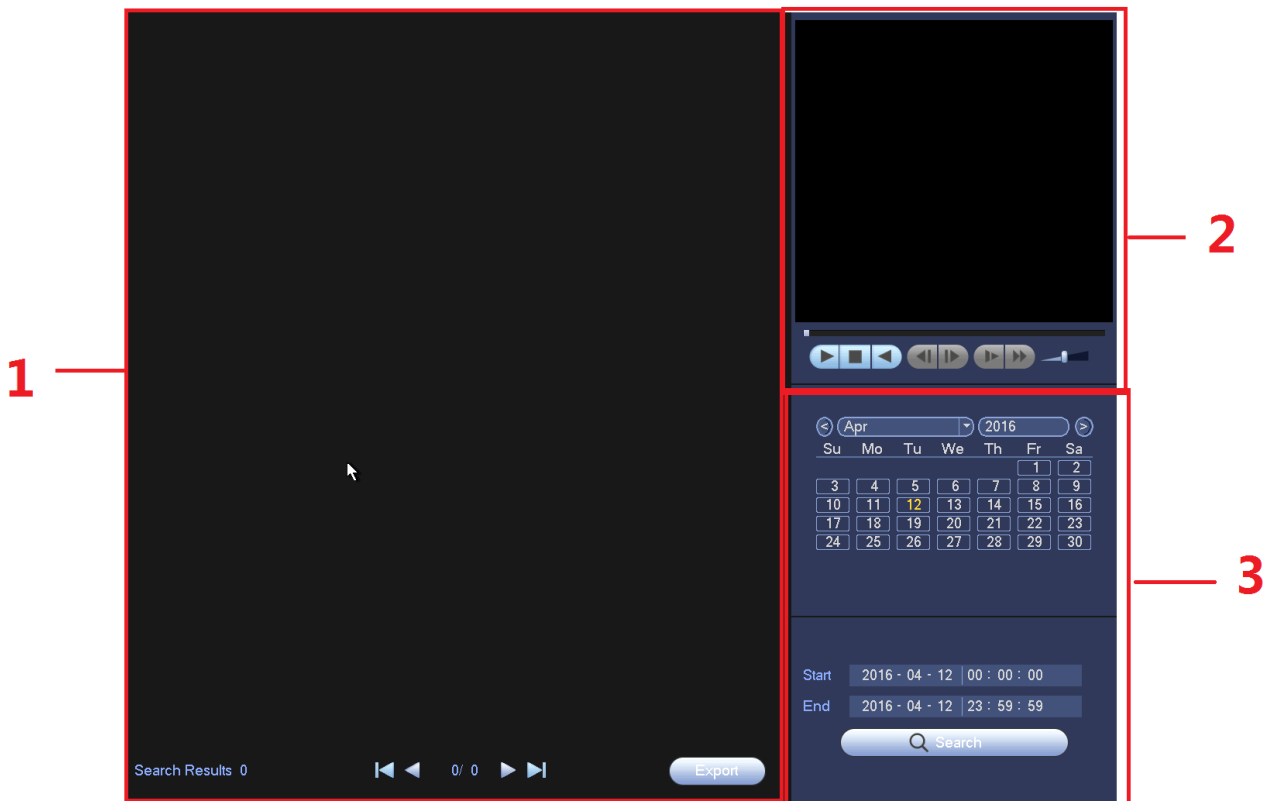

Figure 4-79

Please refer to the following sheet for detailed information.

SN	Name	Function
----	------	----------

SN	Name	Function
1	Display pan	<ul style="list-style-type: none"> It is to display human face detection file list. The latest file is at the top. \ Click Export, you can export the selected file to the USB device. There are two types: image/record. <ul style="list-style-type: none"> Image: Export the recognized human face image. Record: Export the record file before and after 10 seconds when the DVR recognizes the human face.
2	Playback pane	Play the searched record file or image. Double click to playback in full screen.
3	Search pane	Set date, start time and end time, click Search button, you can view the corresponding file list.

4.7.3 Backup

DVR support CD-RW, DVD burner, USB device backup, network download and eSATA. Here we introduce USB, eSATA backup. You can refer to Chapter 7 Web Client Operation for network download backup operation.

Click backup button, you can see an interface is shown as in Figure 4-80. Here is for you to view devices information.

You can view backup device name and its total space and free space. The device includes CD-RW, DVD burner, USB device, flash disk, eSATA backup.

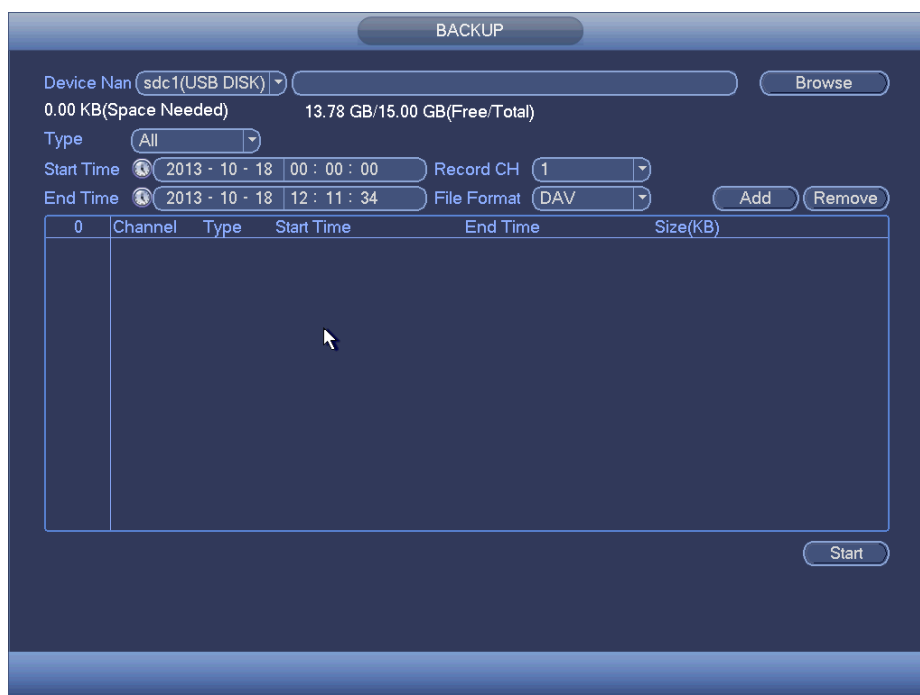

Figure 4-80

Select backup device and then set channel, file start time and end time.

Click add button, system begins search. All matched files are listed below. System automatically calculates the capacity needed and remained. See Figure 4-81.

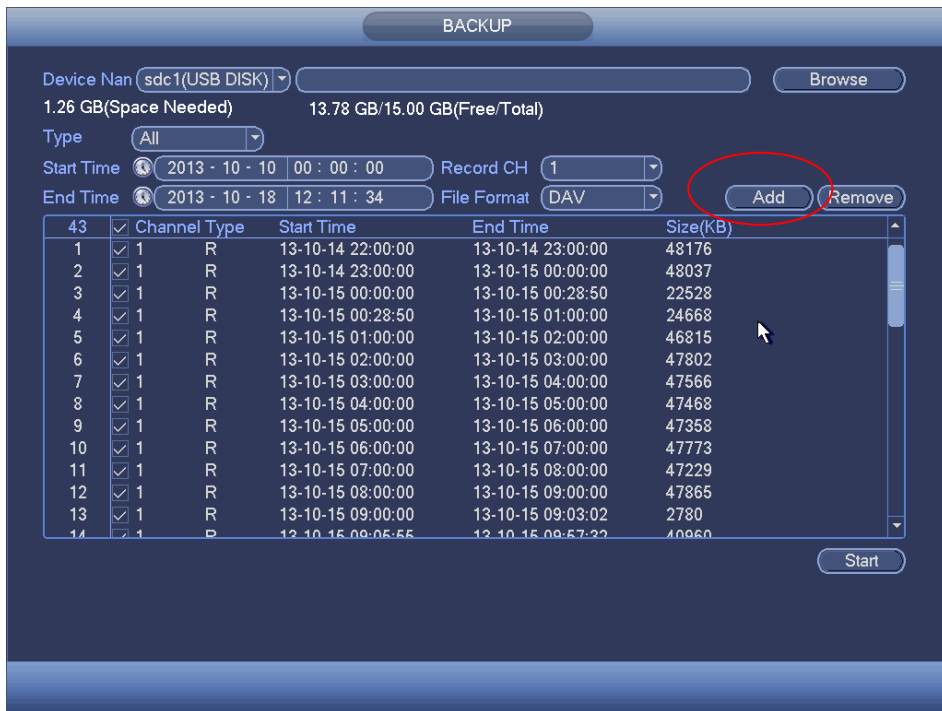

Figure 4-81

System only backup files with a before channel name. You can use Fn or cancel button to delete after file serial number.

Click Start button, system begins copy. At the same time, the backup button becomes stop button. You can view the remaining time and process bar at the left bottom. See Figure 4-82.

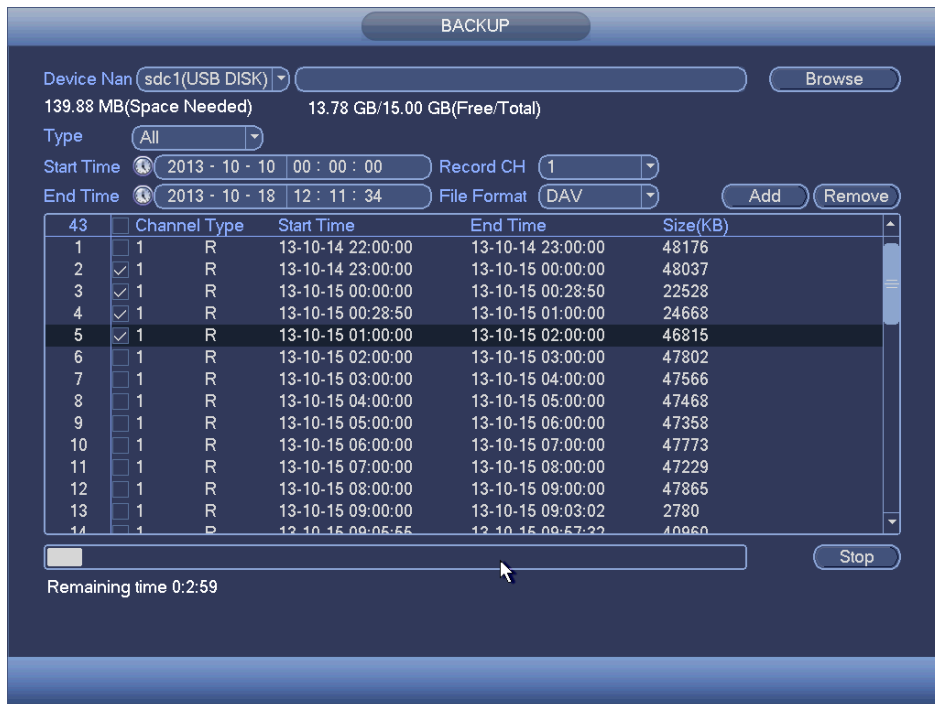

Figure 4-82

When the system completes backup, you can see a dialogue box prompting successful backup.

- File format: Click the file format; you can see there are two options: DAV/ASF. The file name format usually is: Channel number+Record type+Time. In the file name, the YDM format is Y+M+D+H+M+S. File extension name is .dav.

Tips:

During backup process, you can click ESC to exit current interface for other operation. The system will not terminate backup process.

 **Note**

When you click stop button during the burning process, the stop function becomes activated immediately. For example, if there are ten files, when you click stop system just backup five files, system only save the previous 5 files in the device (But you can view ten file names).

4.7.4 Shut Down

In Figure 4-71, select Shut Down, you can go to the following interface. See Figure 4-83.

There are three options: Shutdown/logout/reboot.

For the user who does not have the shut down right, please input corresponding password to shut down.



Figure 4-83

4.8 Information

4.8.1 System Info

Here is for you to view system information. There are total four items: HDD (hard disk information), record, BPS (data stream statistics), version. See Figure 4-84.



Figure 4-84

4.8.1.1 HDD Information

Here is to list hard disk type, total space, free space, video start time and status. See Figure 4-85.

- SATA: 1-2 here means system max supports 2 HDDS. o means current HDD is normal. X means there is error. - means there is no HDD. If disk is damaged, system shows as "?". Please remove the broken hard disk before you add a new one.
- SN: You can view the HDD amount the device connected to. * means the second HDD is current working HDD.
- Type: The corresponding HDD properties.
- Total space: The HDD total capacity.
- Free space: The HDD free capacity.
- Status: HDD can work properly or not.
- SMART: Display HDD information. See Figure 4-86.



Figure 4-85

Double click one HDD information; you can see the HDD SMART information. . See Figure 4-86.

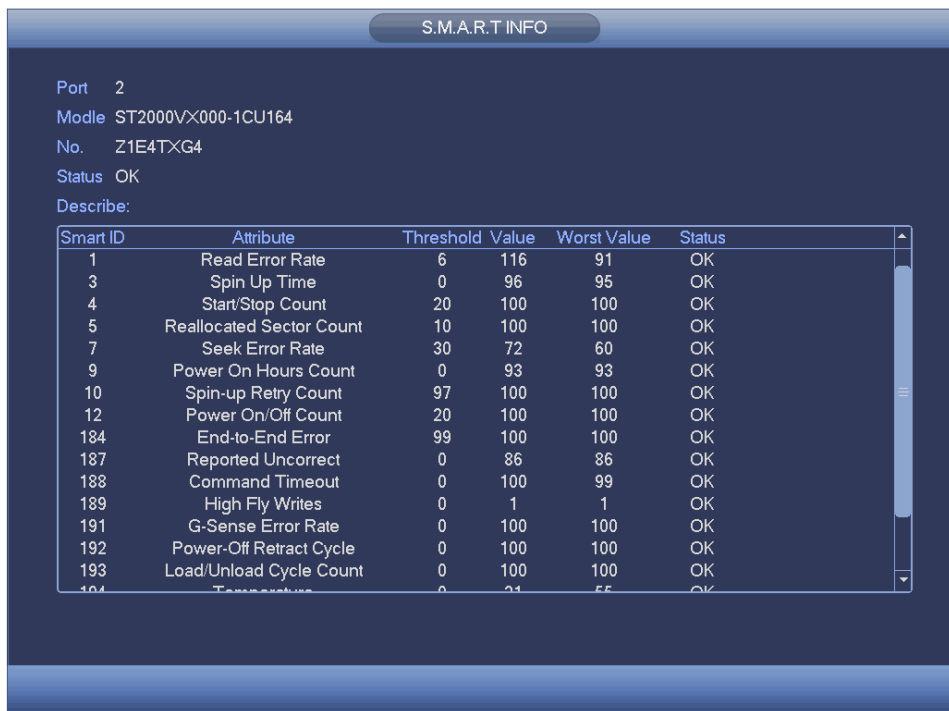

Figure 4-86

4.8.1.2 Record Info

It is to view record start time and end time. See Figure 4-87.

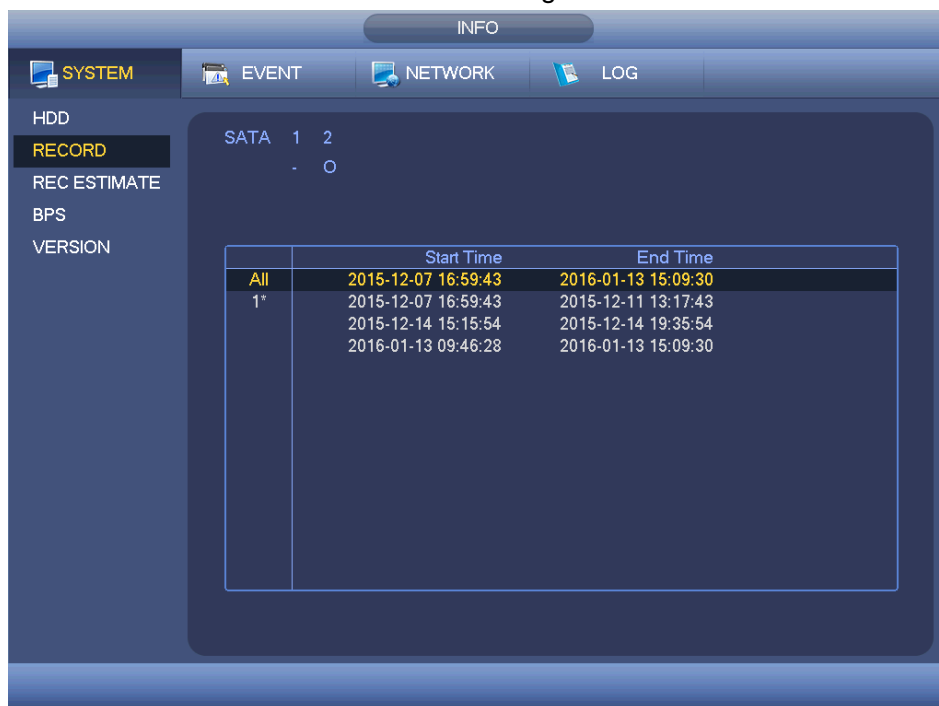



Figure 4-87

4.8.1.3 Record Estimate

System can calculate the record time based on the HDD space, or you can input the record time you want to calculate the HDD space you need. See Figure 4-88.



Figure 4-88

Click  after the channel name, system pops up Edit dialogue box. See Figure 4-89.

You can input resolution, frame rate, bit stream, record time of the corresponding channel, system can calculate the record time based on the channel setup and HDD space.



Figure 4-89

- **Calculate the record period based on the HDD space**

Check the channel you want to record file.

Click Known Space and then click the  button to set HDD. Click OK button. Now you can see the record period (such as 5 days). See Figure 4-90.



Figure 4-90

- **Calculate the HDD space based on the record period**

Check the channel you want to record file.

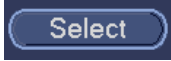
Input days(s) you want to records, system can auto calculate the HDD space needed (such as 5.109TB). See Figure 4-91.



Figure 4-91

4.8.1.4 BPS

Here is for you to view current video data stream (KB/s), resolution, etc. See Figure 4-92.

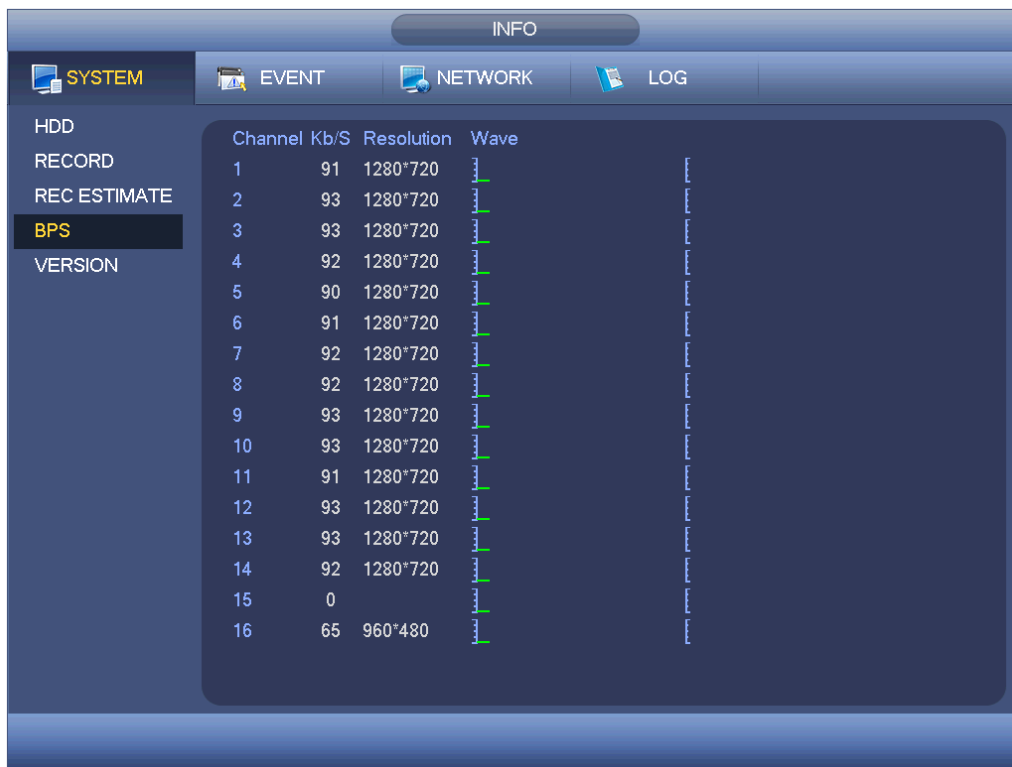

Figure 4-92

4.8.1.5 Channel

It is to view the connected camera information. See Figure 4-93.

 **Note**

Slight difference may be found on the user interface.

The format refers to the connected camera format.



Figure 4-93

4.8.1.6 Device Status



Note

This function is for some series product only.

It is to view fan status, power status, CPU usage, temperature and etc.

From main menu->Info->System->Status, enter device status interface. See Figure 4-94.



Figure 4-94

4.8.1.7 Version

Here is for you to view some version information such as version number, built date, serial number and etc.

4.8.2 Event

It is to display device status and channel status. See Figure 4-95.

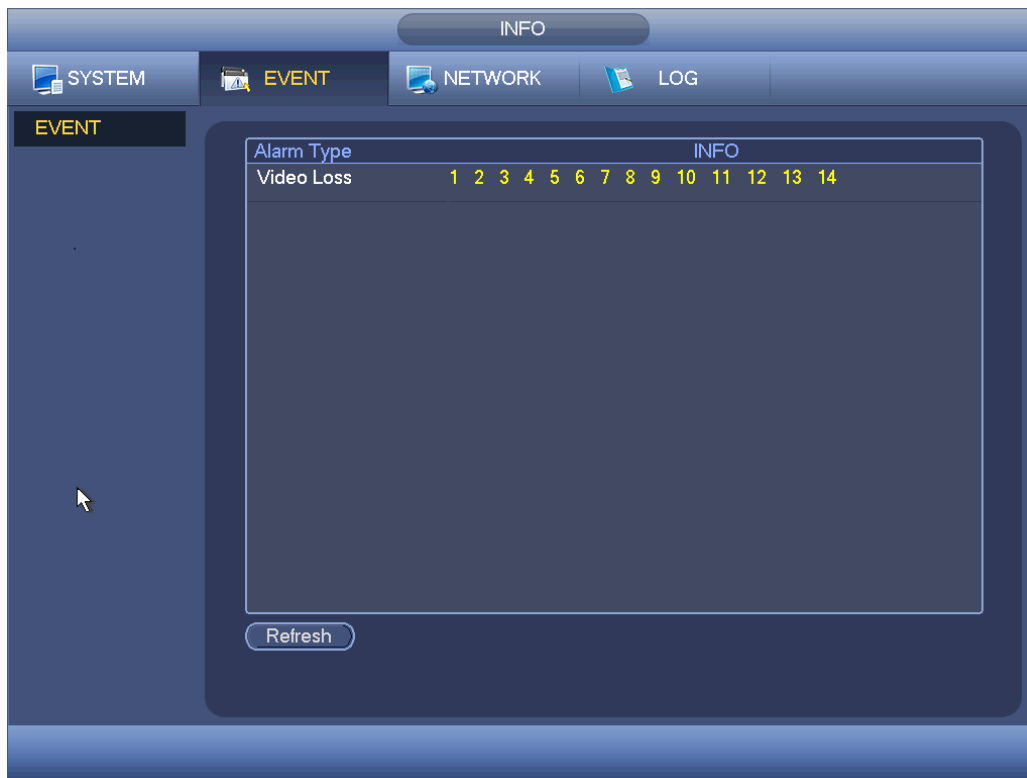

Figure 4-95

4.8.3 Network

4.8.3.1 Online Users

Here is for you to manage online users. See Figure 4-96.

You can disconnect one user or block one user if you have proper system right. Max disconnection setup is 65535 seconds.

System detects there is any newly added or deleted user in each five seconds and refresh the list automatically.

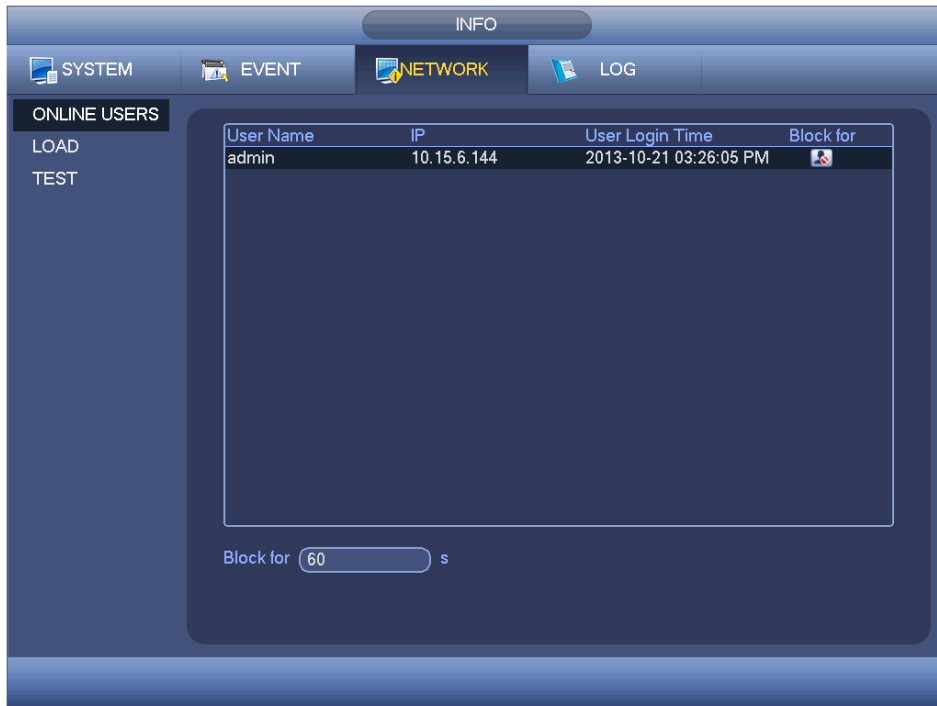

Figure 4-96

4.8.3.2 Network Load

Network load is shown as in Figure 4-97. Here you can view the follow statistics of the device network adapter.

Here you can view information of all connected network adapters. The connection status is shown as offline if connection is disconnected. Click one network adapter, you can view the flow statistics such as send rate and receive rate at the top panel.

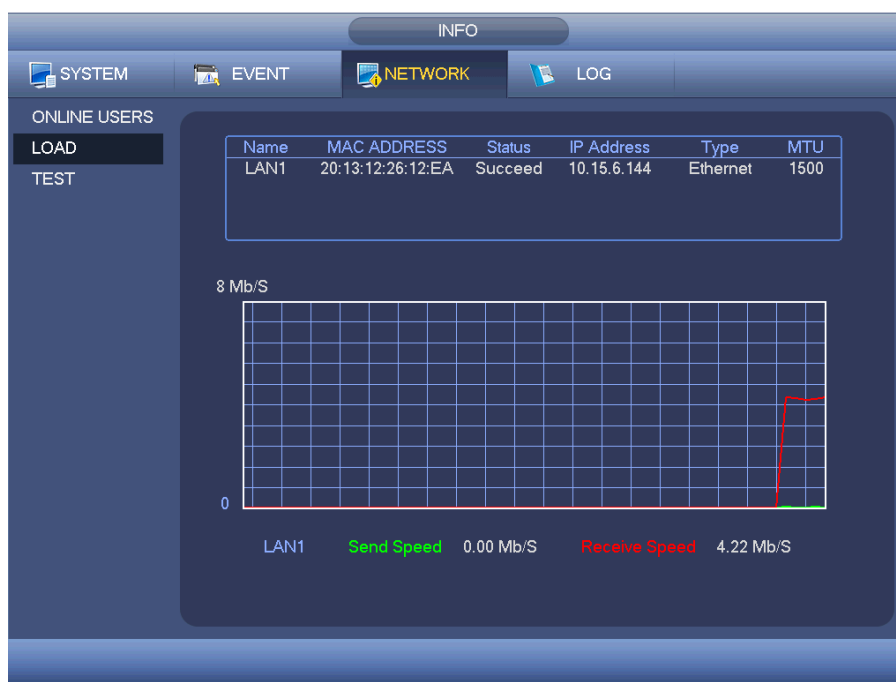



Figure 4-97

4.8.3.3 Network Test

Network test interface is shown as in Figure 4-98.

- Destination IP: Please input valid IPV4 address or domain name.
- Test: Click it to test the connection with the destination IP address. The test results can display average delay and packet loss rate and you can also view the network status as OK, bad, no connection and etc.
- Network Sniffer backup: Please insert USB2.0 device and click the Refresh button, you can view the device on the following column. You can use the dropdown list to select peripheral device. Click Browse button to select the snap path. The steps here are same as preview backup operation.

You can view all connected network adapter names (including Ethernet, PPPoE, WIFI, and 3G), you can click the button  on the right panel to begin Sniffer. Click the grey stop button to stop. Please note system cannot Sniffer several network adapters at the same time.

After Sniffer began, you can exit to implement corresponding network operation such as login WEB, monitor. Please go back to Sniffer interface to click  stop Sniffer. System can save the packets to the specified path. The file is named after "Network adapter name+time". You can use software such as Wireshark to open the packets on the PC for the professional engineer to solve complicated problems.

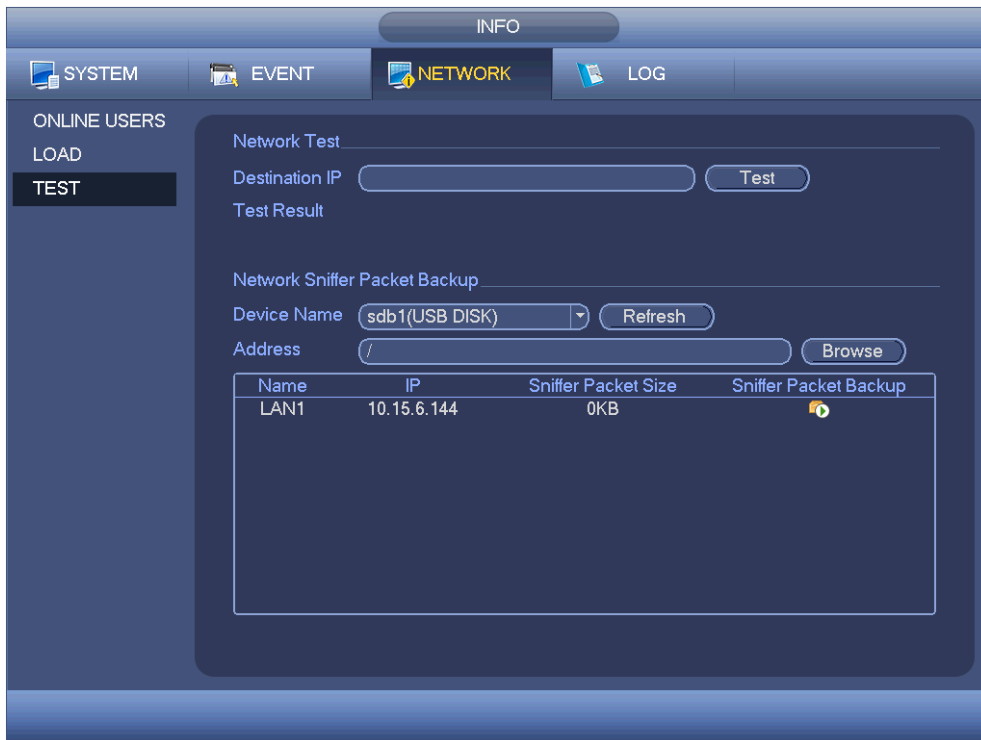

Figure 4-98

4.8.4 Log

4.8.4.1 Local Log

Here is for you to view system log file. System lists the following information. See Figure 4-99.

Log types include system operation, configuration operation, data management, alarm event, record operation, account manager, log clear, file operation and etc. It optimized reboot log. There are only three types: normal reboot, abnormal reboot and protection reboot. 0x02、0x03、0x04 is included in the protection reboot type.

- Start time/end time: Pleased select start time and end time, then click search button. You can view the log files in a list. System max displays 100 logs in one page. It can max save 1024 log files. Please use page up/down button on the interface or the front panel to view more.
- Backup: Please select a folder you want to save; you can click the backup button to save the log files. After the backup, you can see there is a folder named Log_time on the backup path. Double click the folder, you can see the log file
- Details: Click the Details button or double click the log item, you can view the detailed information. See Figure 4-100. Here you can use rolling bar to view information, or you can use Page up/Page down to view other log information.

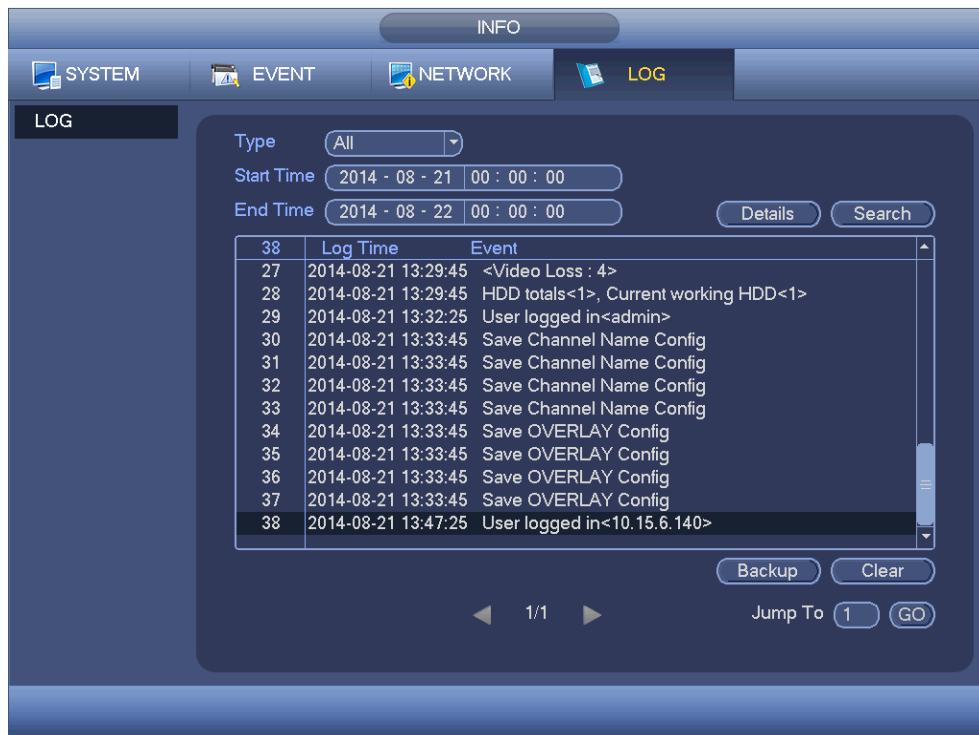

Figure 4-99

Select an item on the list and then click the Details button or double click the log item, you can view the detailed information such as log time, log type, log user, IP address and etc. See Figure 4-100.



Figure 4-100

Note

- If there is no HDD, system max supports 1024 logs.
- If you have connected to the unformatted HDD, system max supports 5000 logs.
- If you have connected to the formatted HDD, system max supports 500,000 logs.
- System operation logs are saved in system memory. Other types of logs are saved in the HDD. If there is no HDD, other types of logs are saved in the system memory too.
- The logs are safe when you format the HDD. But the logs may become loss once you removed the HDD.

4.9 Setting

4.9.1 Camera

4.9.1.1 Remote Device (For digital channel only)

4.9.1.1.1 Remote Device

In the main menu, from Camera ->Registration, you can go to Registration interface. Here you can add/delete remote device and view its corresponding information.

Refer to chapter 4.1.4.4 Registration for detailed information.

4.9.1.1.2 Channel Status

Here you can view the IPC status of the corresponding channel such as motion detect, video loss, tampering, alarm and etc. See Figure 4-101.





- IPC status: : Front-end does not support. : Front-end supports. : There is alarm event from current front-end.
- Connection status: : Connection succeeded. : Connection failed.
- Refresh: Click it to get latest front-end channel status.



Figure 4-101

4.9.1.1.3 Firmware

It is to view channel, IP address, manufacturer, type, system version, SN, video input, audio input, and etc. See Figure 4-102.



Figure 4-102

4.9.1.2 Image

For analog channel, the camera interface is shown as in Figure 4-103. For digital channel, the camera interface is shown as in Figure 4-104.

- Channel: Select a channel from the dropdown list.
- Cable type: It is to set the cable type of the corresponding analog channel. When the setup here matches the actual cable you are using, you can get the best image effect. The default setup is COAXIAL. Please note this function is for some series products only.
 - ✧ COAXIAL: When the corresponding channel is using coaxial cable, please select COAXIAL.
 - ✧ UTP: When the corresponding channel is using UTP cable, please select UTP. Usually we recommend 100ohm UTP cable.
- Saturation: It is to adjust monitor window saturation. The value ranges from 0 to 100. The default value is 50. The larger the number, the strong the color is. This value has no effect on the general brightness of the whole video. The video color may become too strong if the value is too high. For the grey part of the video, the distortion may occur if the white balance is not accurate. Please note the video may not be attractive if the value is too low. The recommended value ranges from 40 to 60.
- Brightness: It is to adjust monitor window bright. The value ranges from 0 to 100. The default value is 50. The larger the number is, the bright the video is. When you input the value here, the bright section and the dark section of the video will be adjusted accordingly. You can use this function when the whole video is too dark or too bright. Please note the video may become hazy if the value is too high. The recommended value ranges from 40 to 60.

- Contrast: It is to adjust monitor window contrast. The value ranges from 0 to 100. The default value is 50. The larger the number is, the higher the contrast is. You can use this function when the whole video bright is OK but the contrast is not proper. Please note the video may become hazy if the value is too low. If this value is too high, the dark section may lack brightness while the bright section may over exposure .The recommended value ranges from 40 to 60.
- Sharpness: The value here is to adjust the edge of the video. The value ranges from 0 to 100. The larger the value is, the clear the edge is and vice versa. Please note there is noise if the value here is too high. The default value is 50 and the recommended value ranges from 40 to 60.
- Mirror: It is to switch video up and bottom limit. This function is disabled by default.
- Flip: It is to switch video left and right limit. This function is disabled by default.
- BLC:It includes several options: BLC/WDR/HLC/OFF.
- ✧ BLC: The device auto exposures according to the environments situation so that the darkest area of the video is cleared
- ✧ WDR: For the WDR scene, this function can lower the high bright section and enhance the brightness of the low bright section. So that you can view these two sections clearly at the same time. The value ranges from 1 to 100. When you switch the camera from no-WDR mode to the WDR mode, system may lose several seconds record video.
- ✧ HLC: After you enabled HLC function, the device can lower the brightness of the brightest section according to the HLC control level. It can reduce the area of the halo and lower the brightness of the whole video.
- ✧ OFF: It is to disable the BLC function. Please note this function is disabled by default.
- Profile: It is to set the white balance mode. It has effect on the general hue of the video. This function is on by default. You can select the different scene mode such as auto, sunny, cloudy, home, office, night, disable and etc to adjust the video to the best quality.
- ✧ Auto: The auto white balance is on. System can auto compensate the color temperature to make sure the vide color is proper.
- ✧ Sunny: The threshold of the white balance is in the sunny mode.
- ✧ Night: The threshold of the white balance is in the night mode.
- ✧ Customized: You can set the gain of the red/blue channel. The value reneges from 0 to 100.
- Day/night. It is to set device color and the B/W mode switch. The default setup is auto.
- ✧ Color: Device outputs the color video.
- ✧ Auto: Device auto select to output the color or the B/W video according to the device feature (The general bright of the video or there is IR light or not.)
- ✧ B/W: The device outputs the black and white video.
- ✧ Sensor: It is to set when there is peripheral connected IR light.
- Image enhancement: It is to enhance video quality. The larger the value is, the clearer the video is. But the noise may become large too.
- 2D NR: It is to process the noise of the single image. The video may become soft after process. The larger the value is, the better the effect is.

- 3D NR: it is to process the multiple-frame (at least two frames). It is to use the frame information between the following two frames to reduce noise. The larger the value is, the better the effect is.



Figure 4-103



Figure 4-104

4.9.1.3 Encode

It is to set video bit stream, picture bit stream, video overlay parameter and etc.

4.9.1.3.1 Video

Video setting includes the following items. See Figure 4-105.

- Channel: Select the channel you want.
- SVC: SVC is so called scaled video coding. Check the box to enable this function. During the network transmission process, system discards unimportant frames when the bandwidth is not sufficient or the decode capability is low. It is to guarantee video quality and transmission fluency.
- Type: Please select from the dropdown list. There are three options: regular/motion detect/alarm. You can set the various encode parameters for different record types.
- Compression: System supports H.264H, H.264, H.264B, and MJPEG.
 - ◇ H.264H: It is the High Profile compression algorithm. It has the high encode compression rate. It can achieve high quality encode at low bit stream. Usually we recommend this type.
 - ◇ H.264 is the general compression algorithm.
 - ◇ H.264B is the Baseline algorithm. Its compression rate is low. For the same video quality, it has high bit stream requirements.
- Smart codec: Select Start from the dropdown list to enable smart codec function. The DVR can auto reduce the video bit stream of the non-important surveillance object to save the storage space.
- Resolution: For analog channel, system supports various resolutions, you can select from the dropdown list. Please note the option may vary due to different series. For digital channel, the resolution here refers to the capability of the network camera.
- Frame rate: It ranges from 1f/s to 25f/s in NTSC mode and 1f/s to 30f/s in PAL mode.
- Bit rate type: System supports two types: CBR and VBR. In VBR mode, you can set video quality.
- Quality: There are six levels ranging from 1 to 6. The sixth level has the highest image quality.
- Video/audio: You can enable or disable the video/audio.
- Audio format: Please select from the dropdown list. There are three options: G711a/G711u/PCM.
- Audio source: Please select from the dropdown list. There are two options: local/HDCVI. For local mode, the audio signal is from the Audio In port. For HDCVI mode, the audio signal is from the coaxial cable of the camera.



Figure 4-105

4.9.1.3.2 Snapshot

Here you can set snapshot mode, picture size, quality and frequency. See Figure 4-106.

- Snapshot mode: There are two modes: regular and trigger. If you set timing mode, you need to set snapshot frequency. If you set trigger snapshot, you need to set snapshot activation operation.
- Image size: Here you can set snapshot picture size.
- Image quality: Here you can set snapshot quality. The value ranges from 1 to 6.
- Interval: It is for you to set timing (schedule) snapshot interval.



Figure 4-106

4.9.1.3.3 Overlay

Overlay interface is shown as in Figure 4-107.

- Cover area: Here is for you to set cover area. You can drag you mouse to set proper section size. In one channel video, system max supports 4 zones in one channel.
- Preview/monitor: privacy mask has two types. Preview and Monitor. Preview means the privacy mask zone cannot be viewed by user when system is in preview status. Monitor means the privacy mask zone cannot be view by the user when system is in monitor status.
- Time display: You can select system displays time or not when you playback. Please click set button and then drag the title to the corresponding position in the screen.
- Channel display: You can select system displays channel number or not when you playback. Please click set button and then drag the title to the corresponding position in the screen.
- Copy:After you complete the setup, you can click Copy button to copy current setup to other channel(s). You can see an interface is shown as in Figure 4-108. You can see current channel number is grey. Please check the number to select the channel or you can check the box ALL. Please click the OK button in Figure 4-108 and Figure 4-107 respectively to complete the setup.

Please highlight icon  to select the corresponding function.



Figure 4-107



Figure 4-108

4.9.1.3.4 Channel Name

It is to modify channel name. It max supports 31-character. See Figure 4-109.

Please note for digital channel, you can only modify the channel name of the connected network camera.



Figure 4-109

4.9.1.3.5 Channel Type

It is to set channel type.

- For analog channel (CVBS signal or HDCVI HD signal), you can select coaxial cable or UTP cable. Please check first and then save setup. There is no need to reboot.
- You can switch analog channel type to digital channel type if you want to connect to network camera. The IP channel shall start from the last channel. System needs to reboot to activate current setup.

Note

If there is no connected channel, the channel type here just displays previous connection record. System supports self-adaptive after camera connection.

The interface is shown as in Figure 4-110 (XVR series product) or Figure 4-111 (HCVR series product).

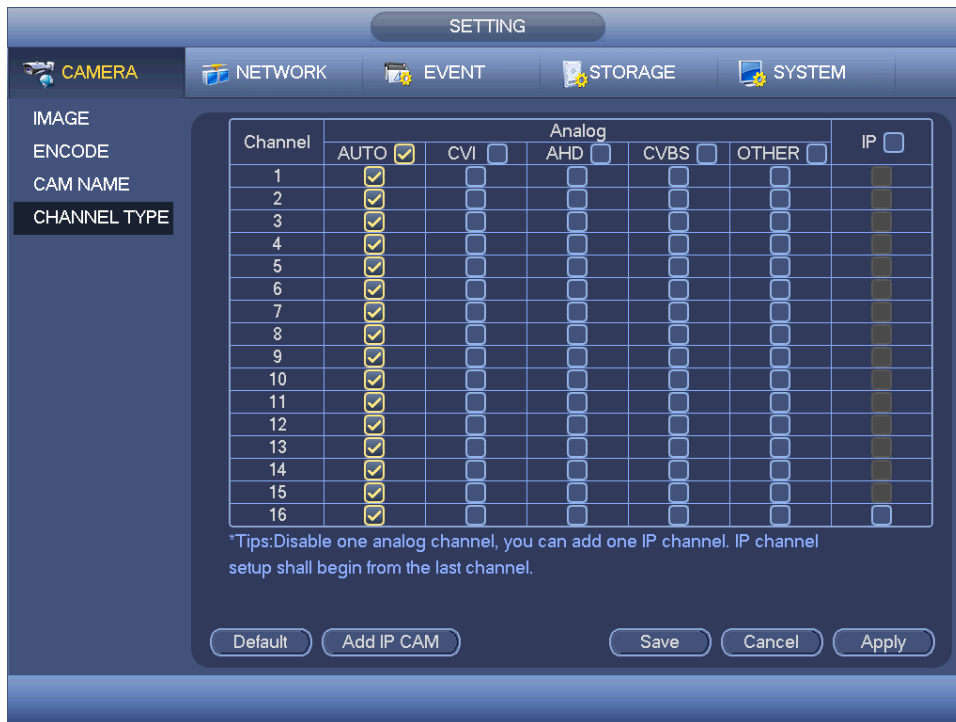

Figure 4-110



Figure 4-111



Important notice about XVR series product:

- Nowadays, there are mainly two analog signal types on today market: analog

standard definition (CVBS) and analog HD (CVI, AHD or Other). For XVR series product, each channel supports all types of signal connection (analog signal/IP signal). For analog signal connection, the default setup is AUTO, that is to say, no matter what analog signal (CVBS, CVI, AHD or other analog HD signal) connected; the XVR can automatically recognize the signal and display the proper image. There is no need to set manually.

- If the auto recognition error occurred, XVR series product supports manual setup too. The manual setup featuring high recognition speed and usually there is no error. For example, in Figure 4-112, you can set channel 1 to connect to CVI camera, channel 2 to connect to AHD camera, channel 3 to connect to CVBS camera.

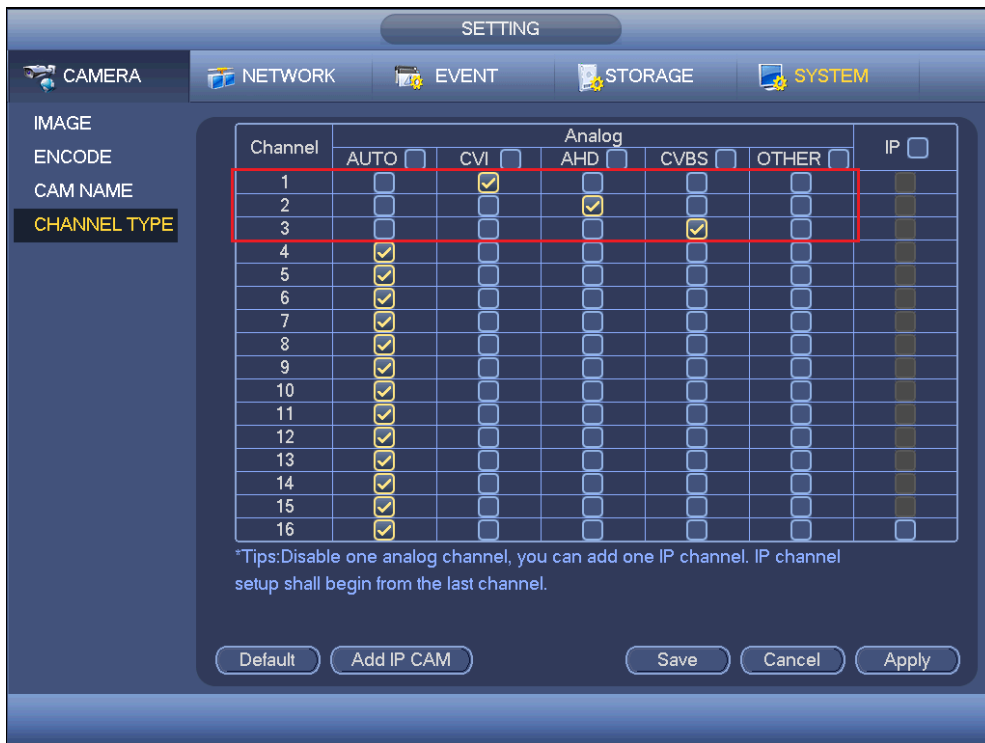

Figure 4-112

Important

Add/cancel IP CAM function is for some 4/8/16-channel series product only.

- Add IP CAM: Click it; you can add corresponding X IP channels. Here X refers to the product channel amount such as 4/8/16. System needs to restart to activate new setup. See Figure 4-113 (XVR series product) or Figure 4-114 (HCVR series product).



Figure 4-113

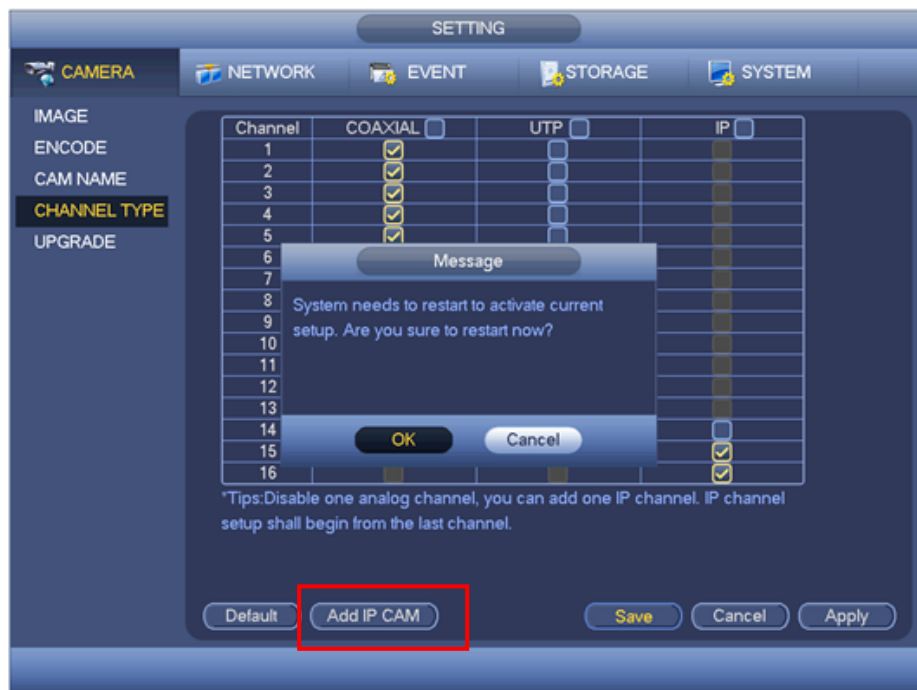

Figure 4-114

For example, there is a 4-channel analog device, after the A/D switch, it can max supports 4 analog channels and 4 IP channels. Once it has become the 3+1 mode (3 analog channels+1 IP channel), you click **Add IP CAM** button, system becomes 3+5 mode (3 analog channels+5 IP channel).

- Cancel IP CAM: Click it, you can cancel IP channel. System needs to restart to

restore original status.

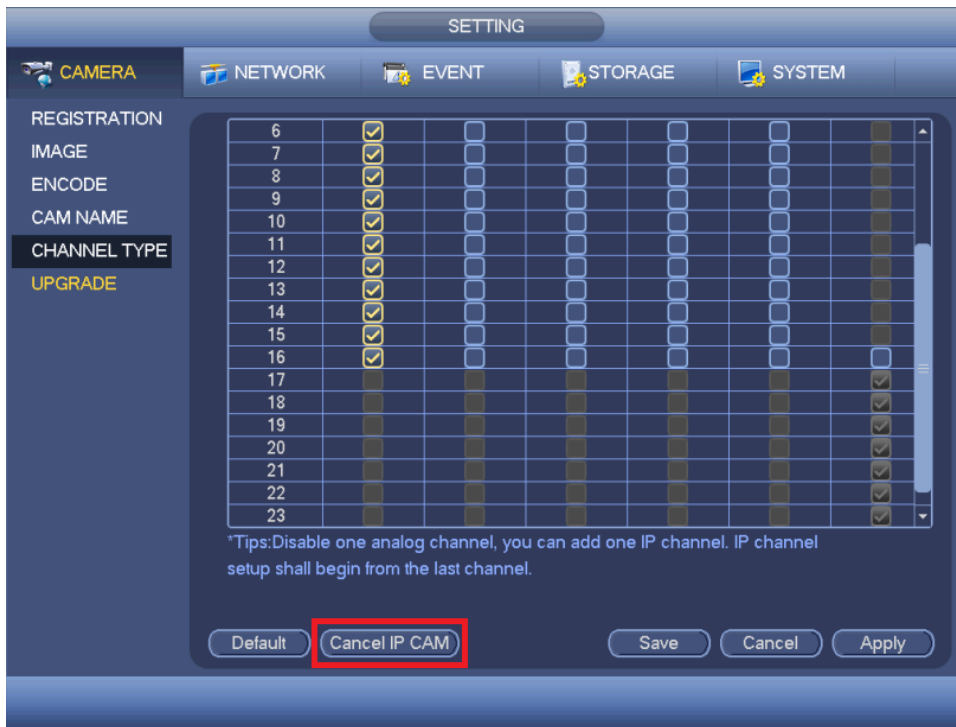

Figure 4-115

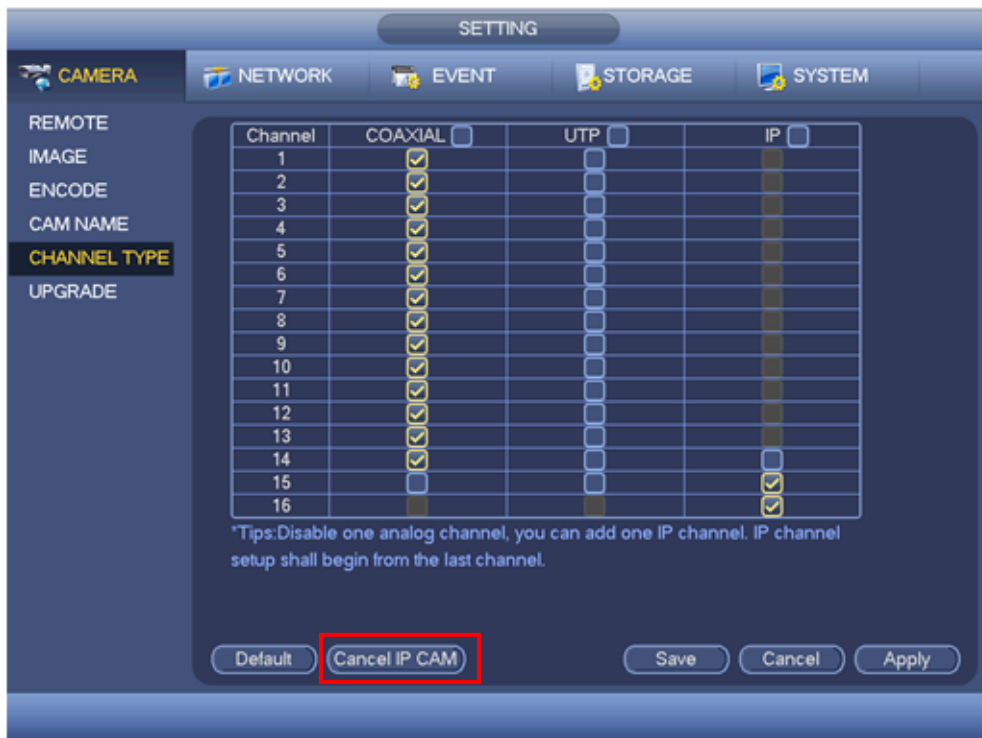

Figure 4-116

4.9.1.3.1 Upgrade Camera
It is to update the online camera.

From main menu->setting->camera->remote upgrade, the interface is shown as below. See Figure 4-117.

Online Upgrade

- Step 1 Select a remote device and then click the Detect button on the right side, or check a box to select a remote device and then click Manual Check.
System detects the new version on the cloud.
- Step 2 Select a remote device that has new version and then click online upgrade.
After successful operation, system pops up upgrade successful dialogue box.

File upgrade

- Step 1 Select a channel and then click File upgrade.
- Step 2 Select upgrade file on the pop-up interface.
- Step 3 Select the upgrade file and then click OK button.
After successful operation, system pops up upgrade successful dialogue box.

Note

If there are too much remote devices, select device type from the drop-down list to search the remote device you desire.



Figure 4-117

4.9.2 Network

4.9.2.1 TCP/IP

The single network adapter interface is shown as in Figure 4-118 and the dual network adapters interface is shown as in Figure 4-119

- Network Mode : Includes multiple access, fault tolerance, and load balancing
 - ✧ Multiple-address mode: eth0 and eth1 operate separately. You can use the services such as HTTP, RTP service via eth0 or the eth1. Usually you need to set one default card (default setup is eth0) to request the auto network service from the device-end such as DHCP, email, FTP and etc. In multiple-address mode, system network status is shown as offline once one card is offline.
 - ✧ Network fault-tolerance: In this mode, device uses bond0 to communicate with the external devices. You can focus on one host IP address. At the same time, you need to set one master card. Usually there is only one running card (master card). System can enable alternate card when the master card is malfunction. The system is shown as offline once these two cards are both offline. Please note these two cards shall be in the same LAN.
 - ✧ Load balance: In this mode, device uses bond0 to communicate with the external device. The eth0 and eth1 are both working now and bearing the network load. Their network load are general the same. The system is shown as offline once these two cards are both offline. Please note these two cards shall be in the same LAN.
- Default Network Card: Please select eth0/eth1/bond0(optional) after enable multiple-access function
- Main Network Card: Please select eth0/eth1 (optional).after enable multiple access function.

Note: Some series support the above three configurations and supports functions as multiple-access, fault-tolerance and load balancing.

- IP Version: There are two options: IPv4 and IPv6. Right now, system supports these two IP address format and you can access via them.
- MAC address: The host in the LAN can get a unique MAC address. It is for you to access in the LAN. It is read-only.
- IP address: Here you can use up/down button (▲▼) or input the corresponding number to input IP address. Then you can set the corresponding subnet mask the default gateway.
- Default gateway: Here you can input the default gateway. Please note system needs to check the validity of all IPv6 addresses. The IP address and the default gateway shall be in the same IP section. That is to say, the specified length of the subnet prefix shall have the same string.
- DHCP: It is to auto search IP. When enable DHCP function, you cannot modify IP/Subnet mask /Gateway. These values are from DHCP function. If you have not enabled DHCP function, IP/Subnet mask/Gateway display as zero. You need to disable DHCP function to view current IP information. Besides, when PPPoE is operating, you cannot modify IP/Subnet mask /Gateway.
- MTU: It is to set MTU value of the network adapter. The value ranges from 1280-7200 bytes. The default setup is 1500 bytes. Please note MTU modification may result in

network adapter reboot and network becomes off. That is to say, MTU modification can affect current network service. System may pop up dialog box for you to confirm setup when you want to change MTU setup. Click OK button to confirm current reboot, or you can click Cancel button to terminate current modification. Before the modification, you can check the MTU of the gateway; the MTU of the DVR shall be the same as or is lower than the MTU of the gateway. In this way, you can reduce packets and enhance network transmission efficiency.

The following MTU value is for reference only.

- ◇ 1500: Ethernet information packet max value and it is also the default value. It is the typical setup when there is no PPPoE or VPN. It is the default setup of some router, switch or the network adapter.
- ◇ 1492: Recommend value for PPPoE.
- ◇ 1468: Recommend value for DHCP.
- Preferred DNS server: DNS server IP address.
- Alternate DNS server: DNS server alternate address.
- Transfer mode: Here you can select the priority between fluency/video qualities.
- LAN download: System can process the downloaded data first if you enable this function. The download speed is 1.5X or 2.0X of the normal speed.

Click Apply or Save to complete setup.



Figure 4-118



Figure 4-119

4.9.2.2 Connection

The connection setup interface is shown as in Figure 4-120.

- Max connection: The max login client amount (WEB, platform, cellphone and etc.).The value ranges from 1 to 128. The default setup is 128.
- TCP port: Default value is 37777.
- UDP port: Default value is 37778.
- HTTP port: Default value is 80.
- HTTPS port: Default value is 443.
- RTSP port: Default value is 554.

Important: System needs to reboot after you changed and saved any setup of the above five ports. Please make sure the port values here do not conflict.

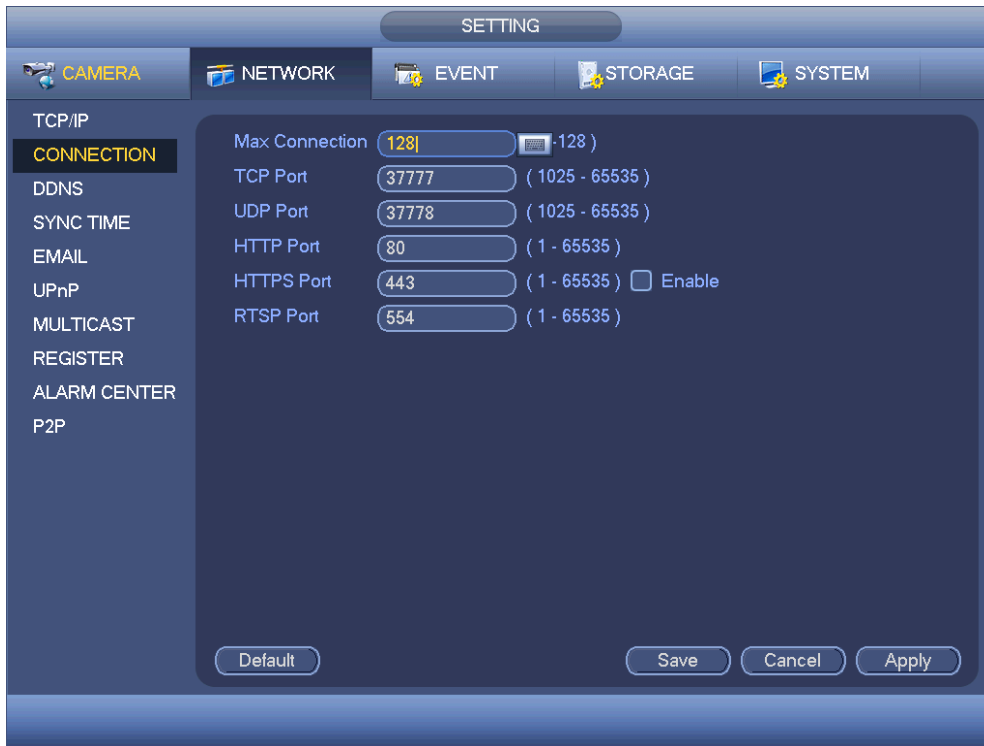

Figure 4-120

4.9.2.3 WIFI

Note

This function is for some series products only.

After setting WIFI, device can connect network camera via WIFI. There is no need to connect network cable. It can lower device installation difficulty and is convenient to use the device.

Step 1 From main menu->Setting->Network->WIFI.

Enter WIFI interface. See Figure 4-121.

Step 2 Set parameters.

- Auto connect WIFI: Check the box here, system automatically connects to the previous WIFI hotspot.
- Refresh: You can click it to search the hotspot list again. It can automatically add the information such as the password if you have set it before.
- Disconnect: Here you can click it to turn off the connection.
- Connect: Here you can click it to connect to the hotspot. System needs to turn off current connection and then connect to a new hotspot if there is connection of you selected one.
- WIFI working status: Here you can view current connection status.



Figure 4-121

Step 3 Click Apply or Save to complete setup.



Note

After successful connection, you can see WIFI connection icon at the top right corner of the preview interface.

After device successfully connected to the WIFI, you can view the hotspot name, IP address, subnet mask, default gateway and etc.

4.9.2.4 3G/4G



Note

This function is for some series products only.

Step 1 From main menu->Setting->Network->3G/4G.
Enter 3G/4G setup interface. See Figure 4-122.

Step 2 Set parameters.

- Pane 1: Display 3G/4G signal intensity after you enabled 3G/4G function.
 - Pane 2: Display 3G/4G module configuration information after you enabled 3G/4G function.
 - Pane 3: Display 3G/4G module status information after you enabled 3G/4G function.
- It is to display current wireless network signal intensity such as EVDO, CDMA1x, WCDMA, WCDMA, EDGE and etc.

- 3G/4G module: It is to display current wireless network adapter name.
- 3G/4G Enable/Disable: Check the box here to enable 3G/4G module.
- Network type: There are various network types for different 3G/4G network modules. You can select according to your requirements.
- APN: It is the wireless connection server. It is to set you access the wireless network via which method.
- AUTH: It is the authentication mode. It supports PAP/CHAP.
- Dial number: Please input 3G/4G network dialup number you got from your ISP.
- User name: It is the user name for you to login the 3G/4G network.
- Password: It is the password for you to login the 3G/4G network.
- Pulse interval: You can set dialup duration. Once you disable the extra stream, the connection time begins. For example, if you input 5 seconds here, then 3G/4G network connection period is 5 seconds. The device automatically disconnect when time is up. If there is no extra stream, 3G/4G network connection is valid all the time. **If the alive time is 0, then the 3G/4G network connection is valid all the time.**
- Dial: Here you can enable or disable 3G/4G network connection/disconnection manually.
- 3G/4G wireless network: Here is to display wireless network status, SIM card status, dial status. If the 3G/4G connection is OK, then you can see the device IP address the wireless network automatically allocates.

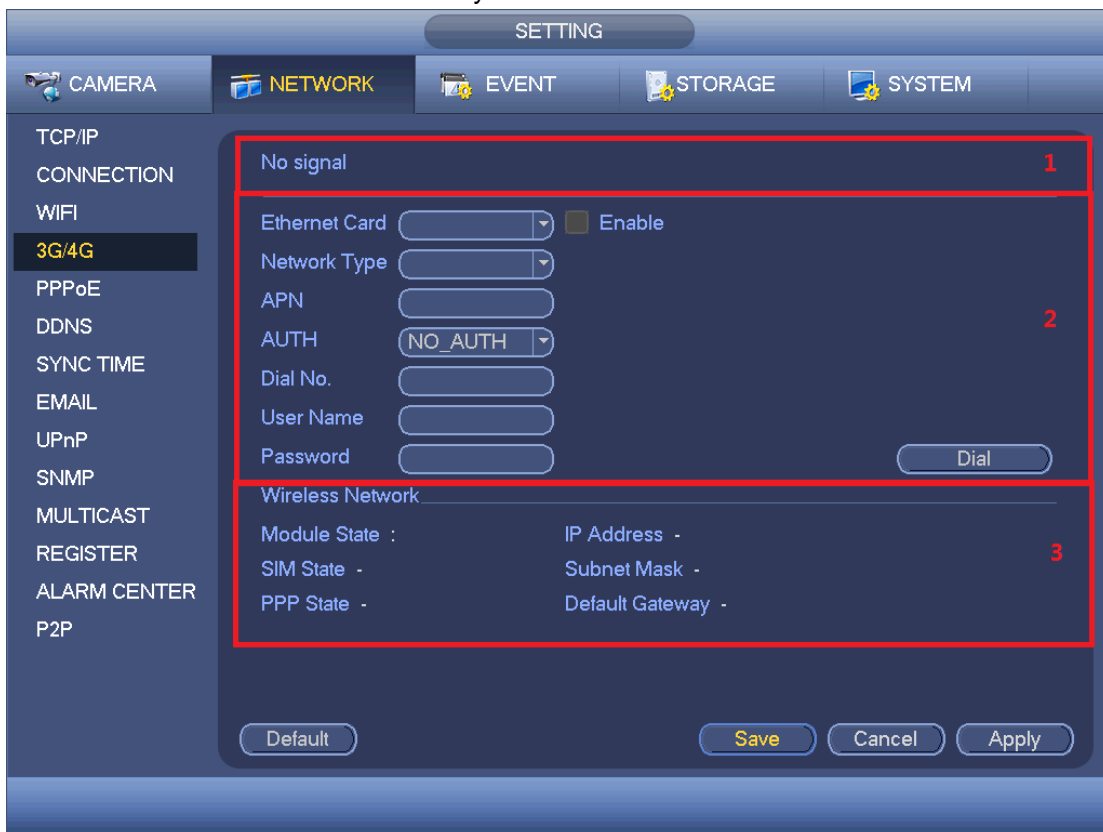

Figure 4-122

Step 3 Click Apply or Save to complete setup.

4.9.2.5 PPPoE



Note

This function is for some series products only.

Use PPPoE(Point-to-Point Protocol over Ethernet) to establish network connection. Device can get a dynamic IP address in the WAN. Before the operation, please contact your ISP (Internet service provider) for PPPoE user name and password.

Step 1 From main menu->Setting->Network->PPPoE.

Enter PPPoE interface. See Figure 4-123.

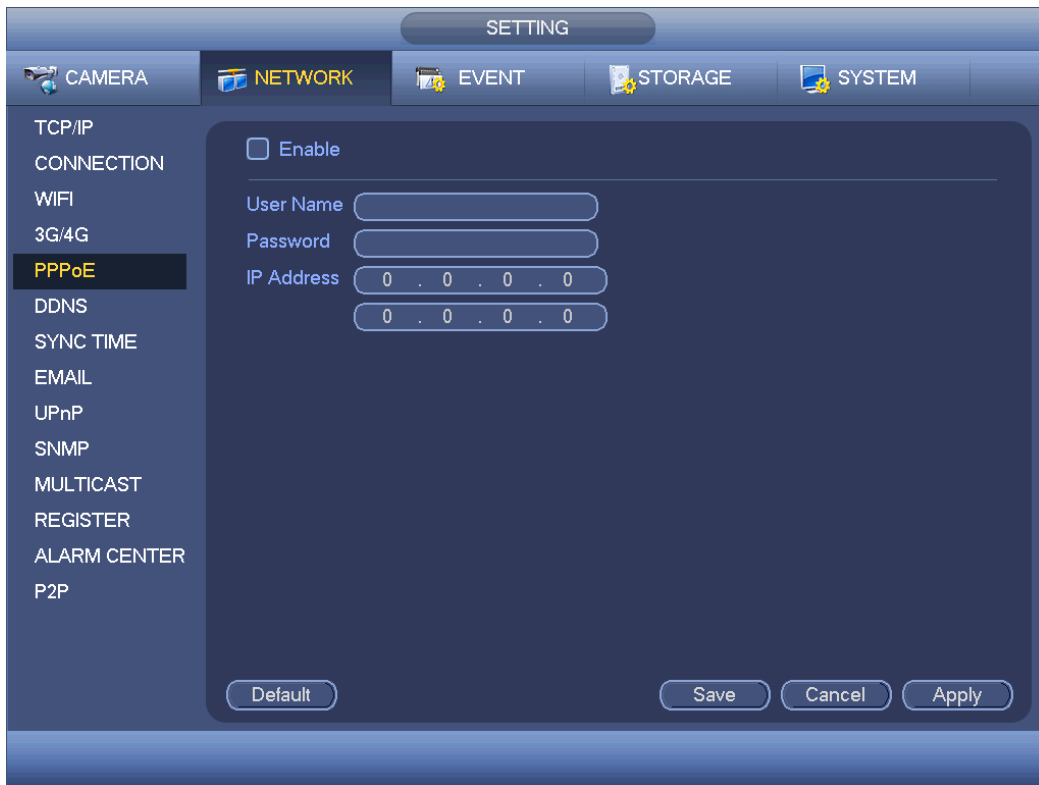

Figure 4-123

Step 2 Check the box to enable this function. Input PPPoE name and PPPoE password.

Step 3 Click Apply or Save to complete setup.

DVR needs to reboot to activate new setup. After rebooting, DVR will connect to internet automatically. The IP in the PPPoE is the DVR dynamic value. You can access this IP to visit the device.



Note

After enable PPPoE function, the IP address in the main menu->Setting->Network->TCP/IP is read-only.

4.9.2.6 DDNS

DDNS (Dynamic Domain Name Server) is to dynamically refresh the DNS domain name and IP address if the device IP address has changed frequently. The user can use the domain to access the device.

Note

The server from the third-party may collect your device information after you enable DDNS function.

Preparation

Before the operation, make sure the device supports DNS type and go to the DDNS service provider website to register the domain name via the PC.

Note

After you successfully registered and logged in the DDNS website, you can view all connected device information of current login user.

DDNS setup interface is shown as in Figure 4-124.

- Type/address:
 - ✧ DynDNS DDNS is members.dyndns.org.
 - ✧ NO-IP DDNS is dynupdate.no-ip.com.
 - ✧ CN99 DDNS is members.3322.org.
- Domain: The domain name registered on the DDNS service provider website.
- User name/password: Input the user name and password got from the DDNS service provider. Make sure you have logged in the DDNS service provider website to register an account (user name and password).
- Interval: After DDNS boots up, it sends out refresh query regularly. The unit is minute. Click Apply or Save to complete setup. Open a browser and input domain name, click Enter button.

The setting is right if you can view device WEB interface. Otherwise, please check the parameters.



Figure 4-124

4.9.2.7 Sync Time

This function allows specified IP host to change device time in case several hosts are syncing time with the device.

- Step 1 From main menu->Setting->Network->Sync time.
Enter Sync time interface. See Figure 4-125.
- Step 2 Check the box to enable Sync time function.
- Step 3 Refer to chapter 4.9.5.10 Security for setup information.

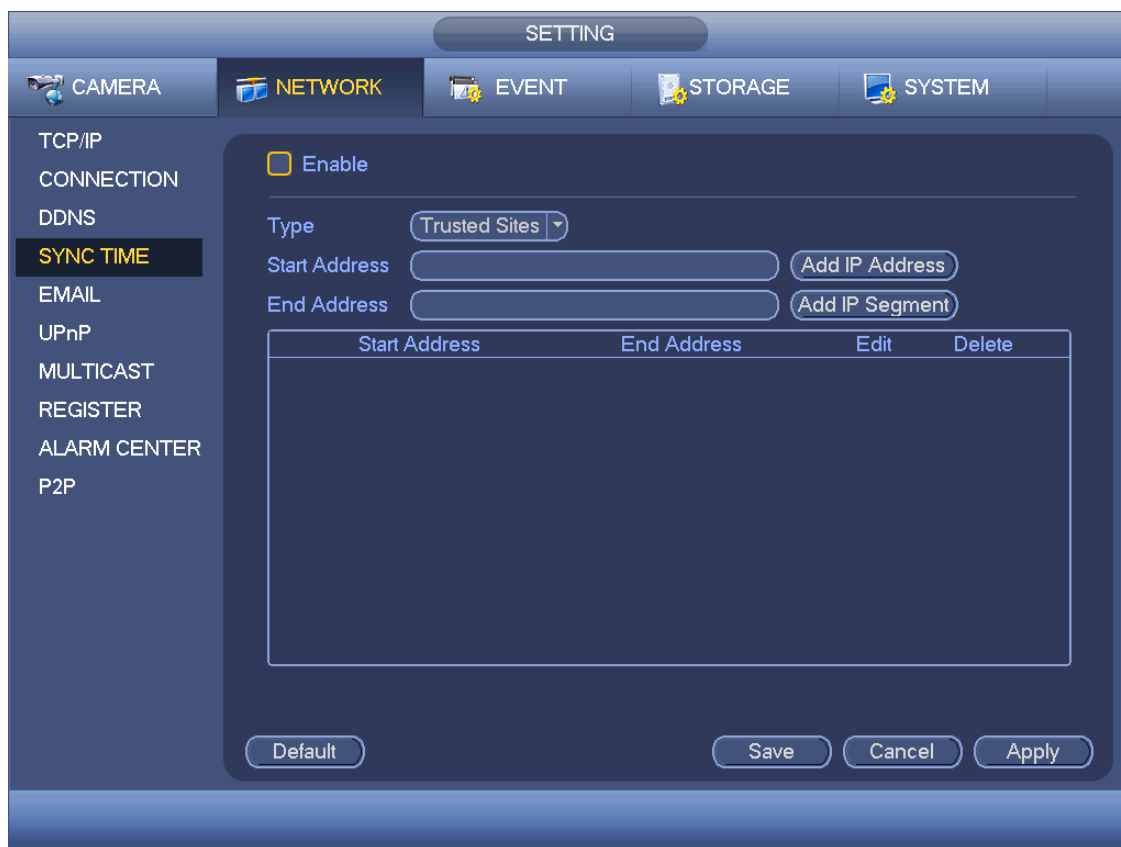

Figure 4-125

Step 4 Click Apply or Save to complete setup.



Note

If the DVR has enabled NTP service, the device will sync time with the NTP server regularly. The sync or change time operation of the IP address in the whitelist will be invalid, unless the NTP server and the IP address in the whitelist is the same.

4.9.2.8 Email

The email interface is shown as below. See Figure 4-126.

- SMTP server: Please input your email SMTP server IP here.
- Port: Please input corresponding port value here.
- User name: Please input the user name to login the sender email box.
- Password: Please input the corresponding password here.
- Sender: Please input sender email box here.
- Title: Please input email subject here. System support English character and Arabic number. Max 32-digit.
- Receiver: Please input receiver email address here. System max supports 3 email boxes. System automatically filters same addresses if you input one receiver repeatedly.
- Encryption type: The encryption type includes NONE, SSL and TLS.



Note

SMTP adopts TLS encryption mode by default.

- Interval: The send interval ranges from 0 to 3600 seconds. 0 means there is no interval.
- Health email enable: Please check the box here to enable this function. This function allows the system to send out the test email to check the connection is OK or not.
- Interval: Please check the above box to enable this function and then set the corresponding interval. System can send out the email regularly as you set here. Click the Test button, you can see the corresponding dialogue box to see the email connection is OK or not.

Please note system will not send out the email immediately when the alarm occurs. When the alarm, motion detection or the abnormality event activates the email, system sends out the email according to the interval you specified here. This function is very useful when there are too many emails activated by the abnormality events, which may result in heavy load for the email server.

The screenshot shows a web-based settings interface for a device. At the top, there is a 'SETTING' header and a navigation bar with tabs for CAMERA, NETWORK, EVENT, STORAGE, and SYSTEM. The NETWORK tab is selected. On the left side, there is a vertical menu with options: TCP/IP, CONNECTION, DDNS, SYNC TIME, EMAIL (highlighted), UPnP, MULTICAST, REGISTER, ALARM CENTER, and P2P. The main content area displays the SMTP configuration settings. At the top of this area is an 'Enable' checkbox, which is currently unchecked. Below this are several input fields: 'SMTP Server' (set to 'MailServer'), 'Port' (set to '25'), 'Anonymous' (checkbox), 'User Name' (text field), and 'Password' (text field). Further down are 'Receiver' and 'Sender' text fields. The 'Subject' field is set to 'ALERT' and has an 'Attachment' checkbox checked. The 'Encrypt Type' is a dropdown menu set to 'NONE'. There are two 'Interval' fields: one for seconds (set to '120') and one for minutes (set to '60'). At the bottom of the configuration area, there are three buttons: 'Default', 'Test', and 'Save'. At the very bottom of the interface, there are three more buttons: 'Save', 'Cancel', and 'Apply'.

Figure 4-126

4.9.2.9 UPnP

The UPnP protocol is to establish a mapping relationship between the LAN and the WAN. Please input the router IP address in the LAN in Figure 4-118. See Figure 4-127.

- UPnP on/off: Turn on or off the UPnP function of the device.
- Status: When the UPnP is offline, it shows as “Unknown”. When the UPnP works it shows “Success”
- Router LAN IP: It is the router IP in the LAN.
- WAN IP: It is the router IP in the WAN.

- Port Mapping list: The port mapping list here is the one to one relationship with the router's port mapping setting.
- List:
 - ✧ Service name: Defined by user.
 - ✧ Protocol: Protocol type
 - ✧ Internal port: Port that has been mapped in the router.
 - ✧ External port: Port that has been mapped locally.
- Default: UPnP default port setting is the HTTP, TCP and UDP of the DVR.

Double click one item; you can change the corresponding mapping information. See Figure 4-128.

Important:

When you are setting the router external port, please use 1024~5000 port. Do not use well-known port 1~255 and the system port 256~1023 to avoid conflict.

For the TCP and UDP, please make sure the internal port and external port are the same to guarantee the proper data transmission.



Figure 4-127

PORT INFO

Service Name TCP

Protocol TCP

Int.Port 37777

Ext.Port 37777

OK Cancel

Figure 4-128

4.9.2.10 SNMP

 **Note**

This function is for some series products only.

SNMP is an abbreviation of Simple Network Management Protocol. It provides the basic network management frame of the network management system. The SNMP widely used in many environments. It is used in many network device, software and system.

Preparation

- Install corresponding software tool such as MIB Builder and MG-SOFT MIB Browser.
- Contact technical engineer to get two MIB files of the current version.

Step 1 From main menu->Setting->Network->SNMP.

Enter SNMP interface. See Figure 4-129.



Figure 4-129

Step 2 Set parameters.

- Enable: Check the box to enable SNMP function.
- Version: Check the box and then select version. DVR can process the corresponding version information.

 **Note**

System adopts V3 by default. V1 or V2 may not be safe.

- SNMP port: The agent applications listening port on the DVR.
- Read/write community: The read/write community string the agent applications supports.
- Trap address: The Trap information destination address of the agent applications on the DVR.
- Trap port: The Trap information destination port of the agent applications on the DVR.
- Read-only user: It is to set read-only user to access the device.
- Read-write user: It is to set read-write user to access the device.
- Authentication type: It includes MD5 and SHA. System automatically recognizes the mode.
- Authentication password/encryption password: It is to set authentication password and encryption password. The password shall be at least 8-digit.
- Encryption type: It is to set encryption mode. The default mode is CBC-DES.

Step 3 In Figure 5-89, check the box to enable the SNMP function. Input the IP address of the PC than is running the software in the Trap address. You can use default

setup for the rest items.

- Step 4 Compile the above mentioned two MIB file via the software MIB Builder.
- Step 5 Run MG-SOFT MIB Browser to load the file from the previous step to the software.
- Step 6 Input the device IP you want to manage in the MG-SOFT MIB Browser. Please set the corresponding version for your future reference.
- Step 7 Open the tree list on the MG-SOFT MIB Browser; you can get the device configuration. Here you can see the device has how many video channels, audio channels, application version and etc.

4.9.2.11 Multicast

When you are accessing the device and view the video, the error occurs if the connected device amount has reached the threshold. In this situation, please set multicast IP to use multicast protocol to access.

Multicast setup interface is shown as in Figure 4-130.



Figure 4-130

Here you can set a multiple cast group. Please refer to the following sheet for detailed information.

- IP multiple cast group address
-224.0.0.0-239.255.255.255
-“D” address space
 - The higher four-bit of the first byte=“1110”
- Reserved local multiple cast group address

-224.0.0.0-224.0.0.255

-TTL=1 When sending out telegraph

-For example

224.0.0.1 All systems in the sub-net

224.0.0.2 All routers in the sub-net

224.0.0.4 DVMRP router

224.0.0.5 OSPF router

224.0.0.13 PIMv2 router

- Administrative scoped addressees

-239.0.0.0-239.255.255.255

-Private address space

- Like the single broadcast address of RFC1918
- Cannot be used in Internet transmission
- Used for multiple cast broadcast in limited space.

Except the above mentioned addresses of special meaning, you can use other addresses.

For example:

Multiple cast IP: 235.8.8.36

Multiple cast PORT: 3666.

After you logged in the Web, the Web can automatically get multiple cast address and add it to the multiple cast groups. You can enable real-time monitor function to view the view.

Please note multiple cast function applies to special series only.

4.9.2.12 Auto register

This function allows the device to auto register to the proxy you specified. In this way, you can use the client-end to access the DVR and etc via the proxy. Here the proxy has a switch function. In the network service, device supports the server address of IPv4 or domain.

Please follow the steps listed below to use this function.

Please set proxy server address, port, and sub-device name at the device-end. Please enable the auto register function, the device can auto register to the proxy server.

1) The setup interface is shown as in Figure 4-131.

Important

Do not input network default port such as TCP port number.



Figure 4-131

2) The proxy server software developed from the SDK. Please open the software and input the global setup. Please make sure the auto connection port here is the same as the port you set in the previous step.

3) Now you can add device. Please do not input default port number such as the TCP port in the mapping port number. The device ID here shall be the same with the ID you input in Figure 4-131. Click Add button to complete the setup.

4) Now you can boot up the proxy server. When you see the network status is Y, it means your registration is OK. You can view the proxy server when the device is online.

Important

The server IP address can also be domain. But you need to register a domain name before you run proxy device server.

4.9.2.13 Alarm Centre

This interface is reserved for you to develop. See Figure 4-132.

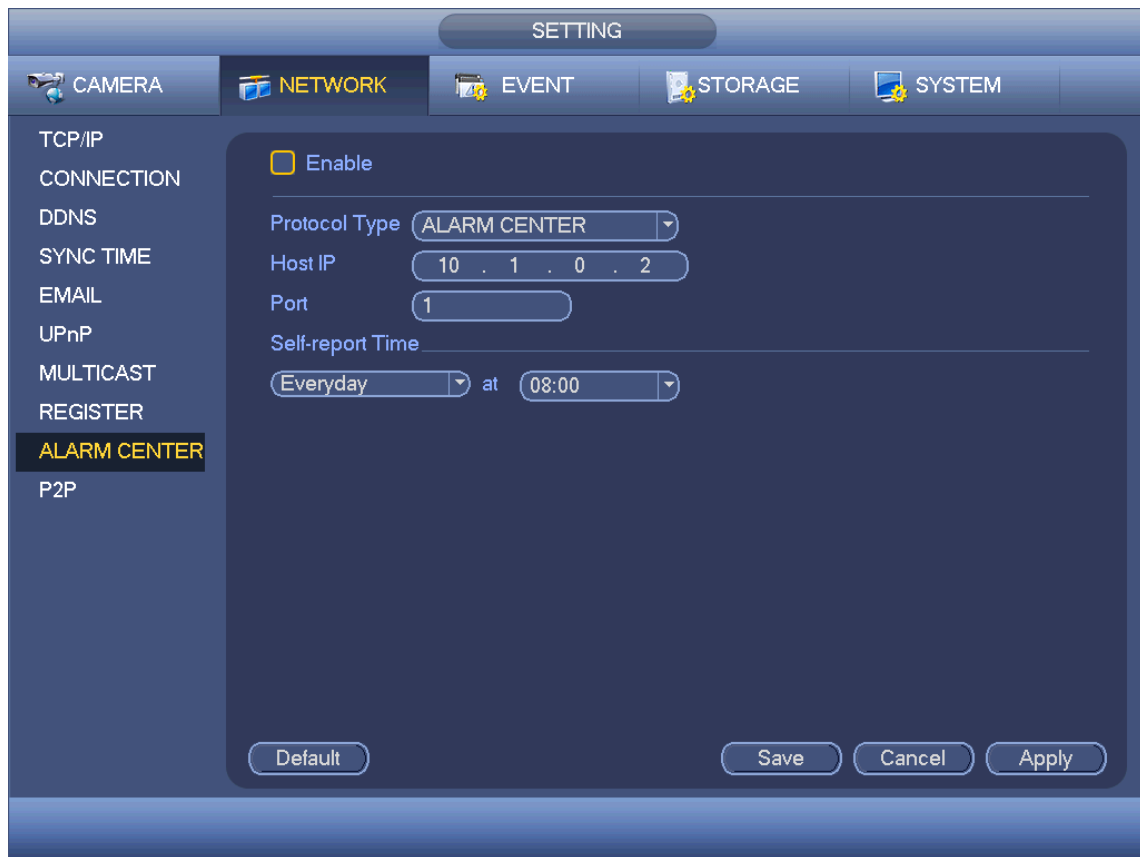

Figure 4-132

4.9.2.14 P2P

Refer to chapter 4.1.4.3 P2P for detailed information.

4.9.3 Event

4.9.3.1 Detect

In the main menu, from Setting->Event->Detect, you can see motion detect interface. See Figure 4-133. There are four detection types: motion detection, video loss, tampering and diagnosis.

- The video loss has no detection region and sensitivity setup and tampering has no detection region setup.
- You can see motion detect icon if current channel has enabled motion detect alarm.
- You can drag you mouse to set motion detect region. Please click OK button to save current region setup. Right click mouse to exit current interface.
- For digital channel, the detect function refers to support detection function of the front-end and support local activation function. The front-end can get enable/disable status, sensitivity and region setup. You can get corresponding prompt if front-end cannot get the above information. You can change front-end setup if it can get.

4.9.3.1.1 Motion Detect

After analysis video, system can generate a video loss alarm when the detected moving signal reached the sensitivity you set here.

Detection menu is shown as below. See Figure 4-133.



- Channel: Select a channel from the dropdown list to set motion detect function.
- Enable MD: Check the box here to enable motion detect function.
- Enable PIR: PIR function help enhance the motion detect accuracy and validity. It is to filter the false alarm triggered by leaves, small fly and insects. The PIR detection zone is smaller than the camera angle of view. The PIR function is enabled by default if the connected remote device supports the PIR function. When the PIR function is on, motion detection function is on by default. The motion detect event occurs when these two function are enabled at the same time. If the PIR function is disabled, check the enable box to enable the general motion detect function.



Note

- ◇ The channel type shall be CVI if you want to enable PIR function.
- ◇ If the remote device does not support PIR function, the PIR item on the interface is grey or is hiding. That is to say, the PIR function is null.
- ◇ The interface does not display PIR enable state if current DVR does not support PIR function.
- Region: Click select button, the interface is shown as in Figure 4-134. Here you can set motion detection zone. There are four zones for you to set. Please select a zone first and then left drag the mouse to select a zone. The corresponding color zone displays different detection zone. You can click Fn button to switch between the arm mode and disarm mode. In arm mode, you can click the direction buttons to move the green rectangle to set the motion detection zone. After you completed the setup, please click ENTER button to exit current setup. Do remember click save button to save current setup. If you click ESC button to exit the region setup interface system will not save your zone setup.
- Sensitivity: System supports 6 levels. The sixth level has the highest sensitivity.
- Anti-dither: Here you can set anti-dither time. The value ranges from 5 to 600s. The anti-dither time refers to the alarm signal lasts time. It can be seem as the alarm signal activation stays such as the buzzer, tour, PTZ activation, snapshot, channel record. The stay time here does not include the latch time. During the alarm process, the alarm signal can begin an anti-dither time if system detects the local alarm again. The screen prompt, alarm upload, email and etc will not be activated. For example, if you set the anti-dither time as 10 second, you can see the each activation may last 10s if the local alarm is activated. During the process, if system detects another local alarm signal at the fifth second, the buzzer, tour, PTZ activation, snapshot, record channel will begin another 10s while the screen prompt, alarm upload, email will not be activated again. After 10s, if system detects another alarm signal, it can generate an alarm since the anti-dither time is out.
- Period: Click set button, you can see an interface is shown as in Figure 4-136. Here you can set motion detect period. System only enables motion detect operation in the

specified periods. It is not for video loss or the tampering. There are two ways for you to set periods. Please note system only supports 6 periods in one day.

- ✧ In Figure 4-136, Select icon  of several dates, all checked items can be edited together. Now the icon is shown as . Click  to delete a record type from one period.

- ✧ In Figure 4-136. Click button  after one date or a holiday, you can see an interface shown as in Figure 4-137. There are four record types: regular, motion detection (MD), Alarm, MD & alarm.
 - Alarm output: when an alarm occurs, system enables peripheral alarm devices.
 - Latch: when motion detection complete, system auto delays detecting for a specified time. The value ranges from 1-300(Unit: second)
 - Show message: System can pop up a message to alarm you in the local host screen if you enabled this function.
 - Alarm upload: System can upload the alarm signal to the network (including alarm center) if you enabled current function.
 - Send email: System can send out email to alert you when an alarm occurs.
 - Record channel: System auto activates motion detection channel(s) to record once an alarm occurs. Please make sure you have set MD record in Schedule interface(Main Menu->Setting->Schedule) and schedule record in manual record interface(Main Menu->Advanced->Manual Record)
 - PTZ activation: Here you can set PTZ movement when an alarm occurs. Such as go to preset, tour & pattern when there is an alarm. Click “select” button, you can see an interface is shown as in Figure 4-135.
 - Record Delay: System can delay the record for specified time after alarm ended. The value ranges from 10s to 300s.
 - Tour: Here you can enable tour function when an alarm occurs. System one-window tour.
 - Snapshot: You can enable this function to snapshot image when a motion detect alarm occurs.
 - Video matrix Check the box here to enable this function. When an alarm occurs, SPOT OUT port displays device video output. It displays video (1-window tour) from alarm activation channel you select at the Record channel item.
 - Buzzer: Highlight the icon to enable this function. The buzzer beeps when an alarm occurs.
 - Log: Check the box here, system can record motion detect log.
 - Test: Click it to test current motion detect setup (do not need to save). Click Select button after Region, you can set motion detect area.
 - Voice prompts: Check the box here to trigger audio broadcast function. You can select specified audio file here. System can play the audio file once the corresponding event occurs.

Please highlight icon  to select the corresponding function. After all the setups please click save button. .

 **Note**

In motion detection mode, you cannot use copy/paste to set channel setup since the video in each channel may not be the same.

In Figure 4-134, you can left click mouse and then drag it to set a region for motion detection. Click Fn to switch between arm/withdraw motion detection. After setting, click enter button to exit.



Figure 4-133

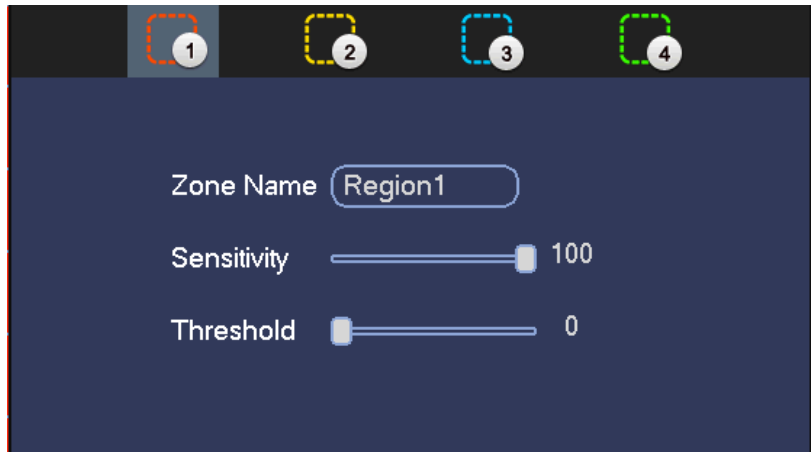

Figure 4-134



Figure 4-135

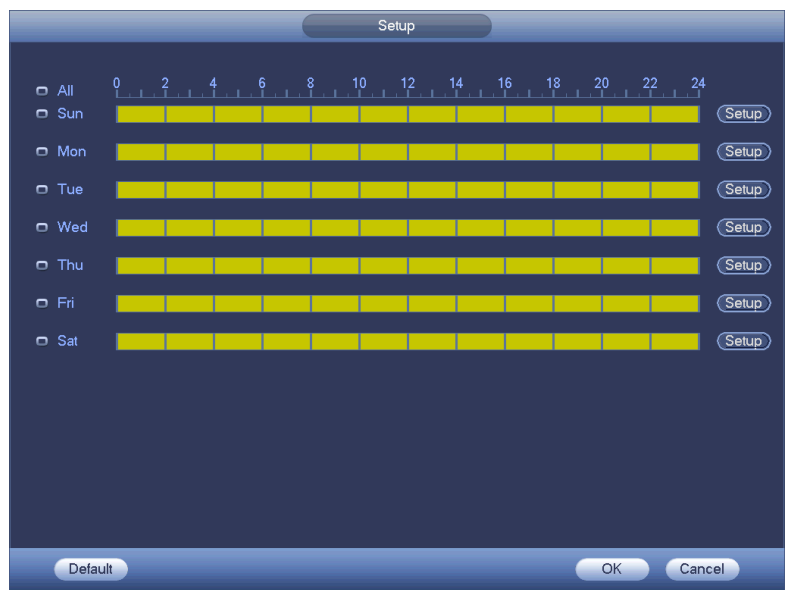

Figure 4-136



Figure 4-137

Motion detect here only has relationship with the sensitivity and region setup. It has no relationship with other setups.

4.9.3.1.2 Video Loss

In Figure 4-133, select video loss from the type list. You can see the interface is shown as in Figure 4-138. This function allows you to be informed when video loss phenomenon occurred. You can enable alarm output channel and then enable show message function.

Note

You can enable preset/tour/pattern activation operation when video loss occurs. Please refer to chapter 4.9.3.1.1 motion detection for detailed information.

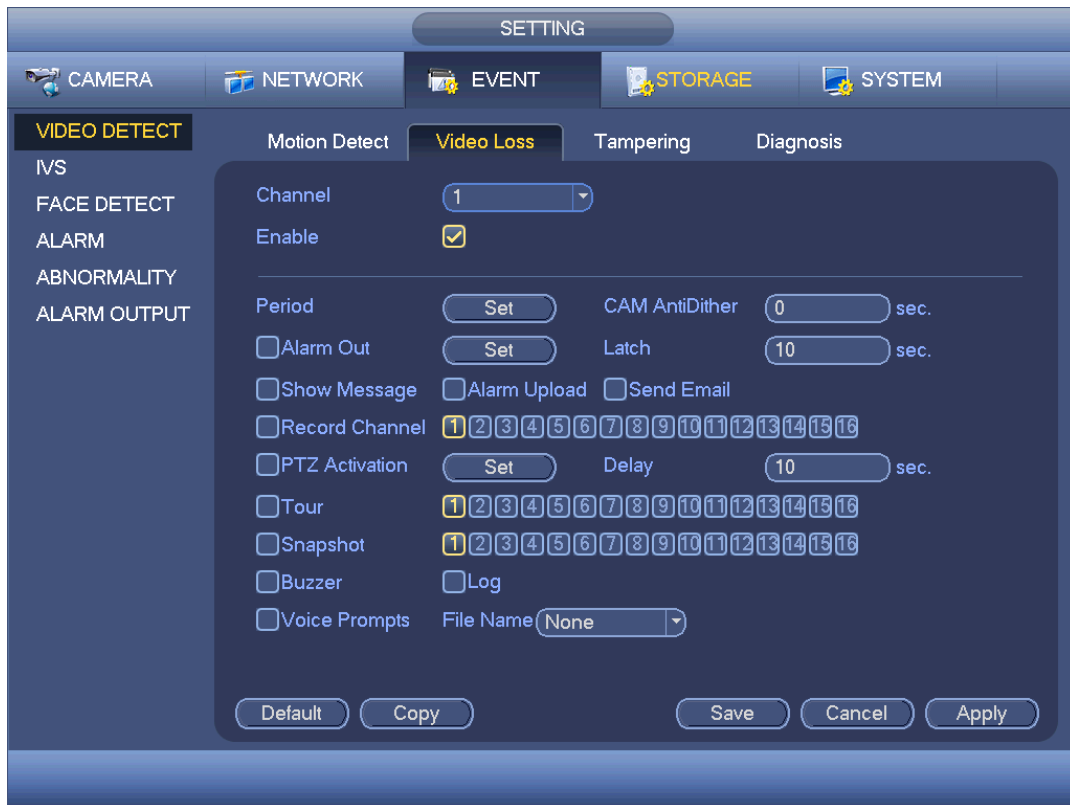

Figure 4-138

4.9.3.1.3 Tampering

When someone viciously masks the lens, or the output video is in one-color due to the environments light change, the system can alert you to guarantee video continuity. Tampering interface is shown as in Figure 4-139. You can enable “Alarm output” or “Show message” function when tampering alarm occurs.

- Sensitivity: The value ranges from 1 to 6. It mainly concerns the brightness. The level 6 has the higher sensitivity than level 1. The default setup is 3.

Tips:

You can enable preset/tour/pattern activation operation when video loss occurs. Please refer to chapter 4.9.3.1.1 motion detection for detailed information.



Note

- In Detect interface, copy/paste function is only valid for the same type, which means you cannot copy a channel setup in video loss mode to tampering mode.
- About Default function. Since detection channel and detection type may not be the same, system can only restore default setup of current detect type. For example, if you click Default button at the tampering interface, you can only restore default tampering setup. It is null for other detect types.
- System only enables tampering function during the period you set here. It is null for motion detect or video loss type.

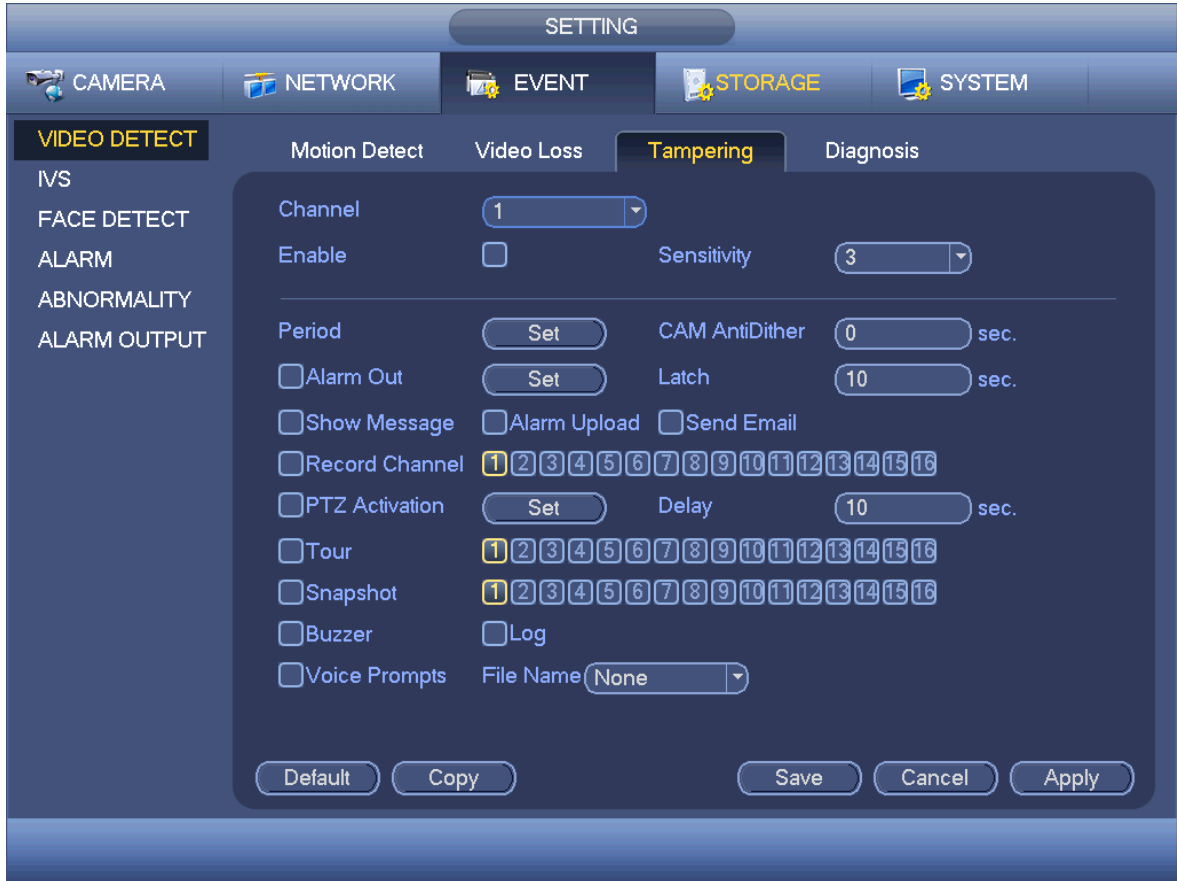

Figure 4-139

4.9.3.1.4 Diagnosis

 **Note**

This function is for some series only.

System can trigger an alarm when the stripe, noise, color cast, out of focus, over exposure event occurred. See Figure 4-140.

Please refer to chapter 4.9.3.1.1 motion detection for detailed information.



Figure 4-140

This function allows you to be informed when video is blurry, over exposure or color cast occurs. You can enable alarm output channel and then enable show message function. Click the Rule Set button, or move the cursor to Set button and then click the Enter button on the front panel, the interface is shown as below. See Figure 4-141.

You can check corresponding type and then input alarm threshold.

- Stripe: The strip occurs when the device is old or there is electronic interference. There may be cross strip, vertical strip, slanting strip and etc.
- Noise: The video noise refers to the blurry video, poor video quality. It may result from the optical system distortion or the hardware problem during the video transmission when recording.
- Color cast: Usually the video is color containing RGB. When these three colors displayed in abnormal rate, we can say color cast occurred.
- Out of focus: The clear video presents abundant video details. The video definition decreases when the distortion event occurs. The out of focus event may result from many sources such as video transmission, processing and etc.
- Over exposure: The color brightness refers to the image pixel intensity. Black is the darkest and the white is the brightest. We use number 0 to stand for black and use number 255 to stand for white. Once the brightness threshold of the whole image has exceeded the threshold value, it means the image is over exposure.
- Threshold: The value ranges from 1 to 30. System can generate an alarm once the value is higher than the threshold you set here.

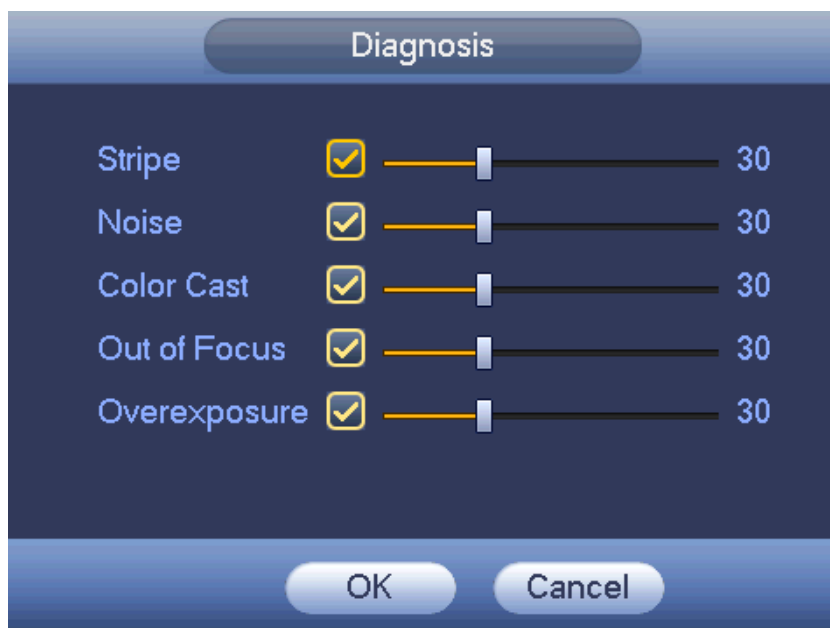

Figure 4-141

 **Note**

Video analysis alarm can trigger PTZ preset, tour, and pattern.
Please refer to chapter 4.9.3.1.1 motion detection for detailed information.

4.9.3.2 IVS (Optional)

 **CAUTION**

- The IVS function is optional.
- The different series products support different IVS functions. Please refer to your purchased product actual interface for detailed information.
- Disable Add IP channel function if you want to use IVS function.

Once any object violates the rule, the DVR can trigger an alarm and alert you as the specified alarm mode.

Step 1 From main menu->Setting->Event->IVS.
Enter IVS interface. See Figure 4-142.

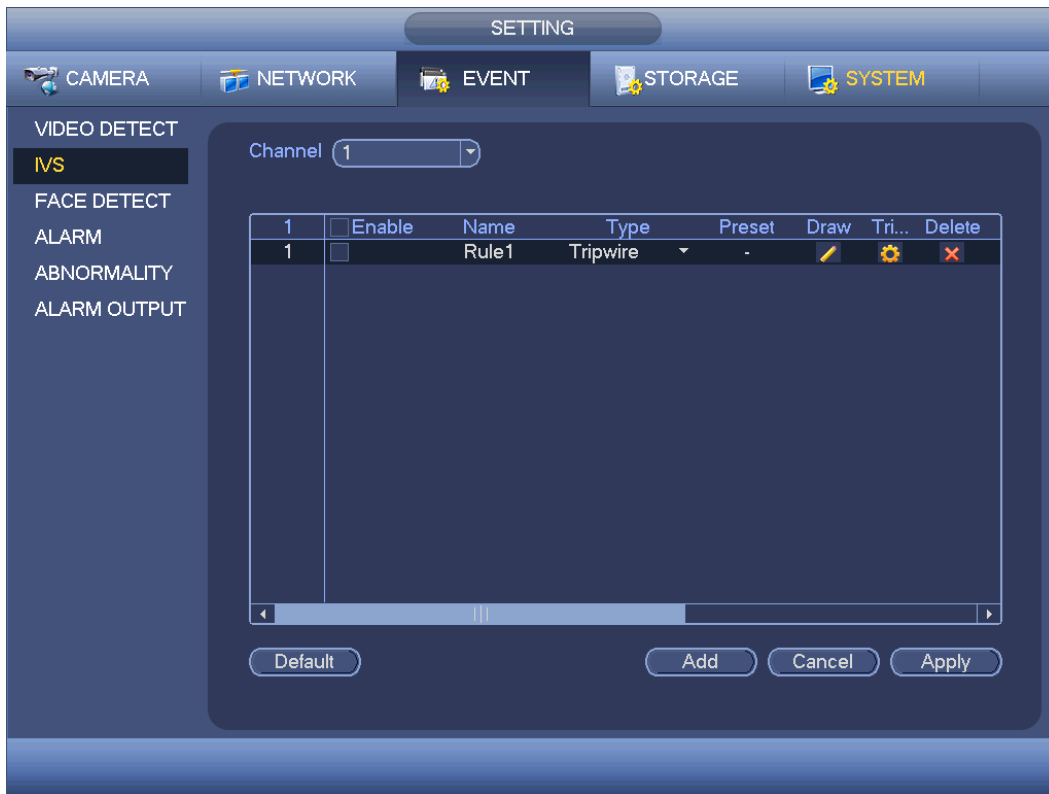

Figure 4-142

- Step 2 Select a channel from the dropdown list.
- Step 3 Click Add button to add a rule and then select a rule type from the dropdown list.
- Step 4 Set corresponding parameters.
- Step 5 Check the box to enable current rule.
- Step 6 Click Apply or Save to complete setup.

4.9.3.3 Tripwire (Optional)

System generates an alarm once there is any object crossing the tripwire in the specified direction.

- The tripwire supports customized setup. It can be a straight line or a curve.
- Support one-direction or dual-direction detection.
- Support several tripwires at the same scene suitable for complicated environment.
- Support object size filter.

Step 1 From main menu->Setting->Event->IVS, click Add button to add a rule and select the rule type as tripwire.

The interface is shown as below. See Figure 4-143.

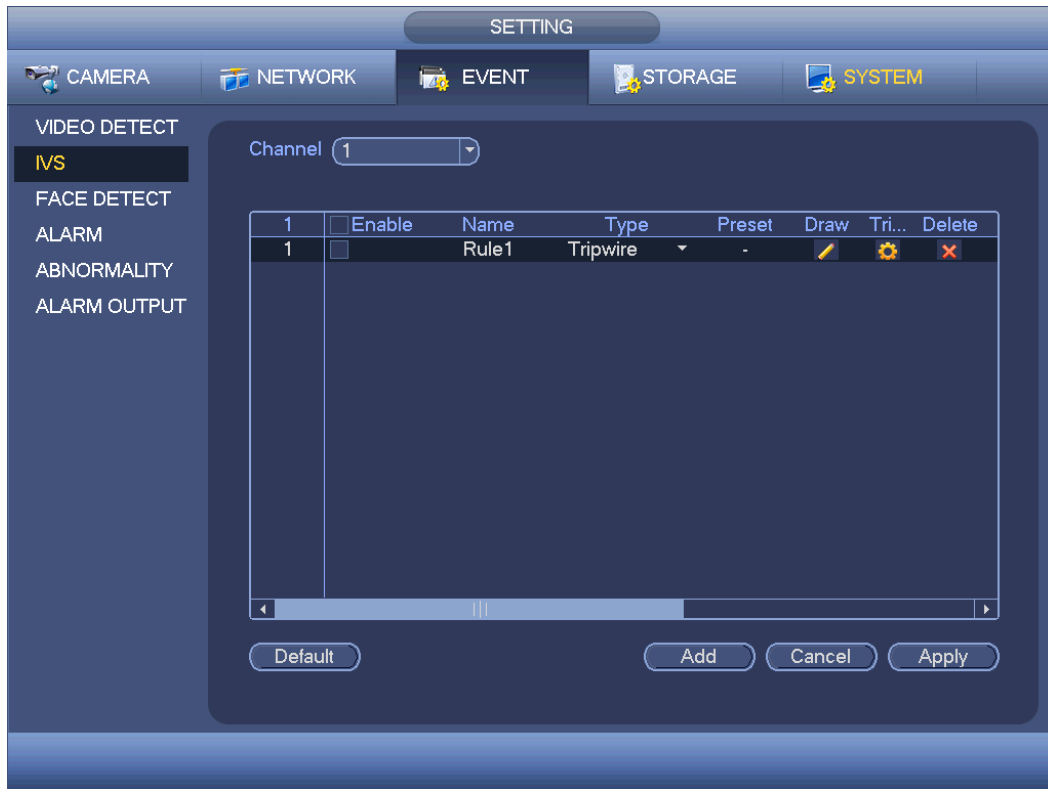

Figure 4-143

Step 2 Draw tripwire.

1. Click Draw button to draw the tripwire. See Figure 4-144.

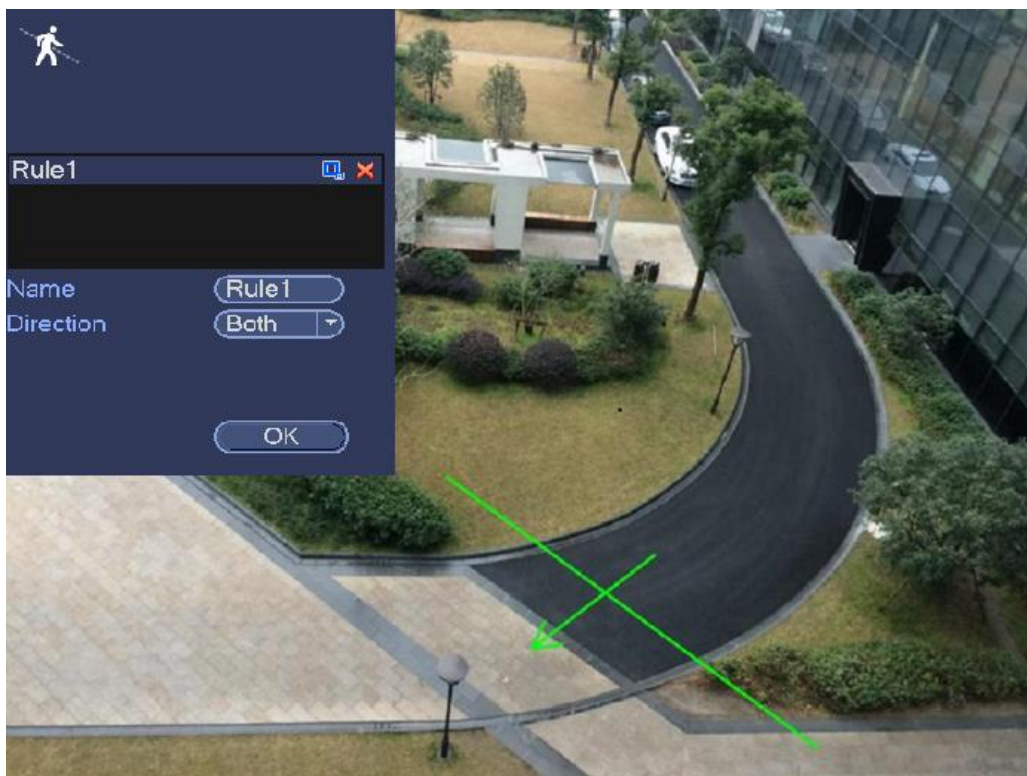







Figure 4-144

2. Select direction, and then input customized rule name.
 - Name: Input customized rule name.
 - Direction (L→R/R→L/Both): System can generate an alarm once there is any object crossing in the specified direction.
 - Target filter: Click , you can set filter object size. Each rule can set two sizes (min size/max size). Once the object is smaller than the min size or larger than the max size, there is no alarm. Please make sure the max size is larger than the min size.
3. Left click mouse to draw a tripwire. The tripwire can be a direct line, curve or polygon. Right click mouse to complete.
4. Click OK.
Complete drawing tripwire.

Step 3 Click  to set parameters.

Enter triggered parameters interface. See Figure 4-145.

Step 4 Set parameters.

- Period: Click set button, you can see an interface is shown as in Figure 4-136. Here you can set tripwire period. System only enables tripwire operation in the specified periods. There are two ways for you to set periods. Please note system only supports 6 periods in one day.
- ✧ In Figure 4-136, Select icon  of several dates, all checked items can be edited together. Now the icon is shown as . Click  to delete a record type from one period.
- ✧ In Figure 4-136. Click button  after one date or a holiday, you can see an interface shown as in Figure 4-137.
 - Alarm output: when an alarm occurs, system enables peripheral alarm devices.
 - Latch: when tripwire complete, system auto delays detecting for a specified time. The value ranges from 1-300(Unit: second)
 - Show message: System can pop up a message to alarm you in the local host screen if you enabled this function.
 - Send email: System can send out email to alert you when an alarm occurs.
 - Record channel: System auto activates tripwire channel(s) to record once an alarm occurs. Please make sure you have set intelligent record in Schedule interface(Main Menu->Setting->Schedule) and schedule record in manual record interface(Main Menu->Advanced->Manual Record)
 - PTZ activation: Here you can set PTZ movement when an alarm occurs. Such as go to preset, tour & pattern when there is an alarm. Click “set” button, you can see an interface is shown as in Figure 4-146.
 - Record Delay: System can delay the record for specified time after alarm ended. The value ranges from 10s to 300s.

- Tour: Here you can enable tour function when an alarm occurs. Please go to main menu->Setting->System->Display->Tour to set tour type and interval (chapter 4.9.5.2.3 Tour)
- Snapshot: You can enable this function to snapshot image when a motion detect alarm occurs.
- Video matrix: Check the box here to enable this function. When an alarm occurs, VIDEO OUTPUT port displays device video output. It displays video (1-window tour) from alarm activation channel you select at the Record channel interface. It has high priority than the tour setup in Main menu->Setting->System->Video matrix. Please note this function is for some series product only.
- Buzzer: Highlight the icon to enable this function. The buzzer beeps when an alarm occurs.
- Log: Check the box here, system can record corresponding alarm log.
- Voice prompts: Check the box here to trigger audio broadcast function. You can select specified audio file here. System can play the audio file once the corresponding event occurs.



Figure 4-145

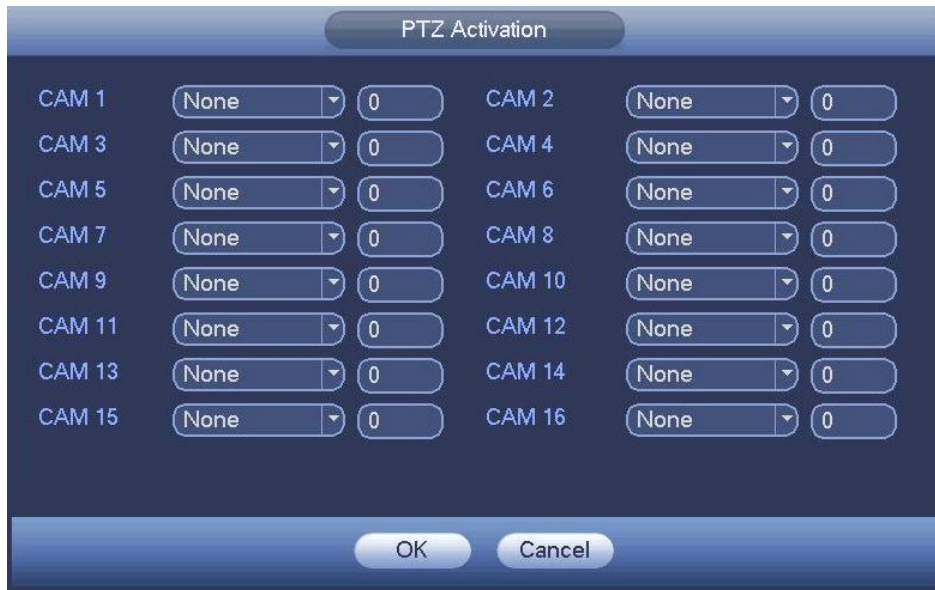

Figure 4-146

Step 5 Click OK button in Figure 4-145.

Device goes back to Figure 4-143.

Step 6 Check the Enable box to enable tripwire function. Click Apply or Save to complete setup.

Device begins tripwire detection.

4.9.3.4 Intrusion (Cross warning zone) (Optional)

System generates an alarm once there is any object entering or exiting the zone in the specified direction.

- System supports customized area shape and amount.
- Support appear/cross detection.
- Can detect the moving object operation in the specified zone, customized trigger amount and staying time.
- Support objects filter function.

Step 1 From main menu->Setting->Event->IVS, click Add button and then select type as intrusion, the interface is shown as below. See Figure 4-147.



Figure 4-147

Step 2 Draw the zone.

1. Click draw button  to draw the zone. See Figure 4-148.

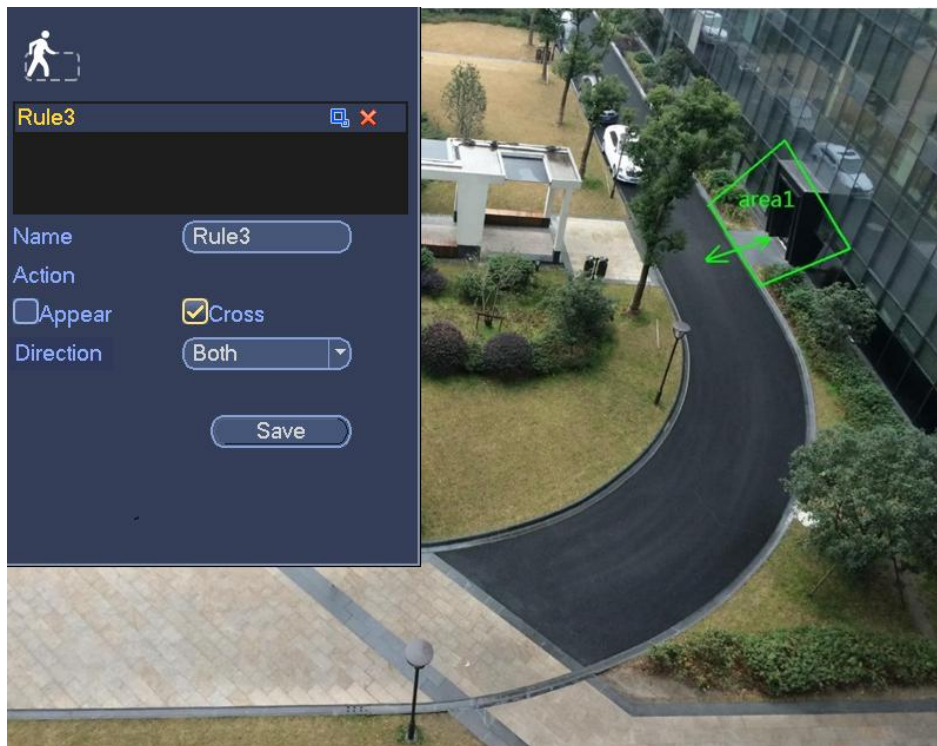



Figure 4-148

2. Select direction, and then input customized rule name.
 - Name: Input customized rule name.
 - Action: You can set intrusion action: appear/cross.
 - Direction (Entry/Exit/Both): System can generate an alarm once there is any object crossing in the specified direction.
 - Target filter: Click , you can set filter object size. Each rule can set two sizes (min size/max size). Once the object is smaller than the min size or larger than the max size, there is no alarm. Please make sure the max size is larger than the min size.
3. Left click mouse to draw a warning zone. Right click mouse to complete the setup.
4. Click OK.
Complete drawing intrusion rule.

Step 3 Click , it is to set parameters.

Please refer to chapter 4.9.3.3 to set other parameters.

Step 4 Check the Enable box to enable intrusion function. Click Apply or Save to complete setup.

Device begins intrusion detection.

4.9.3.5 Abandoned Object Detect (Optional)

System generates an alarm when there is abandoned object in the specified zone.

- System supports customized area shape and amount.
- Support duration setup.
- Support objects filter function.

Step 1 From main menu->Setting->Event->IVS, click Add button and then select the type as abandoned object. The object interface is shown as below. See Figure 4-149.



Figure 4-149

Step 2 Draw the zone.

1. Click draw button  to draw the zone. See Figure 4-150.

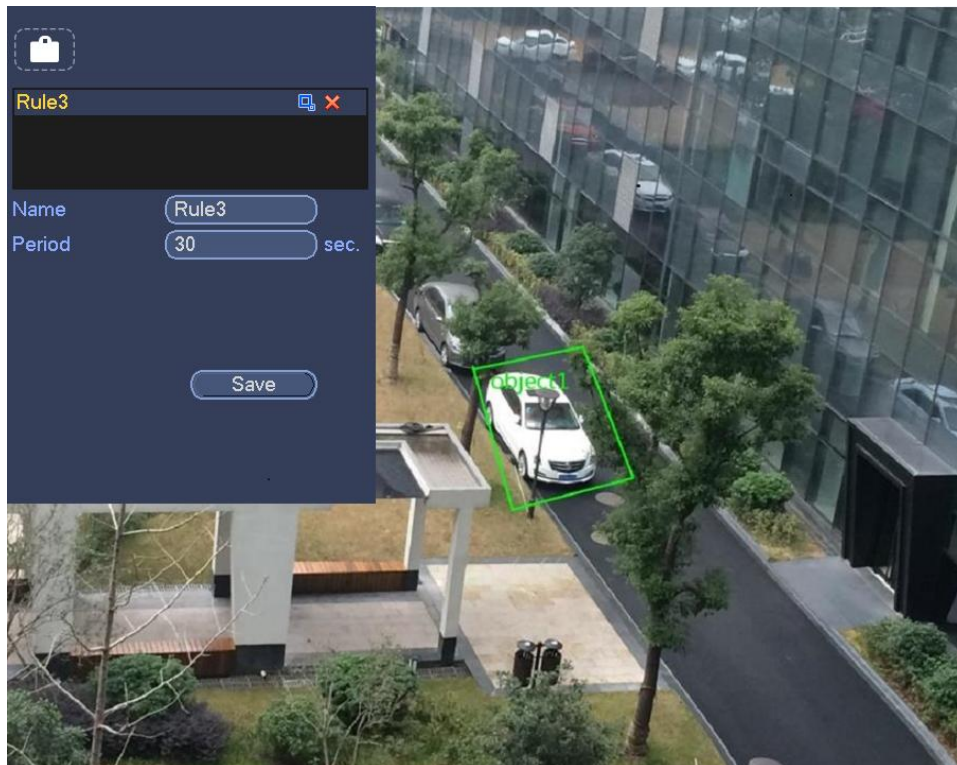



Figure 4-150

2. Set parameters.
 - Name: Input customized rule name.
 - Period: System can generate an alarm once the object is in the zone for the specified period.
 - Target filter: Click , you can set filter object size. Each rule can set two sizes (min size/max size). Once the object is smaller than the min size or larger than the max size, there is no alarm. Please make sure the max size is larger than the min size.
3. Left click mouse to draw a zone, until you draw a rectangle, you can right click mouse.
4. Click OK.
Complete drawing abandoned object detection rule.

Step 3 Click , it is to set parameters.

Please refer to chapter 4.9.3.3 to set other parameters.

Step 4 Check the Enable box to enable abandoned object detection function. Click Apply or Save to complete setup.
Device begins abandoned object detection.

4.9.3.6 Missing Object Detection (Optional)

System generates an alarm when there is missing object in the specified zone.

- System supports customized area shape and amount.
- Support duration setup.
- Support objects filter function.

Step 1 From main menu->Setting->Event->IVS, select the type as abandoned object, the object interface is shown as below. See Figure 4-151.



Figure 4-151

Step 2 Draw the zone.

1. Click Draw button  to draw a zone. See Figure 4-152.

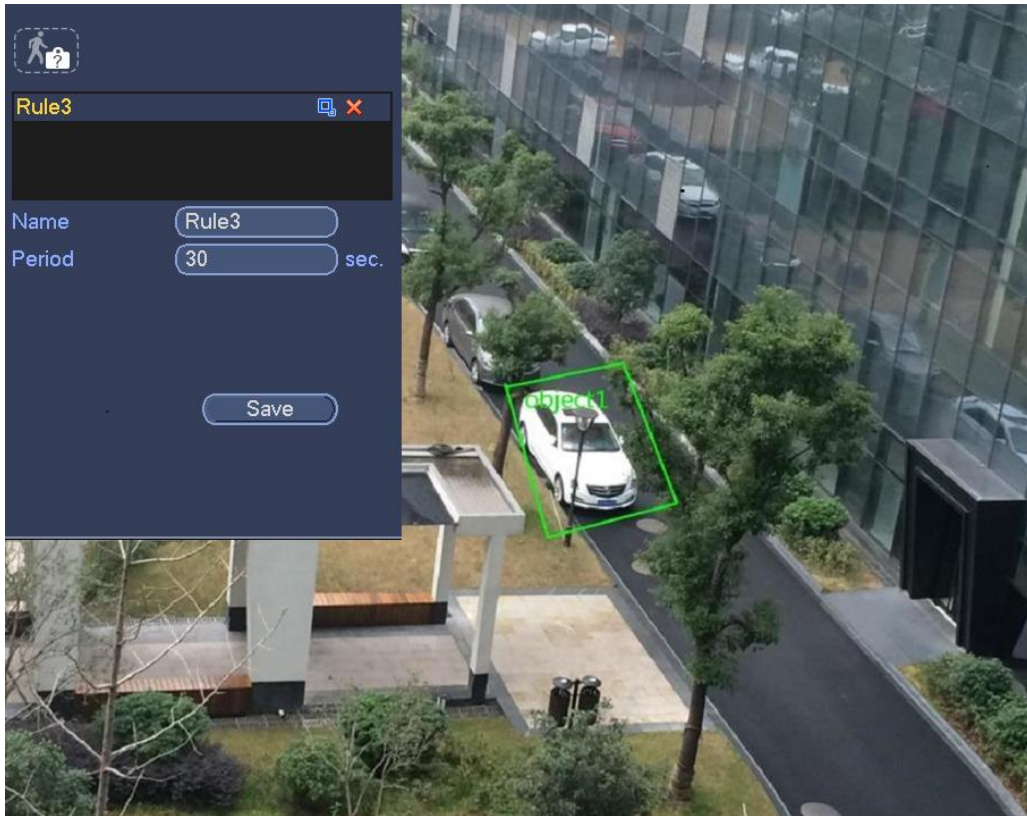



Figure 4-152

2. Set parameters.
 - Name: Input customized rule name.
 - Period: System can generate an alarm once the object in the zone is missing for the specified period.
 - Target filter: Click , you can set filter object size. Each rule can set two sizes (min size/max size). Once the object is smaller than the min size or larger than the max size, there is no alarm. Please make sure the max size is larger than the min size.
3. Left click mouse to draw a zone, until you draw a rectangle, you can right click mouse.
4. Click OK.
Complete drawing missing object detection rule.

Step 3 Click , it is to set parameters.

Please refer to chapter 4.9.3.3 motion detect to set other parameters.

Step 4 Check the Enable box to enable missing object detection function. Click Apply or Save to complete setup.
Device begins missing object detection.

4.9.3.7 Face Detect (Optional)



The face detection function is optional. The intelligence function and the human face detection cannot be valid at the same time!



Note

- The face detection function is valid once your network camera or your DVR supports this function.
- If your purchased DVR supports the face detection function, it supports one analog channel. It is not for the digital channel
- The intelligence function and the face detection function cannot be valid at the same time.

System can detect and filter the human face via analyzing the video. When it detects the human face in the specified zone, it can draw the rectangle around the human face and trigger record, snapshot, alarm operation and etc. See Figure 4-153.

- Channel: Select a channel you want to enable face detect function.
- Alarm face number: Once the detected human face number reaches the threshold you set here, system can generate an alarm.
- Enable: Check the box here to enable face detect function.

For detailed setup information, please refer to chapter Step 6.

The screenshot shows the 'SETTING' interface for 'EVENT' configuration. The 'FACE DETECT' section is active. It shows options for Channel (1), Enable (unchecked), Period (Set), Alarm Out (unchecked), Latch (10 sec), Send Email (unchecked), Record Channel (checked, 1-16), PTZ Activation (unchecked), Delay (10 sec), Snapshot (1-16), Buzzer (unchecked), Log (unchecked), Voice Prompts (unchecked), and File Name (None). Buttons for Default, Save, Cancel, and Apply are at the bottom.

Figure 4-153

4.9.3.8 Alarm

Note

XVR series product does not support HDCVI alarm function (Figure 4-156).

Before operation, please make sure you have properly connected alarm devices such as buzzer.

In the main menu, from Setting->Event->Alarm, you can see alarm setup interface.



For analog channel, the interface is shown as in Figure 4-154 and Figure 4-155

For HDCVI channel, there are three alarm types. See Figure 4-154 to Figure 4-156.

For digital channel, there are four alarm types. See Figure 4-154 to Figure 4-158.

- Local alarm: The alarm signal system detects from the alarm input port.
- HDCVI: System can get the camera temperature, smoke, external alarm and set corresponding alarm activation operation.
- IPC external alarm: It is the on-off alarm signal from the front-end device and can activate the local HDVR.
- IPC offline alarm: Once you select this item, system can generate an alarm when the front-end IPC disconnects with the local HDVR. The alarm can activate record, PTZ, snap and etc. The alarm can last until the IPC and the HDVR connection resumes.
- Alarm box: The alarm signal from the connected peripheral alarm box.

Important

- **If it is your first time to boot up the device, the disconnection status of the front-end network camera will not be regarded as offline. After one successfully connection, all the disconnection events will be regarded as IPC offline event.**
- **When IPC offline alarm occurs, the record and snapshot function of digital channel is null.**
- Alarm in: Here is for you to select channel number.
- Type: normal open or normal close.
- PTZ activation: Here you can set PTZ movement when an alarm occurs. Such as go to preset, tour& pattern when there is an alarm. Click “select” button, you can see an interface is shown as in Figure 4-159.
- Period: Click set button, you can see an interface is shown as in Figure 4-160. There are max 6 periods in one day. There are two ways for you to set periods.
 - ◇ In Figure 4-160, Select icon  of several dates, all checked items can be edited together. Now the icon is shown as .
 - ◇ In Figure 4-160. Click Setup button after one date or a holiday, you can see an interface shown as in Figure 4-161. .
- Anti-dither: Here you can set anti-dither time. Here you can set anti-dither time. The value ranges from 5 to 600s. The anti-dither time refers to the alarm signal lasts time. It can be seem as the alarm signal activation stays such as the buzzer, tour, PTZ activation, snapshot, channel record. The stay time here does not include the latch time. During the alarm process, the alarm signal can begin an anti-dither time if system detects the local alarm again. The screen prompt, alarm upload, email and etc

will not be activated. For example, if you set the anti-dither time as 10 second, you can see the each activation may last 10s if the local alarm is activated. During the process, if system detects another local alarm signal at the fifth second, the buzzer, tour, PTZ activation, snapshot, record channel will begin another 10s while the screen prompt, alarm upload, email will not be activated again. After 10s, if system detects another alarm signal, it can generate an alarm since the anti-dither time is out.

- Show message: System can pop up a message to alarm you in the local host screen if you enabled this function.
- Alarm upload: System can upload the alarm signal to the network (including alarm center) if you enabled current function.
- Send email: System can send out email to alert you when an alarm occurs.
- Record channel: you can select proper channel to record alarm video (Multiple choices). At the same time you need to set alarm record in schedule interface (Main Menu->Setting->Schedule) and select schedule record in manual record interface (Main Menu->Advance->Manual Record).
- Latch: Here is for you to set proper delay duration. Value ranges from 10 to 300 seconds. System automatically delays specified seconds in turning off alarm and activated output after external alarm cancelled.
- Tour: Here you can enable tour function when an alarm occurs. System supports 1/8-window tour. Please note the tour setup here has higher priority than the tour setup you set in the Display interface. Once there two tours are both enabled, system can enable the alarm tour as you set here when an alarm occurred. If there is no alarm, system implements the tour setup in the Display interface.
- Snapshot: System can snapshot corresponding channel when an alarm occurs. Please note the activation snapshot has the higher priority than schedule snapshot. If you have enabled these two types at the same time, system can activate the activation snapshot when an alarm occurs, and otherwise system just operates the schedule snapshot.
- Video matrix Check the box here to enable this function. When an alarm occurs, SPOT OUT port displays device video output. It displays video (1-window tour) from alarm activation channel you select at the Record channel item.
- Log: Check the box here, system can record local alarm log.
- Buzzer: Highlight the icon to enable this function. The buzzer beeps when an alarm occurs.
- Voice prompts: Check the box here to trigger audio broadcast function. You can select specified audio file here. System can play the audio file once the corresponding event occurs.

Please note, network alarm means the alarm signal from the TCP/IP. You can use NET SDK to activate network alarm. Comparing with the local alarm, there is no type, anti-dither, alarm upload function.

Please highlight icon  to select the corresponding function. After setting all the setups please click save button, system goes back to the previous menu.



Figure 4-154



Figure 4-155



Figure 4-156



Figure 4-157

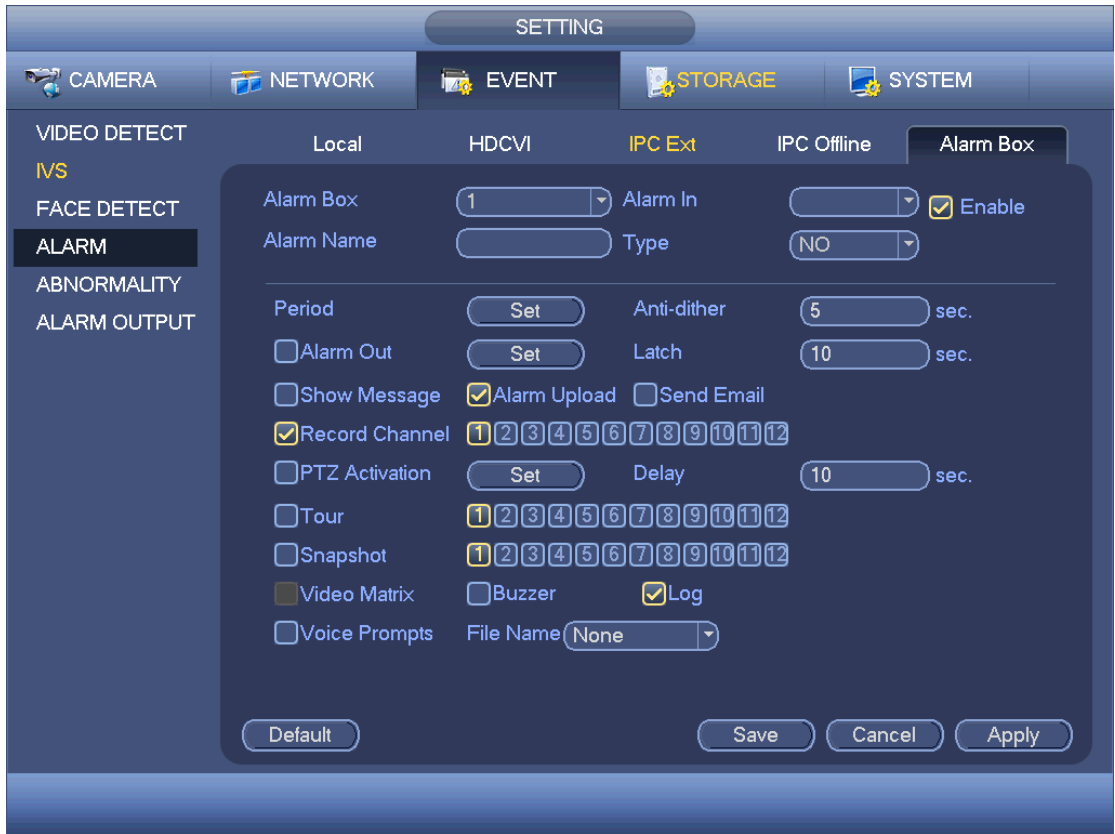

Figure 4-158

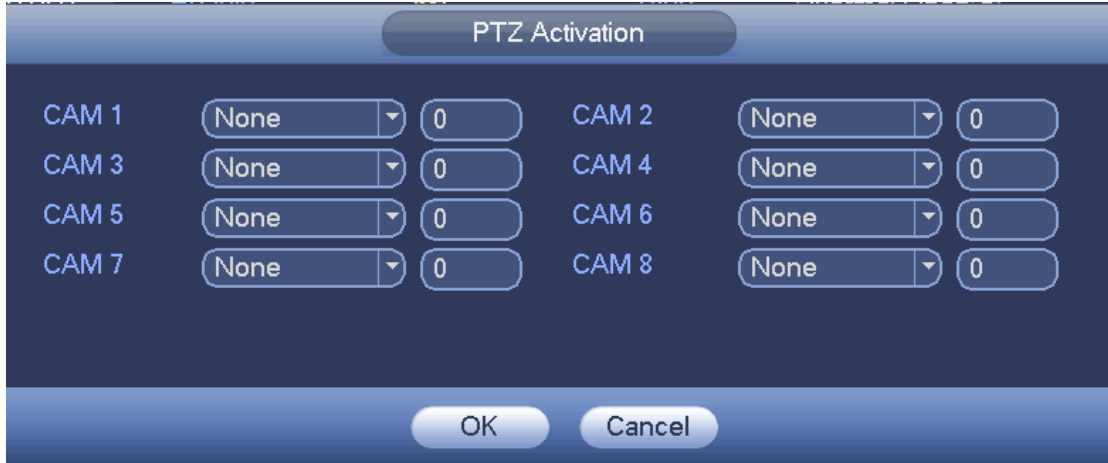

Figure 4-159

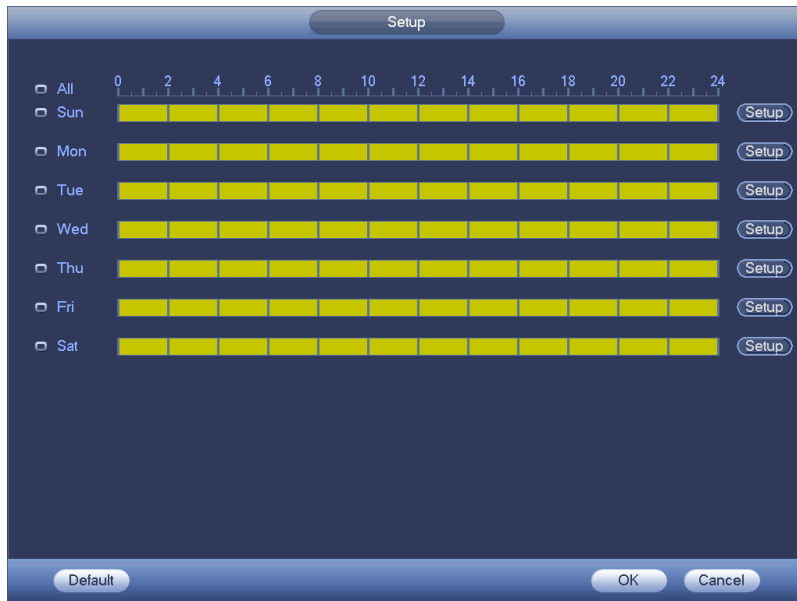

Figure 4-160



Figure 4-161

4.9.3.9 Abnormality

There are four types: HDD/Network/User/Device. Please note device interface is for some series only.

- ✧ HDD: HDD error, no disk, no space. See Figure 4-162 and Figure 4-163.
- ✧ Network: Disconnection, IP conflict, MAC conflict. See Figure 4-164.
- ✧ User: Illegal login. See Figure 4-165 .
- ✧ Device: High temperature, fan speed abnormal. See Figure 4-166.
- Alarm output: Please select alarm activation output port (multiple choices).

- Less than: System can alarm you when the HDD space is less than the threshold you set here (For HDD no space type only).
- Latch: Here you can set corresponding delaying time. The value ranges from 0s-300s. System automatically delays specified seconds in turning off alarm and activated output after external alarm cancelled. When the value is 0, there is no latch time.
- High temperature: In Device interface (Figure 4-166), select High temperature from the dropdown list, and then input the max temperature. The value ranges from 30°C ~ 90°C. Device can trigger an alarm once the case temperature is higher than the value you set.
- Fan speed abnormal: In Device interface (Figure 4-166), select Fan speed abnormal from the dropdown list, and then click the OK button after the Fan calibration. It can correct fan manually. Please note we recommend this function after you replaced or maintained the fan.
- Show message: system can pop up the message in the local screen to alert you when an alarm occurs.
- Alarm upload: System can upload the alarm signal to the network (including alarm center) if you enabled current function. For disconnection event, IP conflict event and MAC conflict event, this function is null.
- Send email: System can send out email to alert you when an alarm occurs.
- Buzzer: Highlight the icon to enable this function. The buzzer beeps when an alarm occurs.
- Log: Check the box here, system can record HDD event log.
- Voice prompts: Check the box here to trigger audio broadcast function. You can select specified audio file here. System can play the audio file once the corresponding event occurs.



Figure 4-162



Figure 4-163



Figure 4-164



Figure 4-165



Figure 4-166

4.9.3.10 Alarm Output

Here is for you to set proper alarm output such as auto, manual. See Figure 4-167.

Please highlight icon  to select the corresponding alarm output. Click Apply or Save to complete setup.



Figure 4-167

4.9.4 Storage

4.9.4.1 Basic

It is to manage HDD storage space.

Besides startup wizard and configuration wizard, from main menu->Setting->Storage->Basic, you can also go to the following interface.

Step 1 From main menu->Setting->Storage->Basic.

Enter Basic interface, See Figure 4-168.

Step 2 Set parameters.

- HDD full: It is to select working mode when hard disk is full. There are two options:
 - stop recording or rewrite.
- ◇ Stop: If current HDD is full while there is no idle HDD, then system stops recording,
- ◇ Overwrite: If the current HDD is full while there is no idle HDD, then system overwrites the previous files.

 **Note**

DVR does not overwrite the locked files.

- Pack duration: Here is for you to specify record duration. There are two ways for you to set.
 - ◇ Time length: It is to pack according to time. The value ranges from 1 to 60 minutes. Default value is 60 minutes.
 - ◇ File length: It is to pack according to file length. The default setup is 1024M. The value ranges from 128M to 2048M.
- Auto delete old files:
 - ◇ Never: Do not auto delete old files.
 - ◇ Customized: input customized period here, system can auto delete corresponding old files.

 **Note**

The deleted file is not recoverable if you enable auto delete old files function.



Figure 4-168

4.9.4.2 Schedule

4.9.4.2.1 Record

 **Note**



You need to have proper rights to implement the following operations. Please make sure the HDDs have been properly installed.

After the system booted up, it is in default 24-hour regular mode. You can set record type and time in schedule interface.

In the main menu, from Setting->Storage->Schedule, you can go to schedule menu. See Figure 4-172.

Please note you need to go to main menu->Setting->System->General->Holiday to set holiday date first, otherwise, there is no holiday setup item.

- Channel: Please select the channel number first. You can select “all” if you want to set for the whole channels.

✧ : Sync connection icon. Select icon  of several dates, all checked items can be edited together. Now the icon is shown as .

✧ : Click it to delete a record type from one period.

- Record Type: Please check the box to select corresponding record type. There are four types: Regular/MD (motion detect)/Alarm/MD&Alarm.
- Week day: There are eight options: ranges from Saturday to Sunday and all.
- Holiday: It is to set holiday setup. Please note you need to go to the General interface (Main Menu->System->General) to add holiday first. Otherwise you cannot see this item.
- Pre-record: System can pre-record the video before the event occurs into the file. The value ranges from 1 to 30 seconds depending on the bit stream.
- Redundancy: System supports redundancy backup function. You can highlight Redundancy button to activate this function. Please note, before enable this function, please set at least one HDD as redundant. (Main menu->Setting->Storage->HDD Manager). **Please note this function is null if there is only one HDD.**
- Period setup: Click button  after one date or a holiday, you can see an interface shown as in Figure 4-173. There are four record types: regular, motion detection (MD), Alarm, MD & alarm.

Please following the steps listed below to draw the period manually.

- ✧ Select a channel you want to set. See Figure 4-169.



Figure 4-169

- ✧ Set record type. See Figure 4-170.



Figure 4-170

- ✧ Please draw manually to set record period. There are six periods in one day. See Figure 4-171.

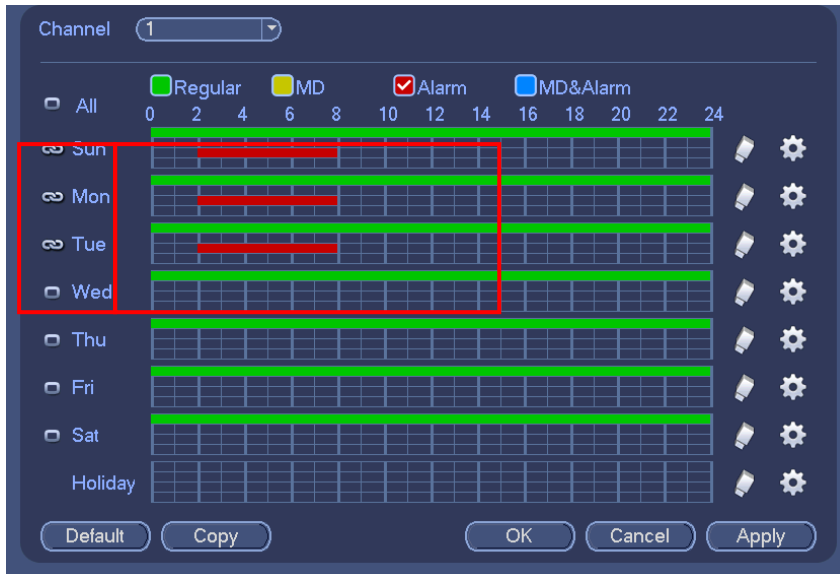



Figure 4-171

Please highlight icon  to select the corresponding function. Click Apply or Save to complete setup.

There are color bars for your reference. Green color stands for regular recording, yellow color stands for motion detection and red color stands for alarm recording. The white means the MD and alarm record is valid. Once you have set to record when the MD and alarm occurs, system will not record neither motion detect occurs nor the alarm occurs.

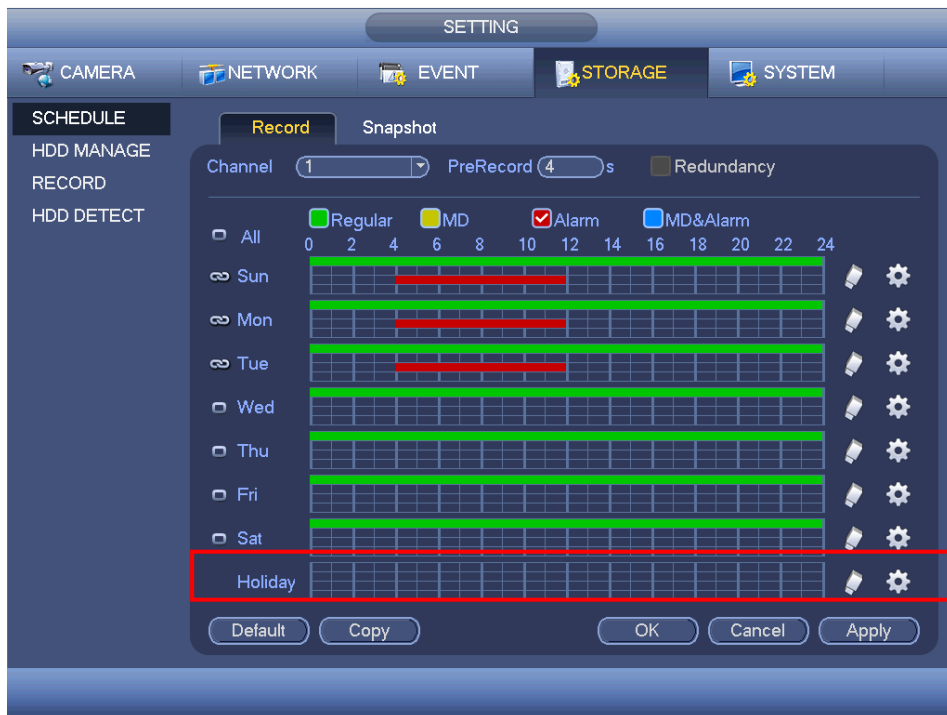

Figure 4-172



Figure 4-173

4.9.4.2.1.1 Quick Setup

Copy function allows you to copy one channel setup to another. After setting in channel 1, click Copy button, you can go to interface Figure 4-174. You can see current channel name is grey such as channel 1. Now you can select the channel you want to paste such as channel 5/6/7. If you want to save current setup of channel 1 to all channels, you can click the first box "ALL". Click the OK button to save current copy setup. Click the OK button in the Encode interface, the copy function succeeded.



Figure 4-174

4.9.4.2.1.2 Redundancy

Redundancy function allows you to memorize record file in several disks. When there is file damage occurred in one disk, there is a spare one in the other disk. You can use this function to maintain data reliability and safety.

- In the main menu, from Setting->Storage-> Schedule, you can highlight redundancy button to enable this function.
- In the main menu, from Main menu->Setting->Storage->HDD Manager, you can set one or more disk(s) as redundant. You can select from the dropdown list. System auto overwrites old files once hard disk is full.

Please note only read/write disk or read-only disk can backup file and support file search function, so you need to set at least one read-write disk otherwise you cannot

record video.

 **Note**

- If current channel is not recording, current setup gets activated when the channel begin recording the next time.
- If current channel is recording now, current setup will get activated right away, the current file will be packet and form a file, then system begins recording as you have just set.

After all the setups please click save button. .

Playback or search in the redundant disk.

There are two ways for you to playback or search in the redundant disk.

- Set redundant disk(s) as read-only disk or read-write disk (Main menu->Setting->Storage->HDD Manager)). System needs to reboot to get setup activated. Now you can search or playback file in redundant disk.
- Dismantle the disk and play it in another PC.

4.9.4.2.2 Snapshot

4.9.4.2.2.1 Schedule Snapshot

- On the preview interface, right click mouse and then select Manual->Record, or in the main menu, from Setting->Storage->Record, check the box to enable snapshot function of corresponding channels. See Figure 4-175.
- In main menu, from Setting->Camera->Encode->Snapshot interface, here you can input snapshot mode as regular, size, quality and frequency. See Figure 4-176.
- In main menu, from Setting->Camera->Encode->Schedule interface, please enable snapshot function. See interface on the right of Figure 4-177.

Please refer to the following figure for detailed information.

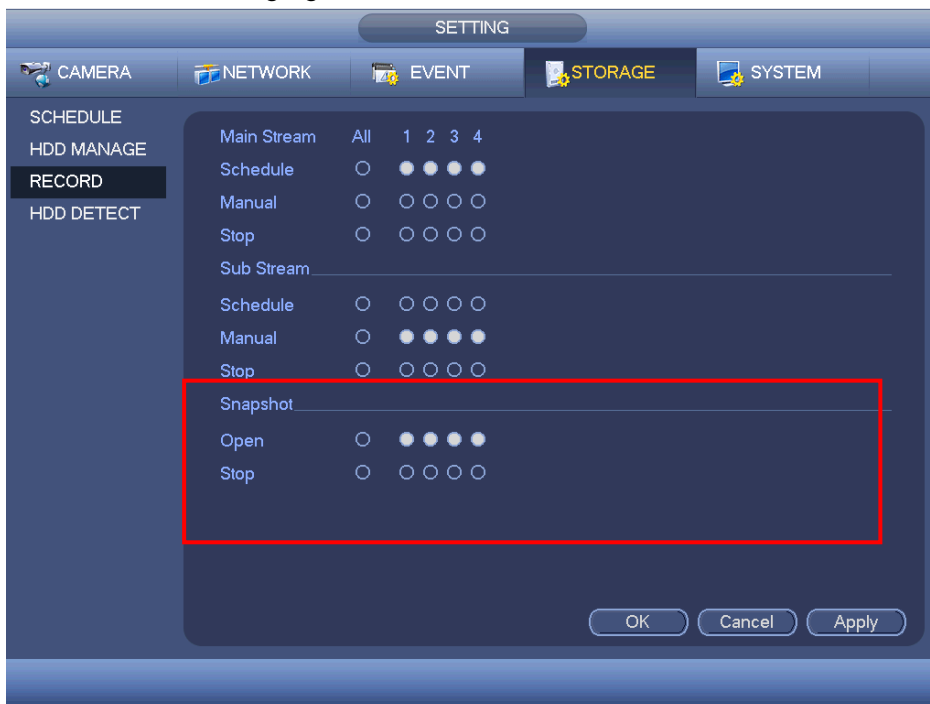

Figure 4-175

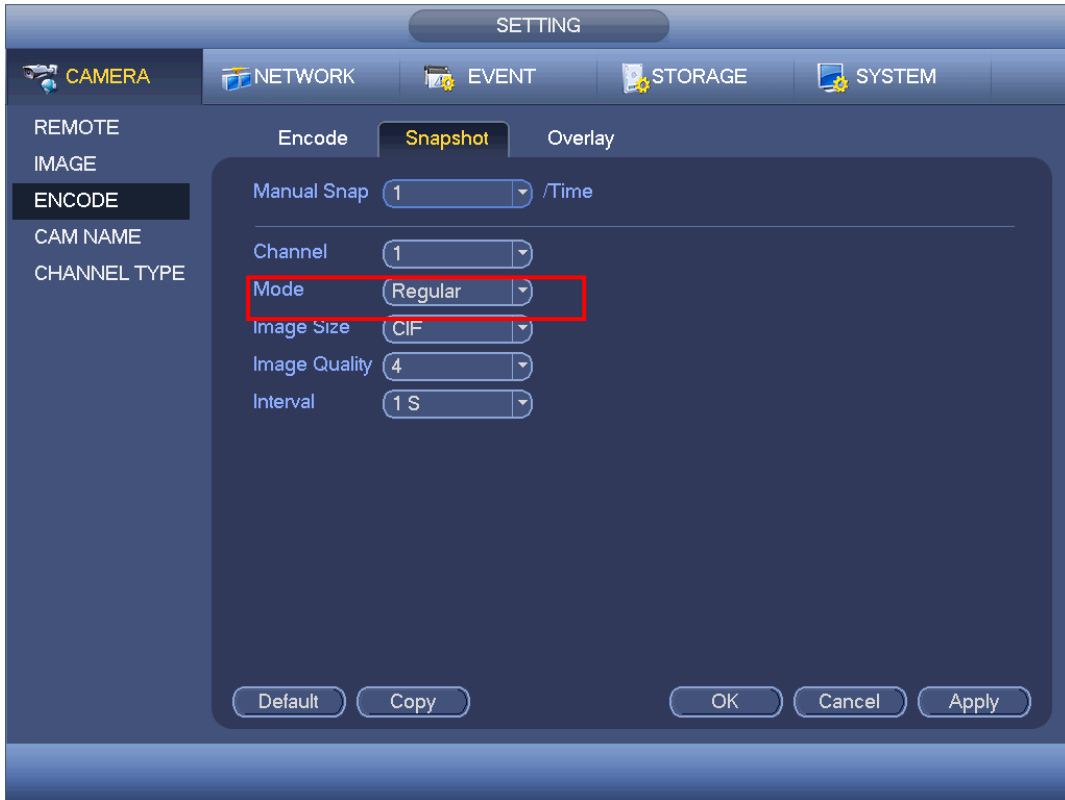

Figure 4-176

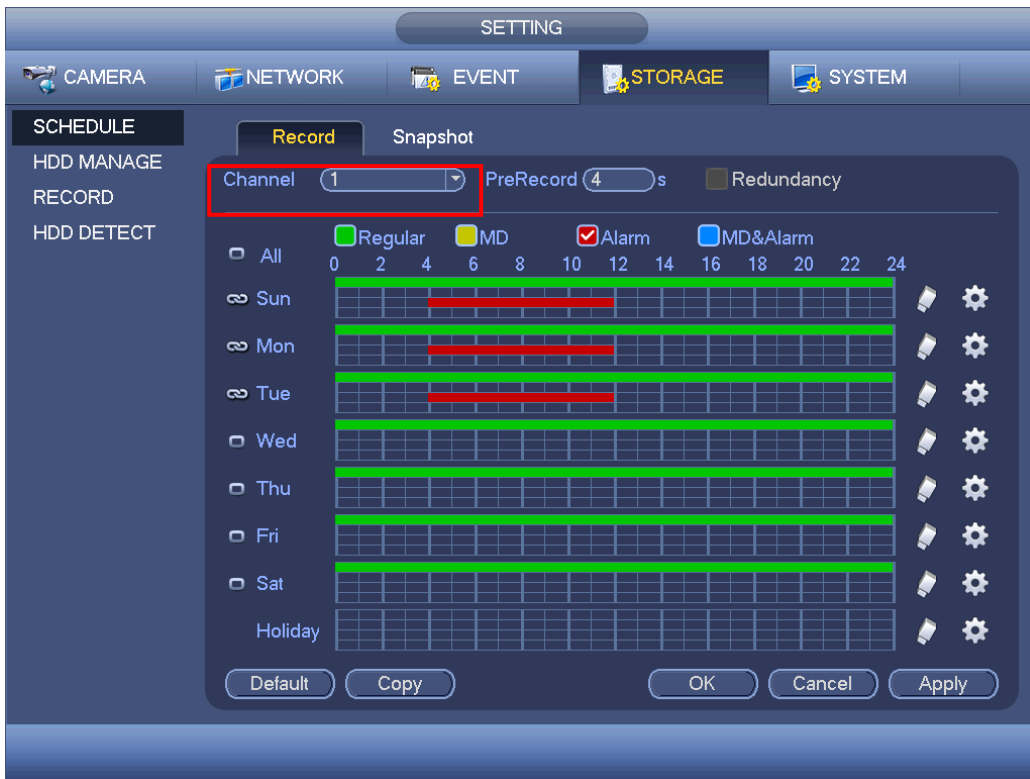

Figure 4-177

4.9.4.2.2.2 Trigger Snapshot

Please follow the steps listed below to enable the activation snapshot function. After you enabled this function, system can snapshot when the corresponding alarm occurred.

- In main menu, from Setting->Camera->Encode->Snapshot interface, here you can input snapshot mode as trigger, size, quality and frequency. See Figure 4-178.
- In main menu, from Setting->Event->Detect, please enable snapshot function for specified channels (Figure 4-179). Or in main menu, from Setting->Event->Alarm (Figure 4-180) please enable snapshot function for specified channels.



Figure 4-178

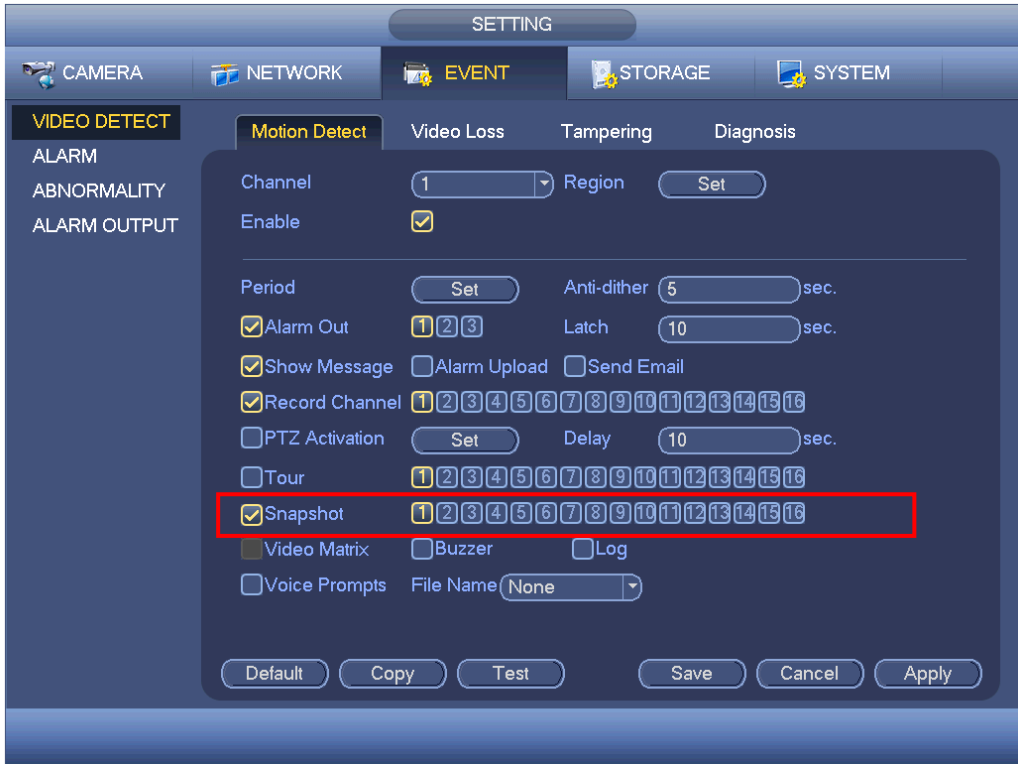

Figure 4-179

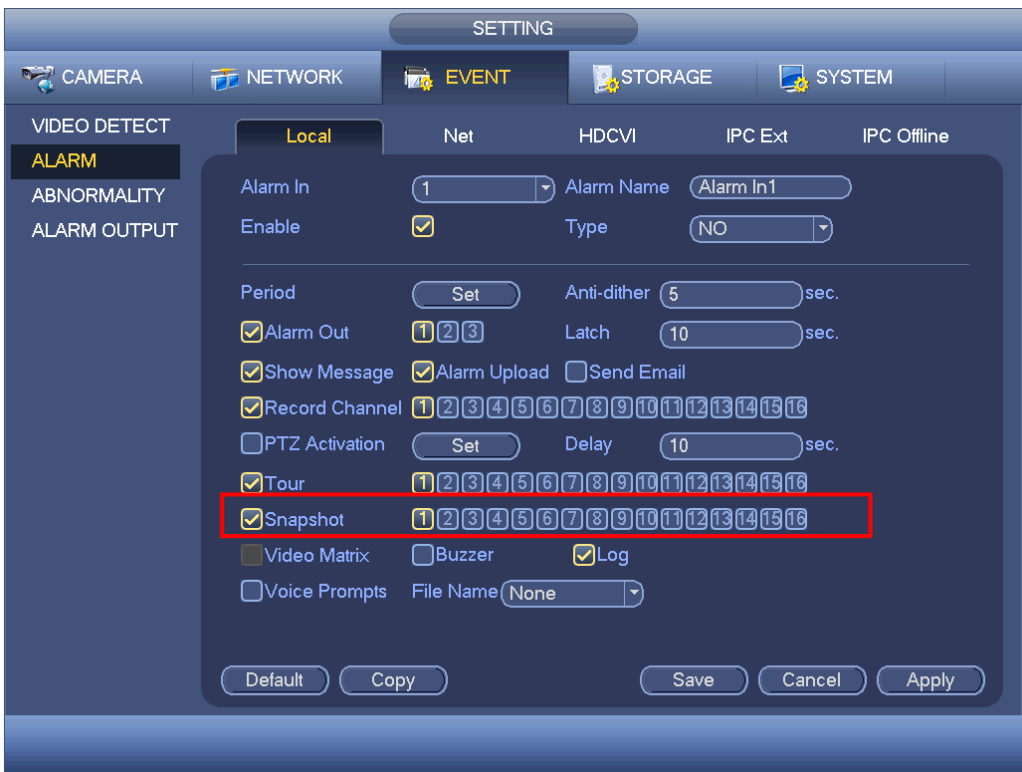

Figure 4-180

4.9.4.2.2.3 Priority

Please note the activation snapshot has the higher priority than schedule snapshot. If you have enabled these two types at the same time, system can activate the activation snapshot when an alarm occurs, and otherwise system just operates the schedule snapshot.

4.9.4.2.2.4 Image FTP

In the main menu, from Setting->Storage->FTP, you can set FTP server information. Please enable FTP function and then click save button. See Figure 4-181.

Please boot up corresponding FTP server.

Please enable schedule snapshot (Chapter 4.9.4.2.2.1) or activation snapshot (Chapter 4.9.4.2.2.2) first, now system can upload the image file to the FTP server.

Note

SFTP is encryption transmission while FTP is not. We strongly recommend you use SFTP function. The SFTP port value is 22 and the FTP port value is 21.



Figure 4-181

4.9.4.3 HDD Manager

Here is for you to view and implement hard disk management. See Figure 4-182.

You can see current HDD type, status, capacity and etc. The operation includes format HDD, and change HDD property (read and write/read-only/redundancy).

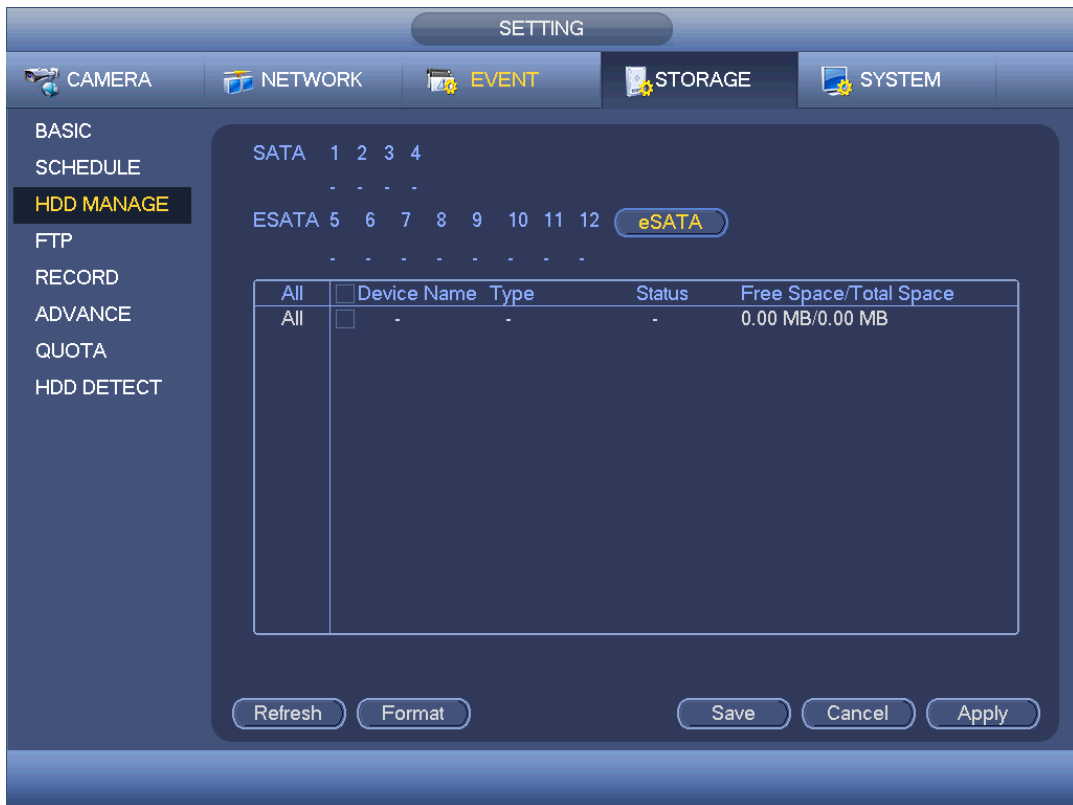

Figure 4-182

4.9.4.4 FTP

It is to backup record file or image to the FTP to storage or view.

Before the operation, please download or purchase the FTP service tool and install on the PC.



Note

For the FTP user, please set FTP folder write right, otherwise system cannot upload the image.

Step 1 From main menu->Setting->Storage->FTP, enter FTP interface. See Figure 4-183.

Step 2 Set parameters.

Here you can input FTP server address, port and remote directory. When remote directory is null, system automatically create folders according to the IP, time and channel.

- Host IP: The host IP you have installed the FTP server.
- Host port: The default setup is 21.
- User name/Password: The account for you to access the FTP server.
- Remote directory: The folder you created under the root path of the FTP according to the corresponding rule.
 - ✧ If there is no remote directory, system can auto create different directories according to the IP, time and channel.
 - ✧ If there is remote directory, system can create corresponding folder under the

FTP root path and then create different folders according to IP address, time and channel.

- File length: File length is upload file length. When setup is larger than the actual file length, system will upload the whole file. When setup here is smaller than the actual file length, system only uploads the set length and auto ignore the left section. When interval value is 0, system uploads all corresponding files.
- Image upload interval: It is the image upload interval. If the image upload interval is larger than the image snapshot frequency, system just uploads the lasted image.
 - ◇ If the image interval is 5 seconds and the snapshot frequency is 2 seconds, system will send out the latest image at the buffer at 5 seconds.
 - ◇ If the image upload interval is smaller than the snapshot frequency, system will upload at the snapshot frequency. For example, if the image interval is 5 seconds and the snapshot frequency is 10 seconds, system will send out the image at 10 seconds.
 - ◇ From main menu->Setting->Camera->Encode->Snapshot to set snapshot frequency.
- Channel: Select a channel from the dropdown list and then set week, period and record type.
- Week day/Period: Please select from the dropdown list and for each day, you can set two periods.
- Type: Please select uploaded record type (Alarm/intelligent/motion detect/regular). Please check the box to select upload type.

Step 3 Click the Test button, you can see the corresponding dialogue box to see the FTP connection is OK or not.

Step 4 Click Apply or Save to complete setup.



Figure 4-183

4.9.4.5 Advanced

It is to set HDD group, and HDD group setup for main stream, sub stream and snapshot operation

4.9.4.5.1 HDD



CAUTION

HDD group and quota mode cannot be valid at the same time. System needs to restart once you change the mode here.

Step 1 From main menu->Setting->Storage->Advanced->HDD.

Enter HDD interface. See Figure 4-184.

Step 2 Set parameters.

- HDD: Here you can view the HDD amount the device can support.
- Group: It lists the HDD Group number of current hard disk.



Figure 4-184

- Step 3 Select the correspond group from the dropdown list.
- Step 4 Click main stream/sub stream/snapshot button to set corresponding HDD group information. See Figure 4-185.



Figure 4-185



Figure 4-186



Figure 4-187

Step 5 Click Apply or Save to complete setup.

4.9.4.6 Record

4.9.4.6.1 Record Control

Note

You need to have proper rights to implement the following operations. Please make sure the HDD has been properly installed.

There are three ways for you to go to manual record menu.

- Right click mouse and then select Manual->Record.
- In the main menu, from Setting->Storage->Record.
- In live viewing mode, click record button in the front panel or record button in the remote control.

System supports main stream and sub stream. There are three statuses: schedule/manual/stop. See Figure 4-188. Please highlight icon“○” to select corresponding channel.

- Manual: The highest priority. After manual setup, all selected channels will begin ordinary recording.
- Schedule: Channel records as you have set in recording setup (Main Menu->Setting->System->>Schedule)
- Stop: Current channel stops recording.

- All: Check All button after the corresponding status to enable/disable all-channel schedule/manual record or enable/disable all channels to stop record.

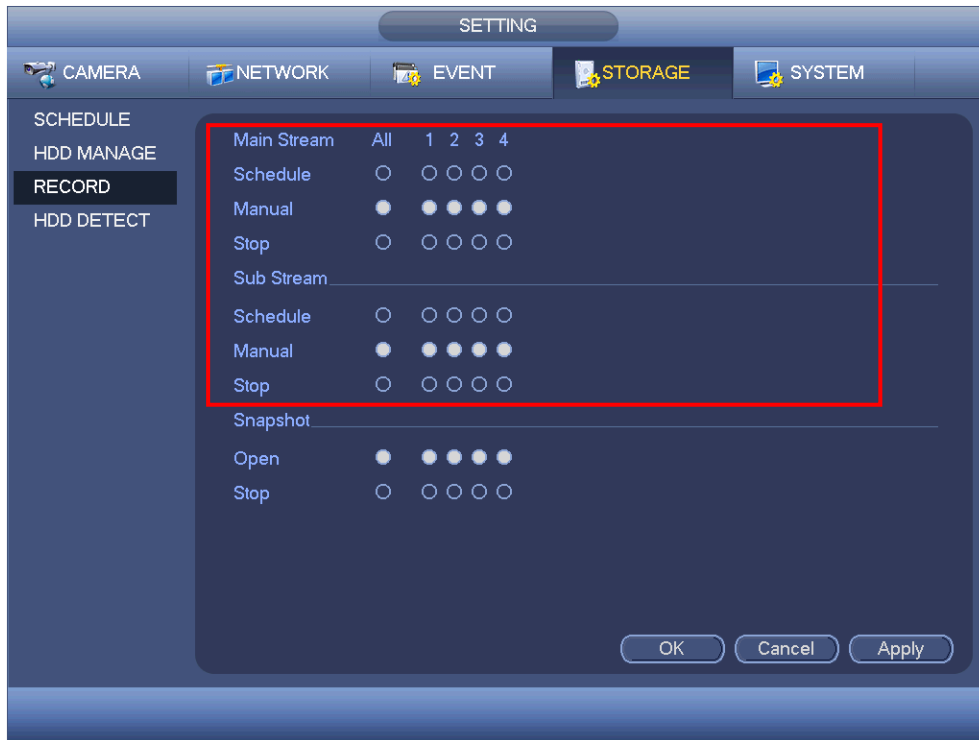

Figure 4-188

4.9.4.6.2 Snapshot Operation

Check the corresponding box to enable/disable schedule snapshot function. See Figure 4-189.

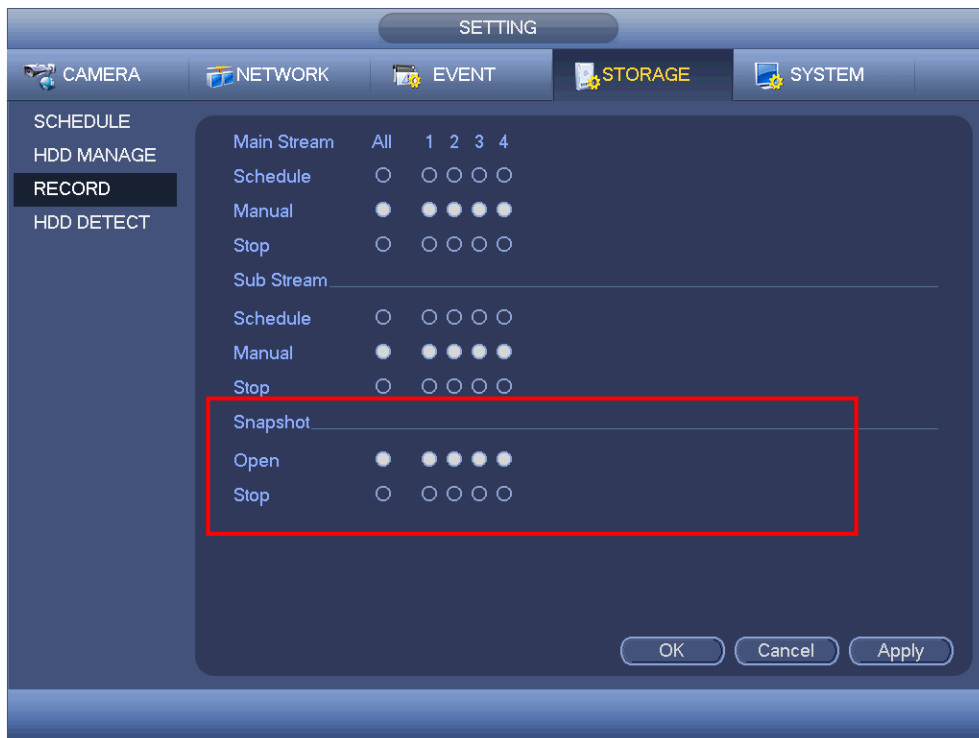

Figure 4-189

Tips

You can check All button after the corresponding status to enable/disable all-channel snapshot function.

Click Apply or Save to complete setup.

4.9.4.7 Quota

It is to set channel storage capacity.



CAUTION

- This function is for some series only.
- HDD group and quota mode cannot be valid at the same time.
- System needs to restart once you change the mode here.

Step 1 From main menu->Setting->Storage->Quota.

Enter quota interface. See Figure 4-190.



Figure 4-190

Step 2 Select a channel from the dropdown list and then select corresponding HDD quota.

Step 3 Click Apply or Save to complete setup.

Step 4 Click Statistics to view HDD capacity you set for each channel. See Figure 4-191.

Statistics		
2	Channel	Quota
1	Channel 1	1.02 TB
2	Other Channels	1.25 TB

Figure 4-191

4.9.4.8 HDD Detect

The HDD detect function is to detect HDD current status so that you can clearly understand the HDD performance and replace the malfunction HDD.

There are two detect types:

- Quick detect is to detect via the universal system files. System can quickly complete the HDD scan. If you want to use this function, please make sure the HDD is in use now. If the HDD is removed from other device, please make sure the write-data once was full after it installed on current device.
- Global detect adopts Windows mode to scan. It may take a long time and may affect the HDD that is recording.

4.9.4.8.1 Manual Detect

The manual detect interface is shown as below. See Figure 4-192.

Please select detect type and HDD. Click start detect to begin. You can view the corresponding detect information. See Figure 4-193.

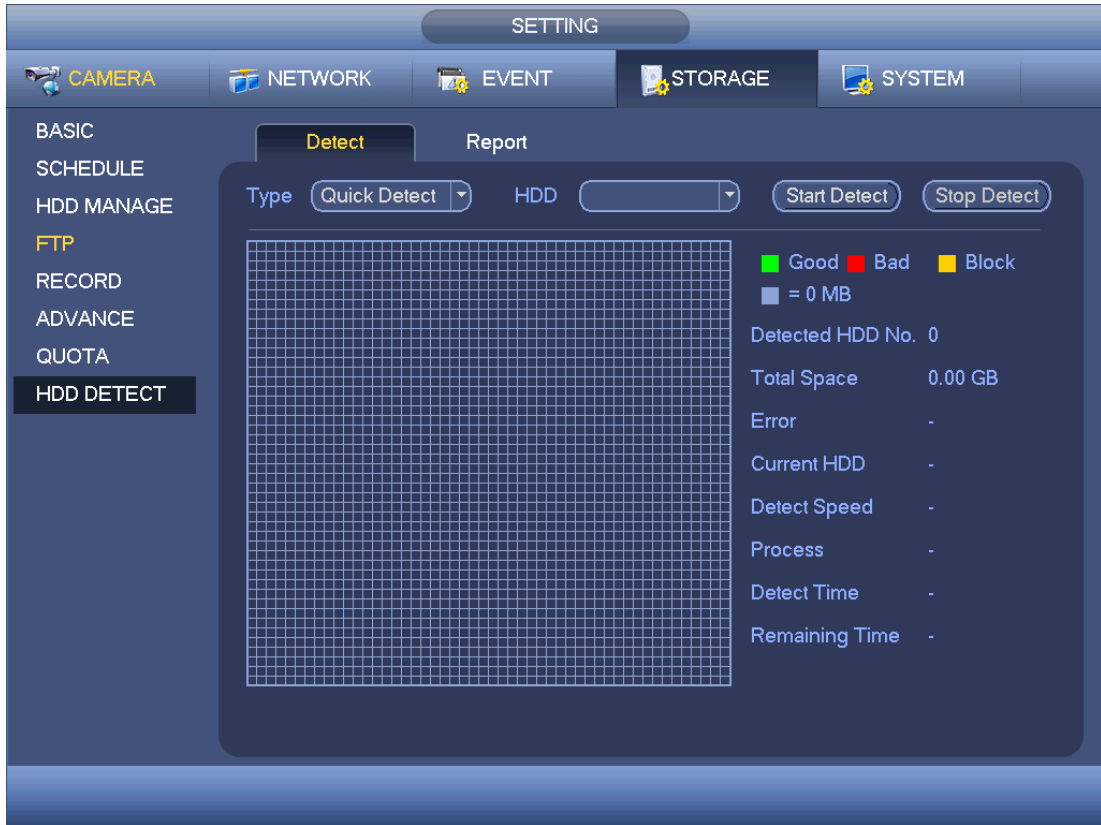

Figure 4-192

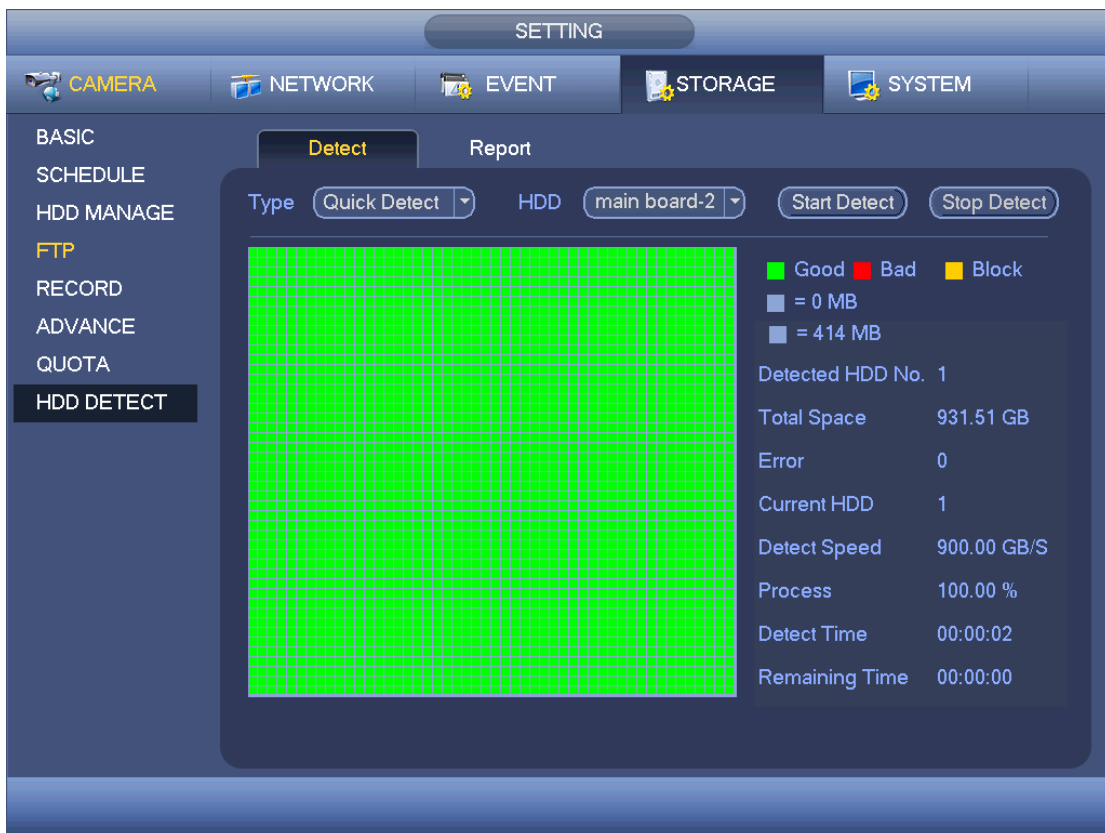

Figure 4-193

4.9.4.8.2 Detect Report

After the detect operation, you can go to the detect report to view corresponding information.

The detect report interface is shown as below. See Figure 4-194.

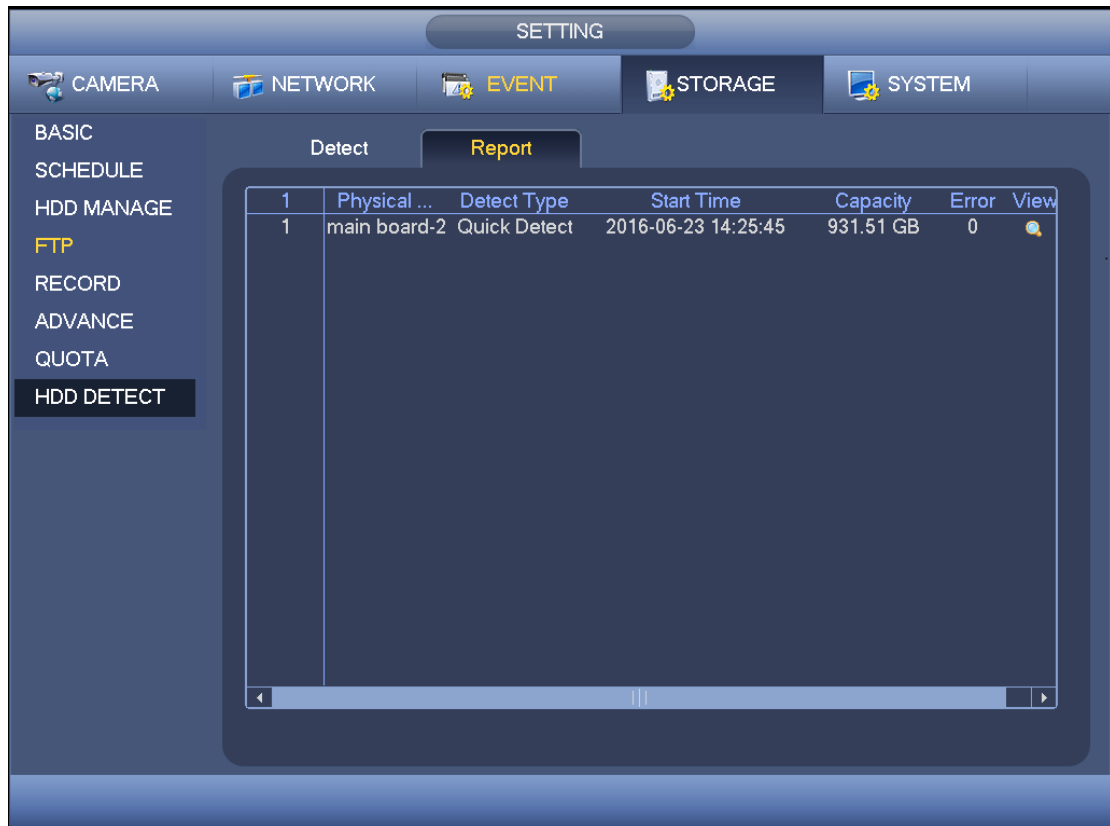

Figure 4-194

Click the item you can see the detailed information such as detect result. See Figure 4-195.



Figure 4-195

4.9.5 System

4.9.5.1 General

4.9.5.1.1 Device

General setting includes the following items. See Figure 4-196.

- Device ID: Please input a corresponding device name here.
- Device No: Here you can set device number.
- Language: System supports various languages: Chinese (simplified), Chinese (Traditional), English, Italian, Japanese, French, Spanish (All languages listed here are optional. Slight difference maybe found in various series.)
- Video standard: There are two formats: NTSC and PAL.
- Instant playback: It is to set playback time you can view in the preview interface. The value ranges from 5 to 60 minutes.
- Auto logout: Here is for you to set auto logout interval once login user remains inactive for a specified time. Value ranges from 0 to 60 minutes.
- Monitor channels when logout: Here you can set channels you want to view when your account has logged out. Click the button and then cancel the channel name box, you need to login to view the corresponding video. The channel window displays  in preview interface.
- IPC Time Sync: You can input an interval here to synchronize the DVR time and IPC time.

- Navigation bar: Check the box here, system displays the navigation bar on the interface.
- Mouse property: You can set double click speed via dragging the slide bard. You can Click Default button to restore default setup.

Click Apply or Save to complete setup.

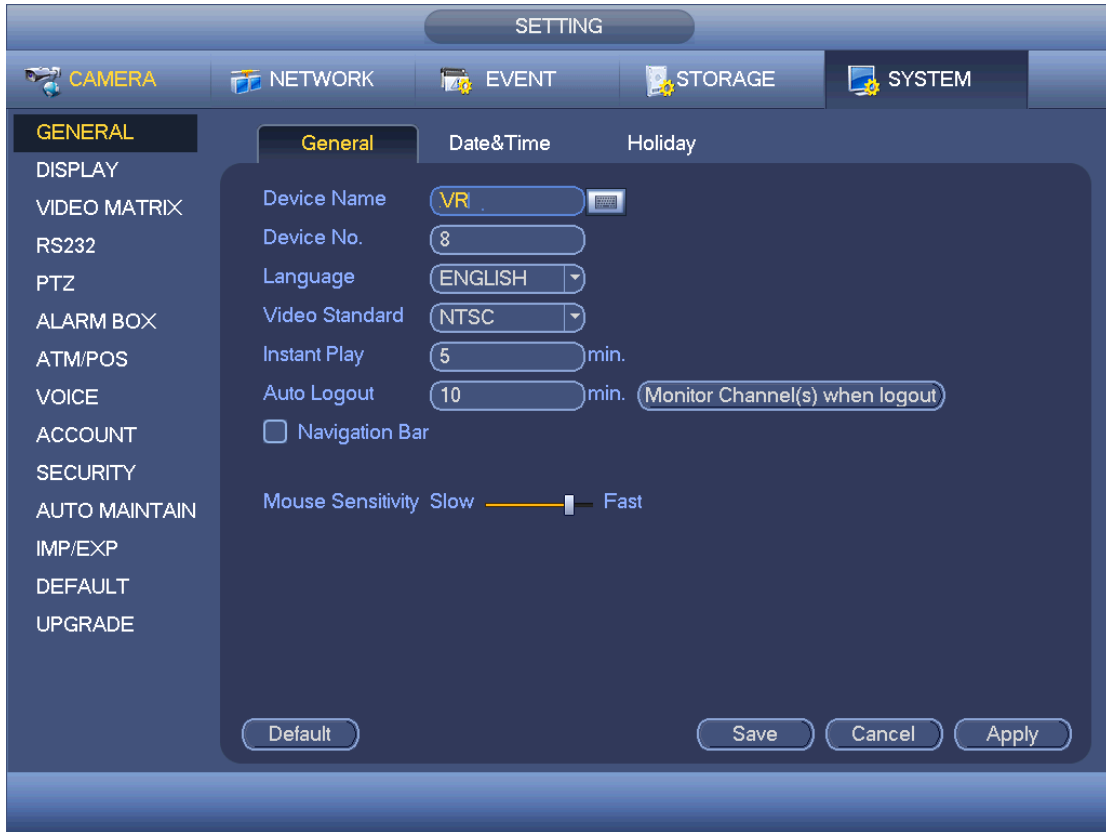

Figure 4-196

4.9.5.1.2 Date and Time

The interface is shown as in Figure 4-197.

- Date format: There are three types: YYYY-MM-DD: MM-DD-YYYY or DD-MM-YYYY.
- Date separator: There are three denotations to separate date: dot, beeline and solidus.
- DST: Here you can set DST time and date. Here you can set start time and end time by setting corresponding week setup or by setting corresponding date setup.
- NTP: It is to set NTP server information.

Click Apply or Save to complete setup.



Figure 4-197

4.9.5.1.3 Holiday

Holiday setup interface is shown as in Figure 4-198. Click Add new holiday button, you can input new holiday information. See Figure 4-199. Here you can set holiday name, repeat mode and start/end time.

Note

- When you enable Holiday settings and schedule setup at the same time, holiday setting has the priority. If the selected day is a holiday, then system records as you set in holiday setting. If it is not a holiday, system records as you set in Schedule interface.
- Please note, there is no year setup on the holiday setup. For example, if you set 30th Oct, 2012 as a holiday, then the date of 30th Oct in each year will be set as a holiday.

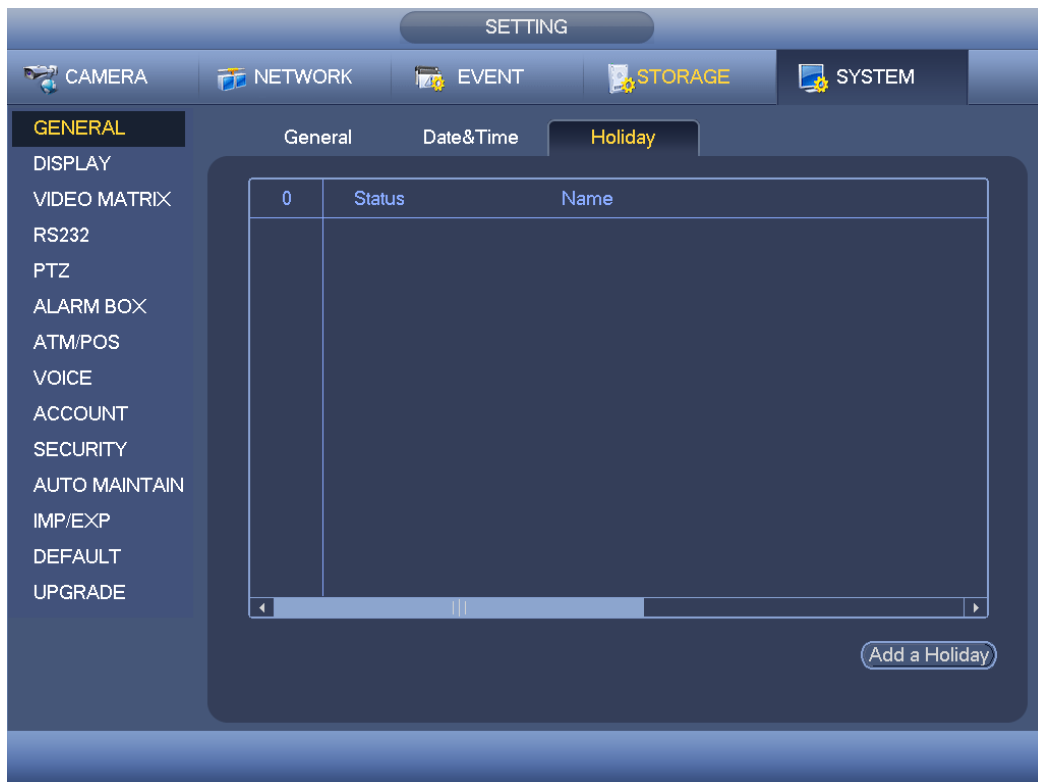

Figure 4-198



Figure 4-199

4.9.5.2 Display

4.9.5.2.1 Display

Display setup interface is shown as below. See Figure 4-200.

- Time display: You can select to display time or not when system is playback.
- Channel display: You can select to channel name or not when system is playback.
- Image original rate: Check the box here, the video can be displayed at its actual size.
- Transparency: Here is for you to adjust menu transparency. The higher the value is, the more transparent the menu is.
- Resolution: There are four options: 1920×1080, 1280×1024(default),1280×720,1024×768. Please note the system needs to reboot to activate current setup.
- Preview enhance: Check the box; it can optimize the video quality of the preview video.
- Video spot: Check the box to enable video matrix function.
- ✧ Check the box, select VGA or the HDMI as the video matrix output. The selected screen(s) only display(s) the channel video from the video matrix. Refer to chapter 4.9.5.3 Video matrix for detailed information.
- ✧ Cancel the box, the VGA and HDMI output the same video.
- Preview mode: Please select preview mode from the dropdown list. It includes two options. Please note this function is for some series product only.
- ✧ General: There is no information on the preview window.
- ✧ Human face: System displays human face information on the right pane of the preview window.

Please highlight icon  to select the corresponding function.

Click Apply or Save to complete setup.



Figure 4-200

4.9.5.2.2 TV Adjust

 **Note**

This function is for some series only.

Here is for you to adjust TV output setup. See Figure 4-201.

Please drag slide bar to adjust each item.

Click Apply or Save to complete setup.



Figure 4-201

4.9.5.2.3 Tour

Here you can activate tour function. Click Setup button, you can see an interface shown as in Figure 4-202



- Enable tour: Highlight box here to enable this function.
- Interval: System supports 1/8/-window tour. Input proper interval value here. The value ranges from 5-120 seconds. It is for schedule tour/alarm/motion detect tour.
- Split: You can select window split mode from the dropdown list.
- Channel group: It is to display all channel groups on current split mode. You can edit and delete a channel group here. Double click an item in the list; you can edit its channel group setup. Right now system max supports 32.
- Add: Under specified window split mode, click it to add channel group.
- Delete: Click it to remove selected channel group.

- Move up: Click it to move current selected channel up.
- Move down: Click it to move current selected channel down.
- Default: Click it to restore default setup.

Tips:

- Use mouse or Shift button to switch  and  button to enable /disable tour. 

 means the tour function is enabled and  means tour function is disabled.

- On the navigation bar, click  or  to enable/disable tour function.

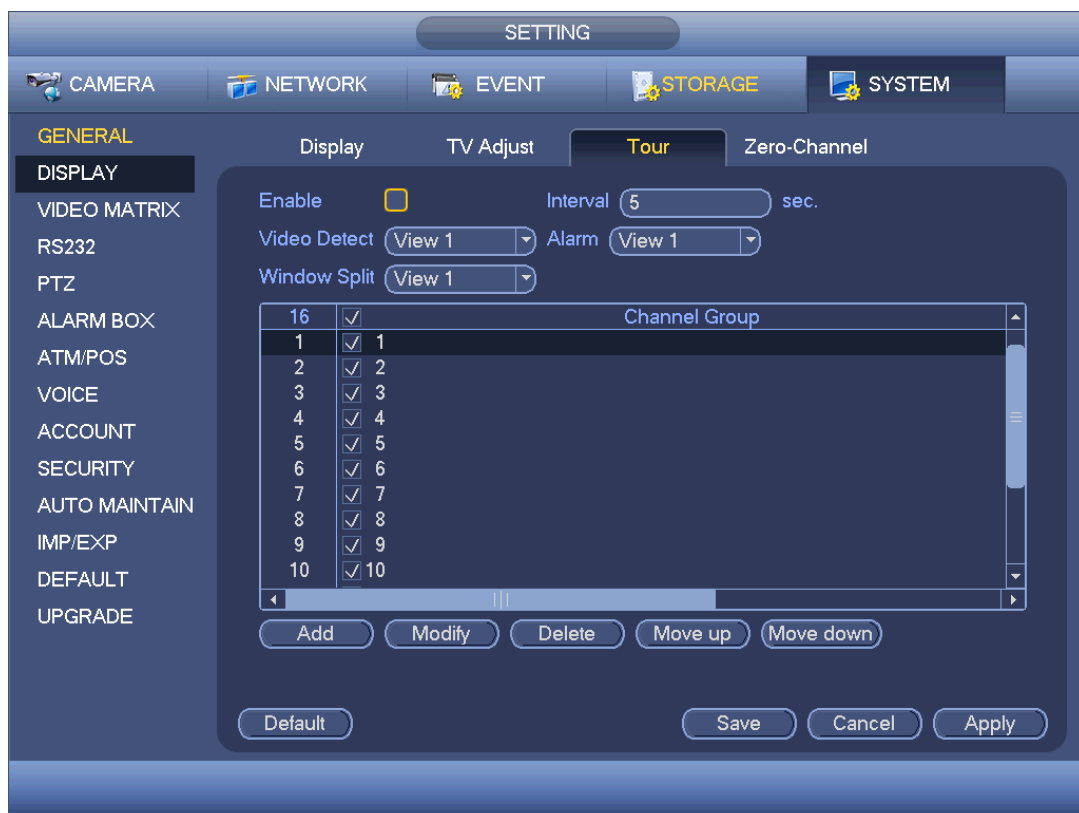

Figure 4-202

4.9.5.2.4 Zero-channel Encoding

Click zero-channel encoding button, you can go to the following interface. See Figure 4-203. Here you can enable and set zero-channel encoding function so that you can view several video sources at one channel.

- Enable: This function is disabled by default. Check the box here to enable this function so that you can control the zero-channel encoding function at the WEB.
- Compression: System default setup is H.264. You can set according to device capability.
- Resolution: The resolution value may vary due to different device capabilities. Please select from the dropdown list.
- Frame rate: The frame rate value may vary due to different device capabilities. Please select from the dropdown list.

- Bit Rate: The bit rate value may vary due to different device capabilities and frame rate setups. Please select from the dropdown list.
- Save: Click the Save button to save current setup. If this function is disabled, you cannot operate zero-channel encoding function at the WEB, the video is black or null even you operate when the function is disabled. After you enabled this function, login the Web and you can select zero-channel encoding mode at the right corner of the

interface . Select a mode; you can view the local preview video.



Figure 4-203

4.9.5.3 Video Matrix

Here you can set matrix output channel and its interval. You can set HDMI2 port tour and its interval See Figure 4-204.

- Enable tour: Check the box here to enable this function.
- Interval: Input proper interval value here.
- Resolution: The resolution of the tour window. Please note this function is for HDMI only.
- Split: You can select window split mode from the dropdown list. For BNC, it supports 1-split mode only. For HDMI, it supports 1/4/9/16-split mode. Some series product support 24/36-split. Please refer to the actual product.
- Add: Under specified window split mode, click it to add channel group. See Figure 4-205.

- **Modify:** Double click a channel or select a channel and then click Modify button, you can change current channel setup. See Figure 4-206.
- **Delete:** Click it to remove selected channel group.
- **Move up:** Click it to move current selected channel up.
- **Move down:** Click it to move current selected channel down.
- **Default:** Click it to restore default setup.

Click Apply or Save to complete setup.



Figure 4-204



Figure 4-205



Figure 4-206

4.9.5.4 RS232

RS232 interface is shown as below. There are five items. See Figure 4-207.

- Function: There are various devices for you to select. Console is for you to use the COM or mini-end software to upgrade or debug the program. The control keyboard is for you to control the device via the special keyboard. Transparent COM (adapter) is to connect to the PC to transfer data directly. Protocol COM is for card overlay function. Network keyboard is for you to use the special keyboard to control the device. PTZ matrix is to connect to the peripheral matrix control.
- Baud rate: You can select proper baud rate.
- Data bit: You can select proper data bit. The value ranges from 5 to 8.
- Stop bit: There are two values: 1/2.
- Parity: There are five choices: none/odd/even/space mark.

System default setup is:

- Function: Console
- Baud rate:115200
- Data bit:8
- Stop bit:1
- Parity: None

Click Apply or Save to complete setup.



Figure 4-207

4.9.5.5 PTZ

The pan/tilt/zoom setup includes the following items. Please select channel first. See Figure 4-208.

- PTZ type: There are two options: local/remote. Please select remote if you are connecting to the network PTZ.
- Control mode: You can select control mode from the dropdown list. There are two options: Serial/HDCVI. For HDCVI series product, please select HDCVI. The control signal is sent to the PTZ via the coaxial cable. For the serial mode, the control signal is sent to the PTZ via the RS485 port.
- Protocol: If the control mode is HDCVI, please select HDCVI protocol. The default setup is HDCVI3.0
- Address: input corresponding PTZ address.
- Baud rate: Select baud rate.
- Data bit: Select data bit.
- Stop bit: Select stop bit.
- Parity: There are three choices: none/odd/even.

Click Apply or Save to complete setup.



Figure 4-208

For digital channel, the interface is shown as below. See Figure 4-209.



Figure 4-209

4.9.5.6 Alarm Box

It is to view the peripheral connected alarm box state. See Figure 4-210.



Figure 4-210

4.9.5.7 ATM/POS

The ATM/POS function is for financial areas. It includes Sniffer, information analysis and title overlay function. The Sniffer mode includes COM and network.

4.9.5.7.1 COM Type

The COM interface is shown as below. See Figure 4-211.

- Protocol: Please select from the dropdown list.
- Setting: Click COM setting button, the interface is shown as in RS232 interface. Please refer to Chapter 5.3.4 RS232.
- Overlay channel: Please select the channel you want to overlay the card number.
- Overlay mode: There are two options: preview and encode. Preview means overlay the card number in the local monitor video. Encode means overlay the card number in the record file.
- Overlay Position: Here you can select the proper overlay position from the dropdown list.

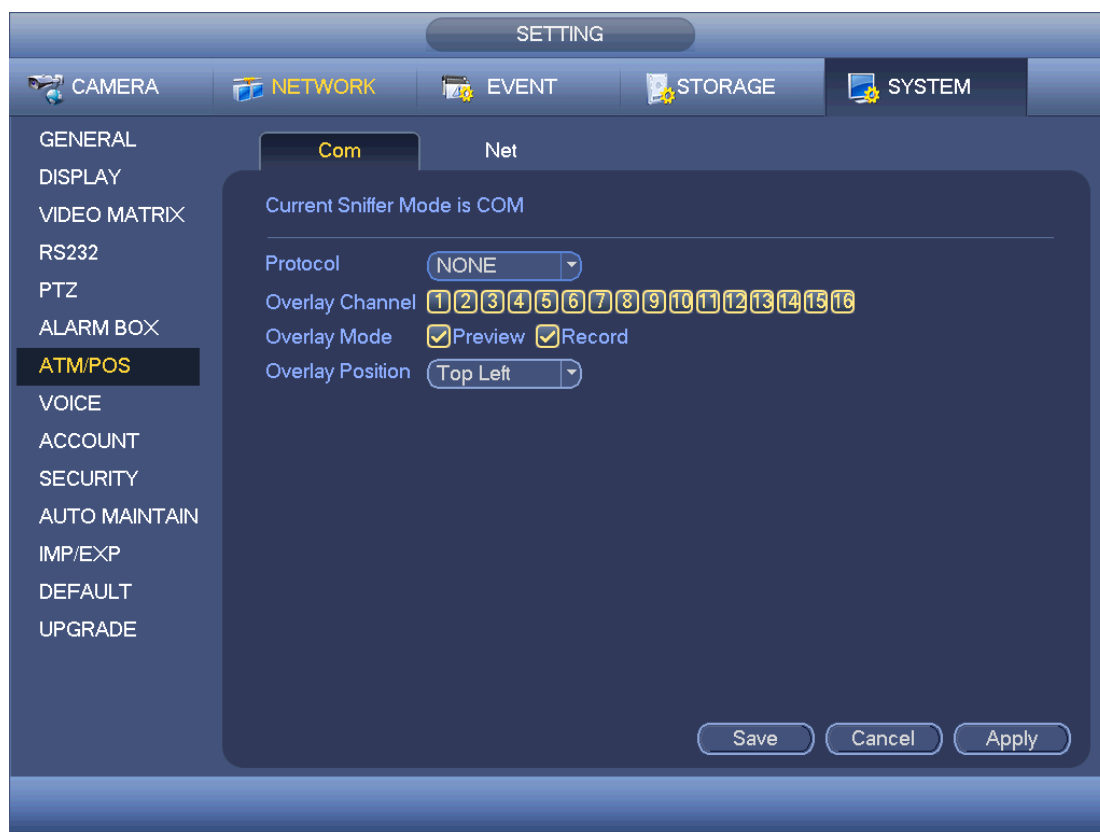

Figure 4-211

4.9.5.7.2 Network Type

The network type interface is shown as below. See Figure 4-212.

Please use network type if you using network to connect to the device. The interface is generally the same as the COM mode. The protocol depends on your self-developed protocol. The setup may vary since connected device or the protocol is not the same.

Here we take the ATM/POS protocol to continue.

- Protocol: It is to set COM sniffer protocol. You need to select protocol according to your own development situation.
- Overlay mode: There are two options: preview and encode. Preview means overlay the card number in the local monitor video. Encode means overlay the card number in the record file. You can view the corresponding information when playback.
- Overlay Position: Here you can select the proper overlay position from the dropdown list.
- Data group: There are total four groups IP.
- Source IP: Source IP refers to host IP address that sends out information (usually it is the device host.)
- Destination IP: Destination IP refers to other systems that receive information.
- Source port/destination port: Please input according to your own situation.
- Record channel: It is for you to check record channel. The record channel applies to one group (optional) only.
- Frame ID: Six frame ID groups verification can guarantee information validity and legal. You need to input start position, length, key and etc according to your

communication protocol and data packet contents.

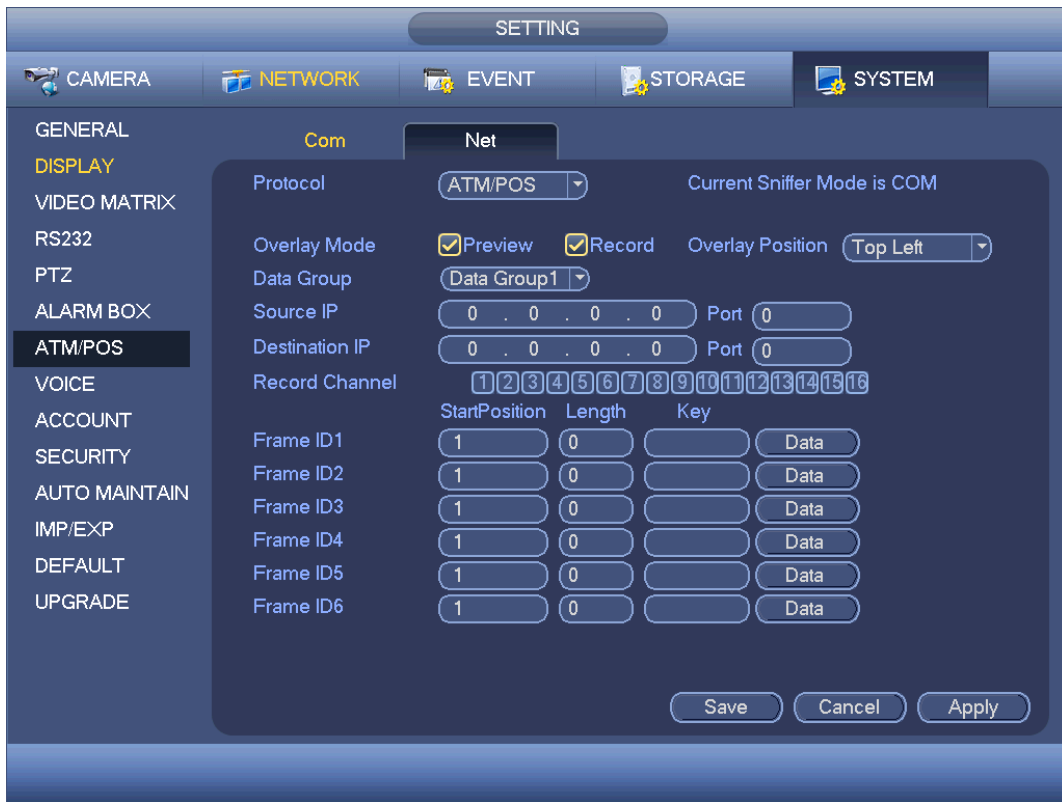

Figure 4-212

In Figure 4-212, click data button after frame ID the interface is shown as in Figure 4-213. Here you can set field start position, length, and overlay title.



Figure 4-213

4.9.5.8 Voice

The audio function is to manage audio files and set schedule play function. It is to realize

audio broadcast activation function.

4.9.5.8.1 File Manager

It is to add audio file, listen to the audio file, or rename/delete audio file. Here you can also set audio volume.

Step 1 From main menu->Setting->System->Voice->File Manager.

Enter file manager interface. See Figure 4-214.

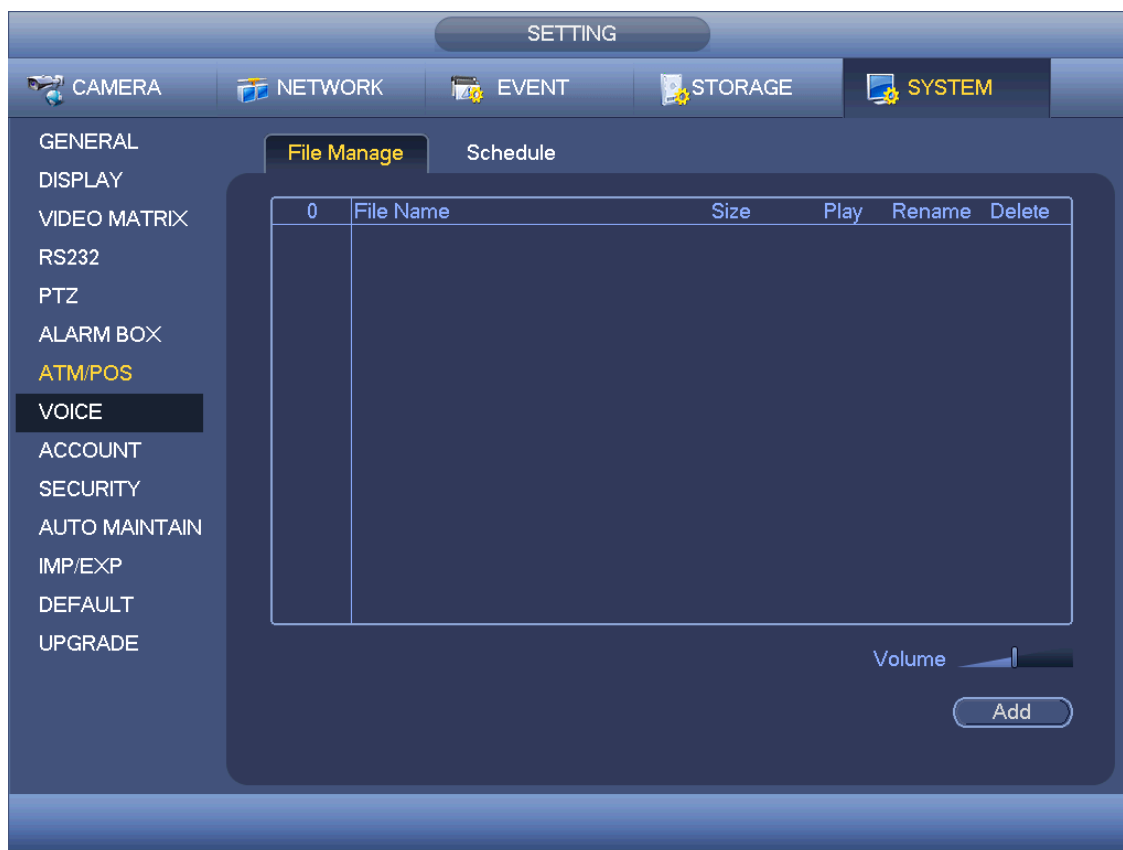

Figure 4-214

Step 2 Click Add button, it is to add audio file and import the audio file via the USB device. See Figure 4-215.

The newly added audio file will be saved on the HDD of the device; you do not need to connect to USB device again.



Figure 4-215

Step 3 Click OK button.

4.9.5.8.2 Schedule

It is to set schedule broadcast function. You can play the different audio files in the specified periods.

Step 1 From main menu->Setting->System->Voice->Schedule.

Enter Schedule interface. See Figure 4-216.

Step 2 Set parameters.

- Period: There are six periods. Check the box to enable current setup.
- File name: Select audio file you want to play.
- Interval: It is the audio file repeated interval in the specified period.
- Repeat: It is to set audio file repeat times in the specified period.
- Output port: There are two options: MIC (default)/audio. When reuse the MIC port and bidirectional talk port, the bidirectional port has the higher priority. Please make sure your purchased product has audio port, otherwise, you cannot use this function.

Step 3 Click Apply or Save to complete setup.



Note

- The audio file end time depends on the audio file size and the interval setup.
- Priority: Bidirectional talk>Event trigger alarm>Trial listening>Audio schedule broadcast.



Figure 4-216

4.9.5.9 Account

It is to manage users, user group and ONVIF user, set admin security questions.

Note

- For the user name, the string max length is 31-byte, and for the user group, the string max length is 15-byte. The user name can only contain English letters, numbers and “_”, “@”, “.”.
- The default user amount is 64 and the default group amount is 20. System account adopts two-level management: group and user. The user authorities shall be smaller than group authorities (The **admin** user authorities are set by default).
- For group or user management, there are two levels: admin and user. The user name shall be unique and one user shall only belong to one group.

4.9.5.9.1 Add User

Step 1 From main menu->Setting->System->Account->User.

Enter user interface. See Figure 4-217.



Figure 4-217

Step 2 Click Add user button in Figure 4-217.

The interface is shown as in Figure 4-218.



Figure 4-218

Step 3 Input the user name, password, select the group it belongs to from the dropdown list. Then you can check the corresponding rights for current user.

 **Note**

For convenient user management, usually we recommend the general user right is lower than the admin account.

Step 4 Click the Set button after the period, you can set valid period to use current account. See Figure 4-219.



Figure 4-219

Step 5 Click Set button, you can set six periods in one day. See Figure 4-220.

Step 6 Check the box after the period, you can enable current setup.

 **Note**

Check the box before the week; it is to save period settings to selected week day.



Figure 4-220

Step 7 Click OK button.

4.9.5.9.2 Modify user

From main menu->Setting->System->Account->User, click , you can go to the following interface to change user information. See Figure 4-221.



Figure 4-221

For **admin** user, you can change the email, enable/disable unlock pattern, change password prompt question, set security questions. See Figure 4-222.



Figure 4-222

- Input email information and then click Save, it is to set/change email address.
- Check the box to enable unlock pattern and then click , click Save to change unlock pattern.
- Set security question

Step 1 Click Security question, enter the following interface. See Figure 4-223.

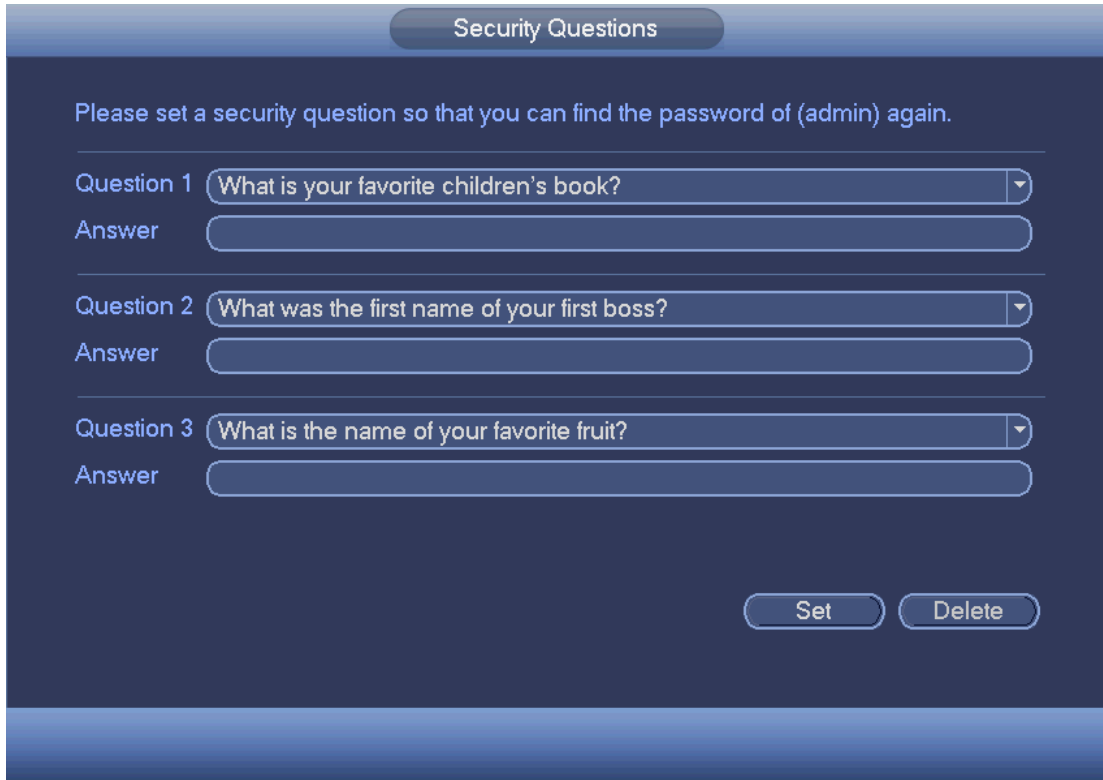

Figure 4-223

Step 2 Input answers and then click Save button.

After successfully set security questions, you can answer the security questions to reset admin password.

 **Note**

Select security questions from the dropdown list and then input the proper answers, click Delete button to reset security questions and answers again.

4.9.5.9.3 Change Password

In Figure 4-221, check the Modify password box, you can change password. Please input old password, and then input new password twice to confirm.

- Password/confirm password: The password ranges from 8 to 32 digitals. It can contain letters, numbers and special characters (excluding “”, “'”, “,”, “.”, “&”) . The password shall contain at least two categories. Usually we recommend the strong password.



WARNING

STRONG PASSWORD RECOMMENDED-For your device own safety, please create a strong password of your own choosing. We also recommend you change your password periodically especially in the high security system.

4.9.5.9.4 Add/Modify Group

Step 1 From main menu->Setting->System->Account->Group.

Enter add group interface. See Figure 4-224.



Figure 4-224

Step 2 Click add group button in Figure 4-224.

Enter Add group the interface. See Figure 4-225.

Step 3 Input group name and then input some memo information if necessary. Check the box to select authorities.

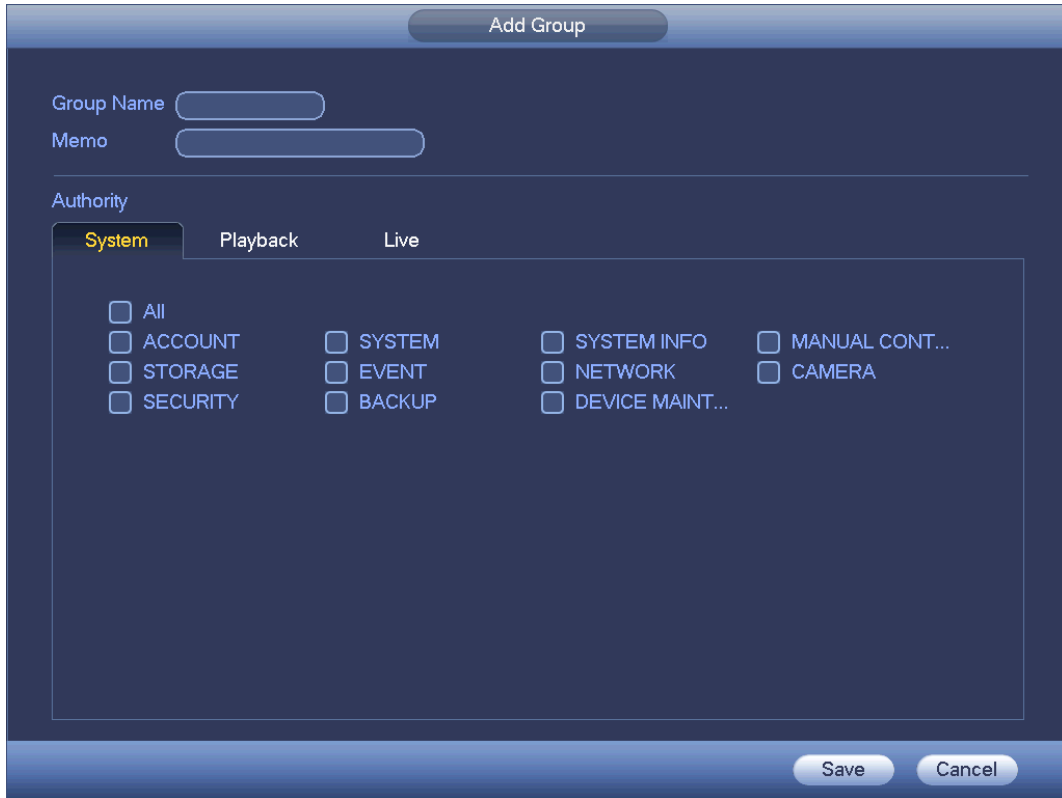

Figure 4-225

4.9.5.9.5 ONVIF User

When the camera from the third party is connected with the DVR via the ONVIF user, please use the verified ONVIF account to connect to the DVR. Here you can add/delete/modify user

Note

The default ONVIF user is **admin**. It is created after you initialize the DVR.

Step 1 From main menu->Setting->System->Account->ONVIF User.
Enter ONVIF interface. See Figure 4-226.

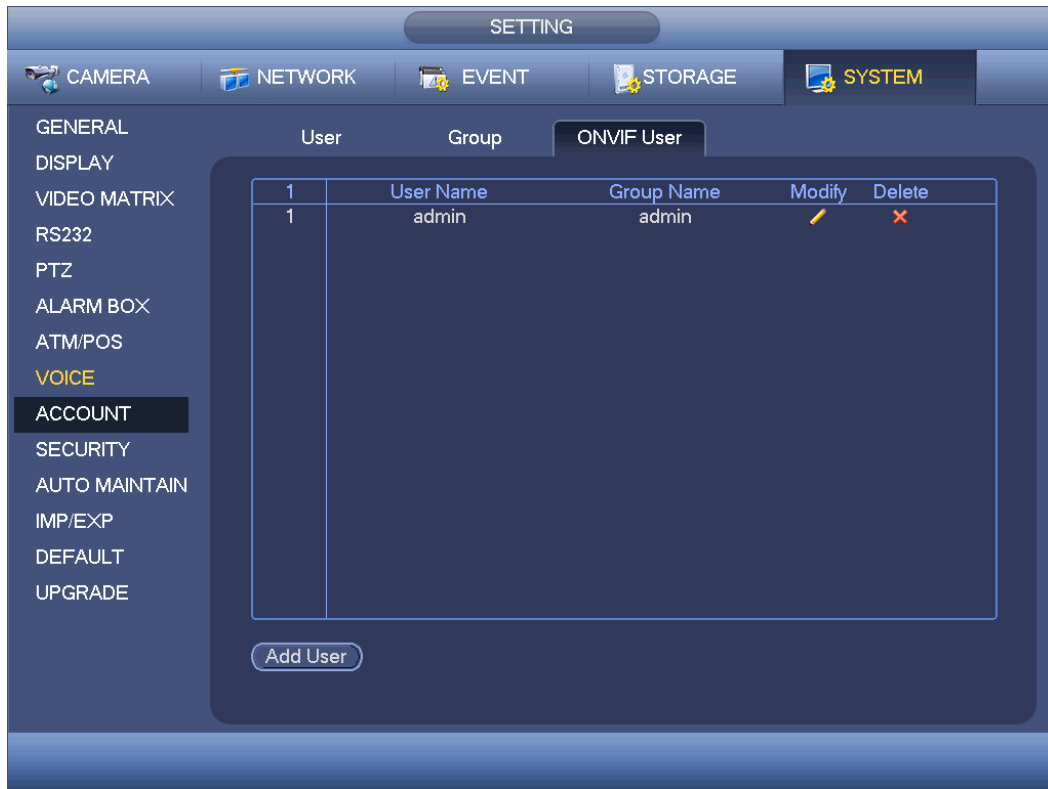

Figure 4-226

- Step 2 Click Add user button.
 Enter Add user interface. See Figure 4-227.



Figure 4-227

- Step 3 Set user name, password and then select group from the dropdown list.
 Step 4 Click Save to complete setup.

Note

Click  to change user information, click  to delete current user.

4.9.5.10 Security

4.9.5.10.1 Access Right

To enhance device network security and protect device data, please set the access right of the IP host (IP host here refers to the IP PC or the server). After you enabled trusted sites function, only the IP listed below can access current DVR.

If you enable blocked sites function, the following listed IP addresses cannot access current DVR.

Step 1 From main menu->Setting->System->Security->Access right.

Enter security interface. See Figure 4-228.

Step 2 Check the Enable box.

Select trusted sites/block sites.

- Enable trusted site function and then add the whitelist.
- Enable blocked site function and then add the blacklist.

Step 3 Set parameters.

- Start address/end address: Select one type from the dropdown list, you can input IP address in the start address and end address. Now you can click Add IP address or Add IP section to add. System supports max 64 IP addresses.
 - a) For the newly added IP address, it is in enable status by default. Remove the before the item, and then current item is not in the list.
 - b) System max supports 64 items.
 - c) Address column supports IPv4 or IPv6 format. If it is IPv6 address, system can optimize it. For example, system can optimize aa:0000: 00: 00aa: 00aa: 00aa: 00aa: 00aa as aa:: aa: aa: aa: aa: aa: aa.
 - d) System automatically removes space if there is any space before or after the newly added IP address.
 - e) System only checks start address if you add IP address. System check start address and end address if you add IP section and the end address shall be larger than the start address.
 - f) System may check newly added IP address exists or not. System does not add if input IP address does not exist.
 - Delete: Click it to remove specified item.
 - Edit: Click it to edit start address and end address. See Figure 4-229. System can check the IP address validity after the edit operation and implement IPv6 optimization.
 - Default: Click it to restore default setup. In this case, the trusted sites and blocked sites are both null.
- Step 4 Click Apply or Save to complete setup.
- If you enabled trusted sites, only the IP in the trusted sites list can access the device.
 - If you enabled blocked sites, the IP in the blocked sites cannot access the device.

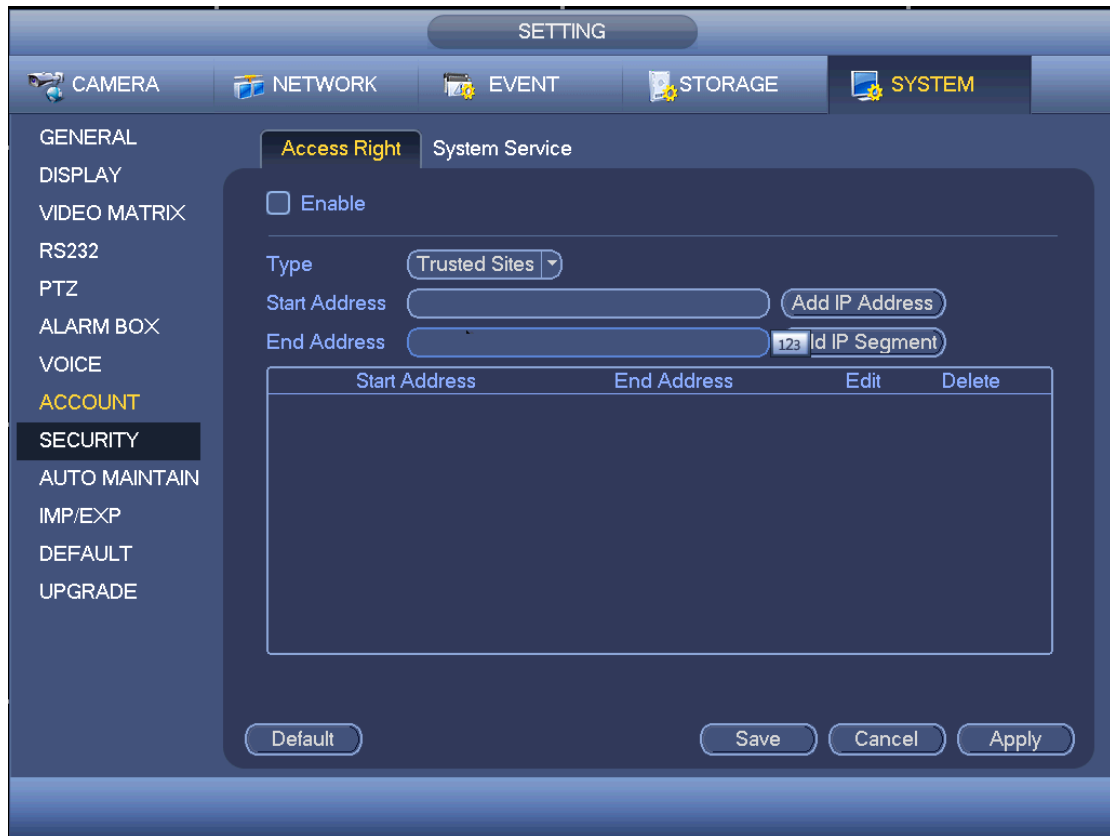

Figure 4-228

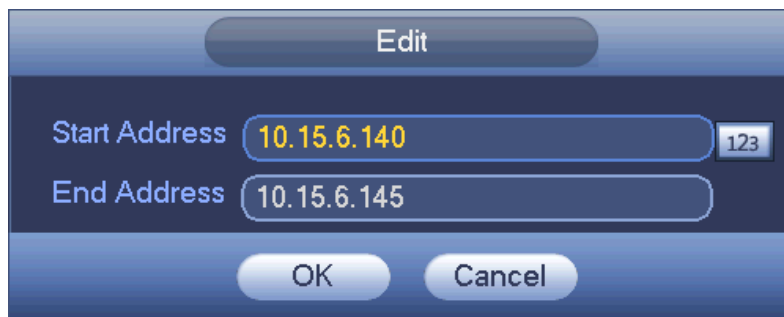

Figure 4-229

4.9.5.10.2 System Service

It is to enable/disable system service.

Step 1 From main menu->Setting->System->Security->System Service.

Enter system service interface. See Figure 4-230.

Step 2 Set parameters.

- Password reset: It is to enable/disable password reset function. You can only go to the local menu to answer the security questions to reset password if this function is disabled.

Note

This function is enabled by default.

Mobile phone push: The alarm triggered snapshot image can push to the mobile phone if this function is enabled.

 **Note**

This function is enabled by default.

- CGI: Front-end device can use CGI protocol to connect to the device.

 **Note**

This function is enabled by default.

- ONVIF: Front-end device can use ONVIF protocol to connect to the device.

 **Note**

This function is enabled by default.

- Audio/video transmission encryption: The audio/video transmission is encrypted if this function is enabled. Make sure the corresponding device or software supports video decryption function.



Figure 4-230

Step 3 Click Save or Apply.

4.9.5.11 Auto Maintain

It is to set auto-reboot time during the spare period if the device is running for a long time. It is to enhance device operation speed. Or you can set fan running mode. It is to reduce the noise and enhance fan lifecycle. See Figure 4-231.

After all the setups please click save button. .

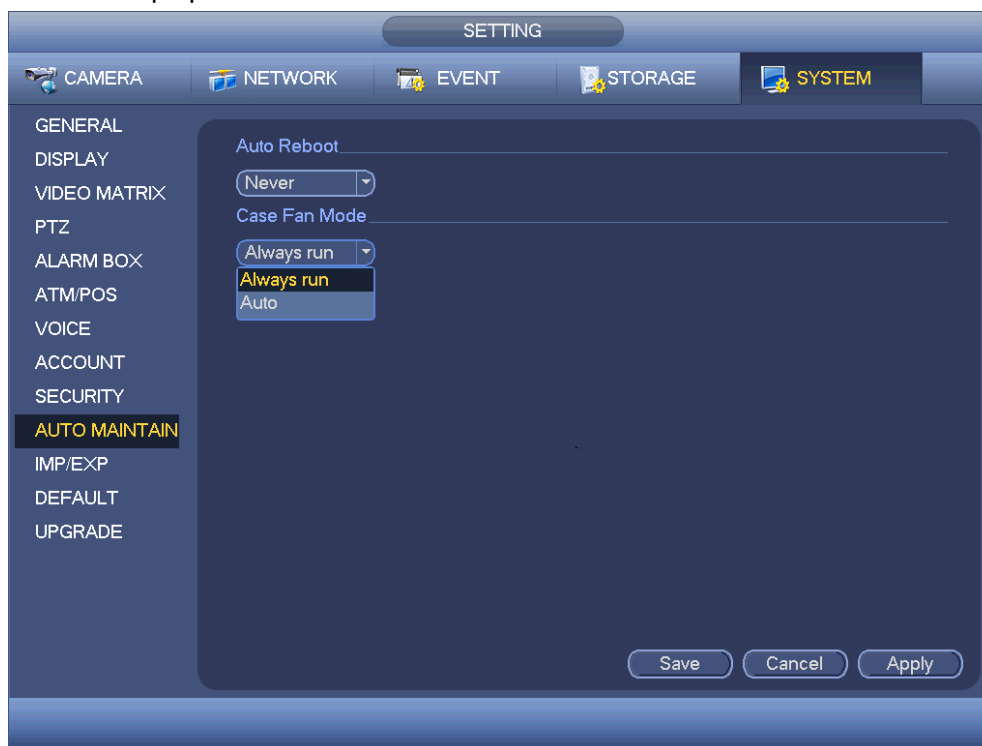

Figure 4-231

4.9.5.12 Import/Export

The configuration file backup interface is shown as below. See Figure 4-232.

This function allows you to import/export system configuration. You can use this function when there are several devices need the same setup.

- Export: Please connect the peripheral device first and then go to the following interface. Click Export button, you can see there is a corresponding "Config_Time" folder. Double click the folder, you can view some backup files.
- Import: Here you can import the configuration files from the peripheral device to current device. You need to select a folder first. You can see a dialogue box asking you to select a folder if you are selecting a file. System pops up a dialogue box if there is no configuration file under current folder. After successfully import, system needs to reboot to activate new setup.
- Format: Click Format button, system pops up a dialogue box for you to confirm current operation. System begins format process after you click the OK button.



Note:

- System cannot open config backup interface again if there is backup operation in the process.
- System refreshes device when you go to the config backup every time and set current directory as the root directory of the peripheral device.
- If you go to the configuration backup interface first and then insert the peripheral device, please click Refresh button to view the newly added device.

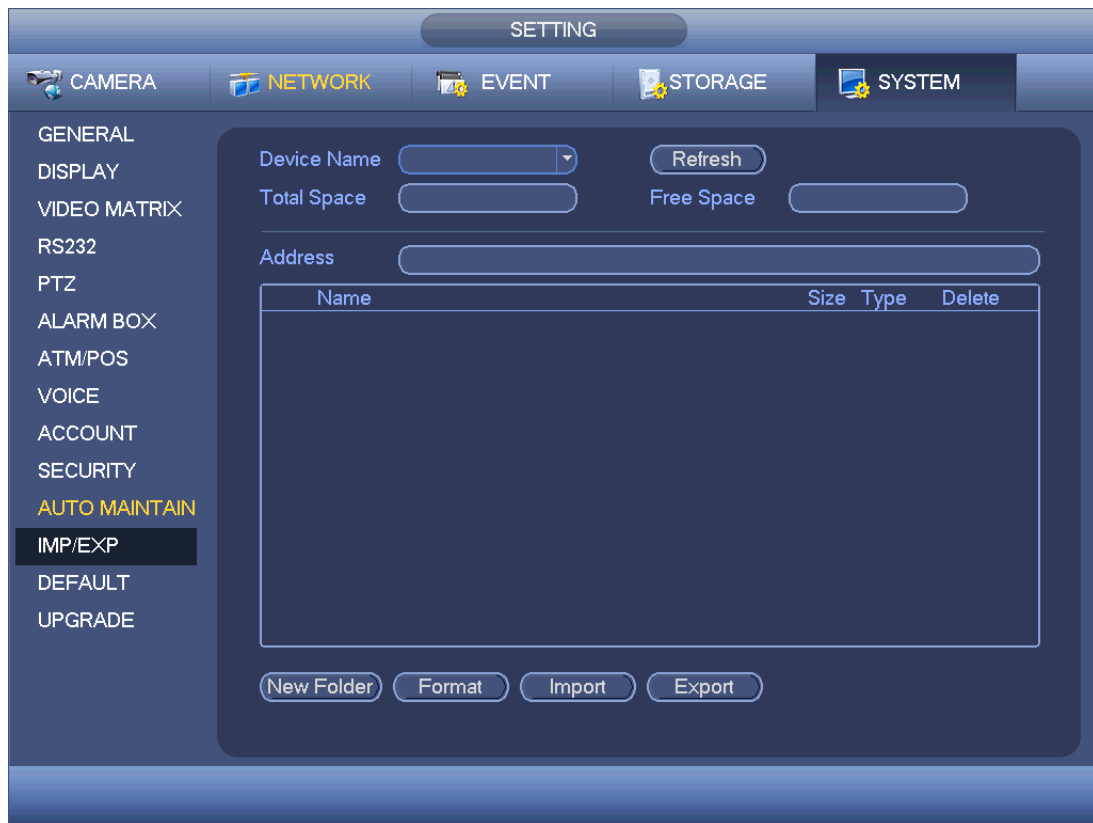



Figure 4-232

4.9.5.13 Default

Click default icon, system pops up a dialogue box. You can highlight  to restore default factory setup. See Figure 4-233.

- Camera
- Network
- Event
- Storage
- System

Please highlight icon  to select the corresponding function. Click Apply or Save to set. Click factory default button, you can restore factory default setup.



CAUTION

System menu color, language, time display mode, video format, IP address, user account will not maintain previous setup after default operation!



Figure 4-233

4.9.5.14 System Upgrade

4.9.5.14.1 GUI Upgrade

Please insert the USB device (make sure it contains the update file) to the device. Select System upgrade button to browse the update file. Click Start, system begins the upgrade. See Figure 4-234.



Figure 4-234

4.9.5.14.2 Online Upgrade

When the DVR is online, you can use the online upgrade to update the firmware.

Note

Make sure the DVR has properly connected to the network.

Version Detection

The version detection includes auto detection and manual detection. It displays current system version and application released date.

- Enable auto detection, DVR interactive with the cloud to detect there is new version available or not.
- Click manual detection, it is to view the latest new version on the cloud.
 - ✧ If current version is the latest one, there is prompt “It is the latest version”.
 - ✧ If DVR detects there is new version available, system displays new version information such as released date and corresponding release note.

Upgrade System



CAUTION

During the upgrade process, make sure the network connection and power supplying are

both OK.

Click Start to upgrade system.

4.9.5.14.3 Uboot

When DVR boots up, during the uboot process, DVR automatically detects there is USB device and there is upgrade file on the USB device or not. If the detection result is OK, DVR automatically begins upgrade.



CAUTION

- The USB device shall contain two files: u-boot.bin.img and update.img.
- The USB device shall connected to the USB port at the front panel. Otherwise, DVR cannot properly detect the file or upgrade.

5 WEB OPERATION



Note

Slightly difference may be found in the interface due to different series.

5.1 Network Connection

Before web client operation, please check the following items:

Step 1 Network connection is right

Step 2 DVR and PC network setup is right. Please refer to Chapter 5.10.2 Network (main menu->Setting->Network)

Step 3 Use order ping `***.***.***.***`(* is DVR IP address) to check connection is OK or not. Usually the return TTL value should be less than 255.



Note

- Device default IP address is 192.168.1.108.
- Current series product supports various browsers such as Safari, fire fox browser, Google browser. Device supports multiple-channel monitor, PTZ control, DVR parameter setup on the Apple PC.

5.2 Device Initialization

If it is your first time to use the device, please set a login password of **admin** (system default user).



Note

For your device safety, please keep your login password of **admin** well after the initialization steps, and change the password regularly.

Steps:

Step 1 Open the browser and then input the device IP address in the address column.

Step 2 Click Enter button.

Device displays device initialization interface. See Figure 5-1.

Device Initialization

1 Enter Password 2 Password Protection 3 Successful

Username admin

New Password

Low Middle High

It is 8 to 32-digit containing letter(s), number (s),symbol(s). It contains at least two types.

Confirm Password

Next

Figure 5-1

Step 3 Set login password of **admin**.

- User name: The default user name is **admin**.
- Password/confirm password: The password ranges from 8 to 32 digitals. It can contain letters, numbers and special characters (excluding “”, “”, “;”, “.”, “&”) . The password shall contain at least two categories. Usually we recommend the strong password.



WARNING

STRONG PASSWORD RECOMMENDED-For your device own safety, please create a strong password of your own choosing. We also recommend you change your password periodically especially in the high security system.

Step 4 Click Next, device goes to the following interface. See Figure 5-2.

Figure 5-2

Step 5 Set security questions.

 **Note**

- After setting the security questions here, you can use the email you input here or answer the security questions to reset **admin** password Refer to chapter 5.4 Reset password for detailed information.
- Cancel the email or security questions box and then click Next button to skip this step.
- Email: Input an email address for reset password purpose. Scan the QR code to reset the password, you need to receive the security code by the email. Input the security code to reset the password of **admin**. In case you have not input email address here or you need to update the email information, please go to the main interface->System->Account to set. Refer to chapter 5.10.5.9 Account for detailed information.
- Security question: Set security questions and corresponding answers. Properly answer the questions to reset **admin** password. In case you have not input security question here or you need to update the security question information, please go to the local main interface->Setting->System->Account->Security question to set. Refer to chapter 5.10.5.9 Account for detailed information.

 **Note**

If you want to reset password by answering security questions, please go to the local menu interface.

Step 6 Click OK to complete the device initialization setup. See Figure 5-3.

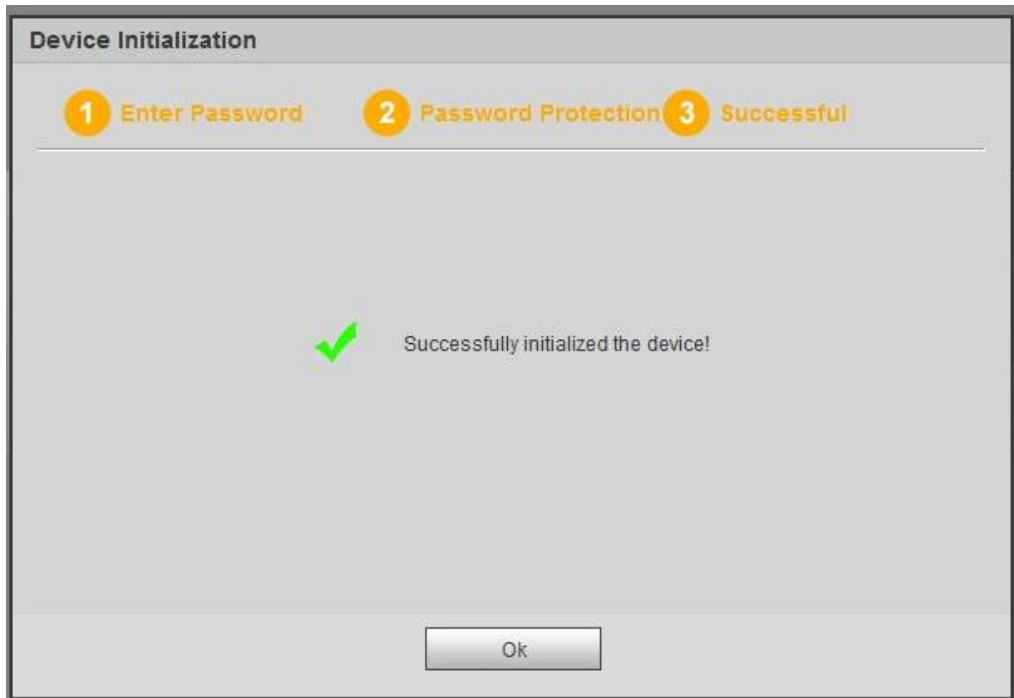

Figure 5-3

5.3 Login

Step 1 Open IE and input DVR address in the address column.

System pops up warning information to ask you whether install control or not. See Figure 5-4.

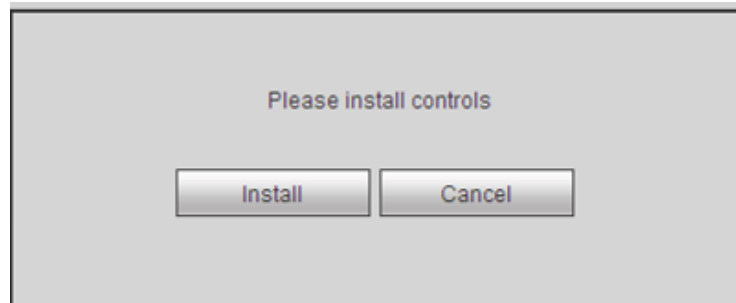

Figure 5-4

Step 2 Please click Install button, system can auto run the installation. Or follow the prompts to save the installation package and install. After installation, the interface is shown as below. See Figure 5-5.

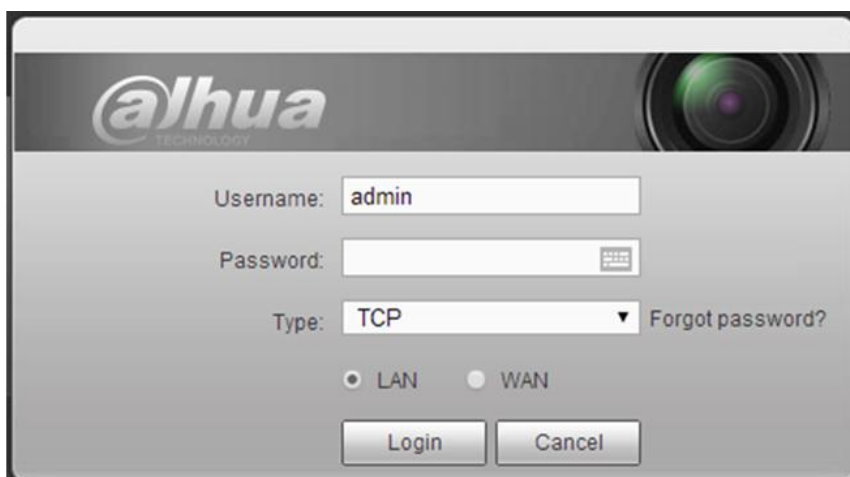

Figure 5-5

Step 3 Please input user name and password.

 **Note**

- Device factory default user name is **admin**. The password is that you set during initialization process. For your device safety, please change the admin password regularly and keep it well.
- Check the Plain text to view the input password.
- In case you forgot password, click Forgot password to reset. Refer to chapter 5.4 Reset password for detailed information.
- There are two login types: LAN/WAN. For the difference of these two modes, please refer to chapter 5.9 WAN login.

Step 4 Click Login.

Enter the preview interface.

 **Note**

Delete old plug-in when you want to upgrade new version. Go to C:\Program Files (x86)\webrec\WEB30\Webview_H" and run uninstallation tool uninst.exe, device automatically deletes the old plug-in.

5.4 Reset Password

If you forgot **admin** login password, there are two ways for you to reset password.

- When password reset function is enabled, scan the QR code on the user interface and use the e-mail to reset password.
- When the password reset function is disabled, answer the security questions to reset password. If you have not set security questions, system pops up "Password reset function has been disabled" dialogue box. There are two ways to reset password:
 - ✧ Use an account of admin group to login WEB and then enable password reset function. Refer to chapter 5.10.5.14.2 System service for detailed information.
 - ✧ If there is no account of admin group, go to the local menu to reset password. Refer to chapter 4.1.3 Reset password for detailed information.

Steps:

Step 1 Open browser and go to the device login interface. See Figure 5-3.



Figure 5-6

Step 2 Click Forgot password, enter the following interface. See Figure 5-7.

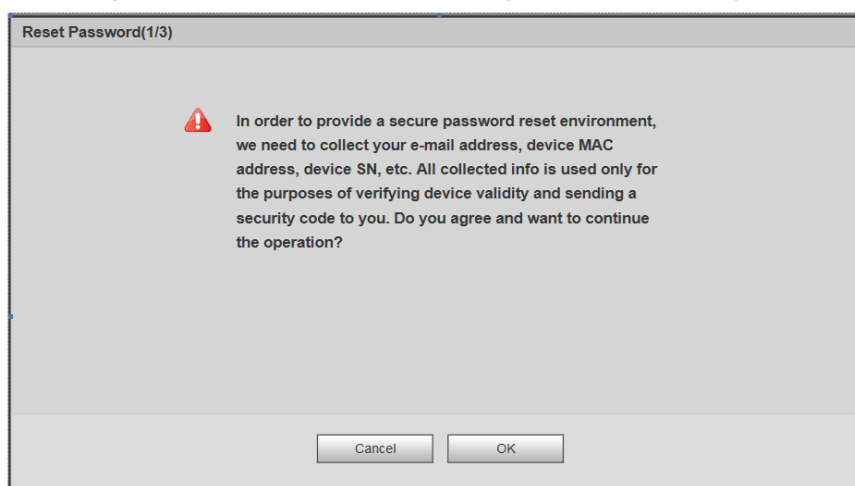

Figure 5-7

Step 3 Click OK.

System pops up reset password interface. See Figure 5-8.

Note

Click OK we are going to collect your information for reset password purpose. The collected information includes but not limited to your cellphone number, device MAC address, device SN. Please read the the notice carefully and make sure you agree to our information collection operation.

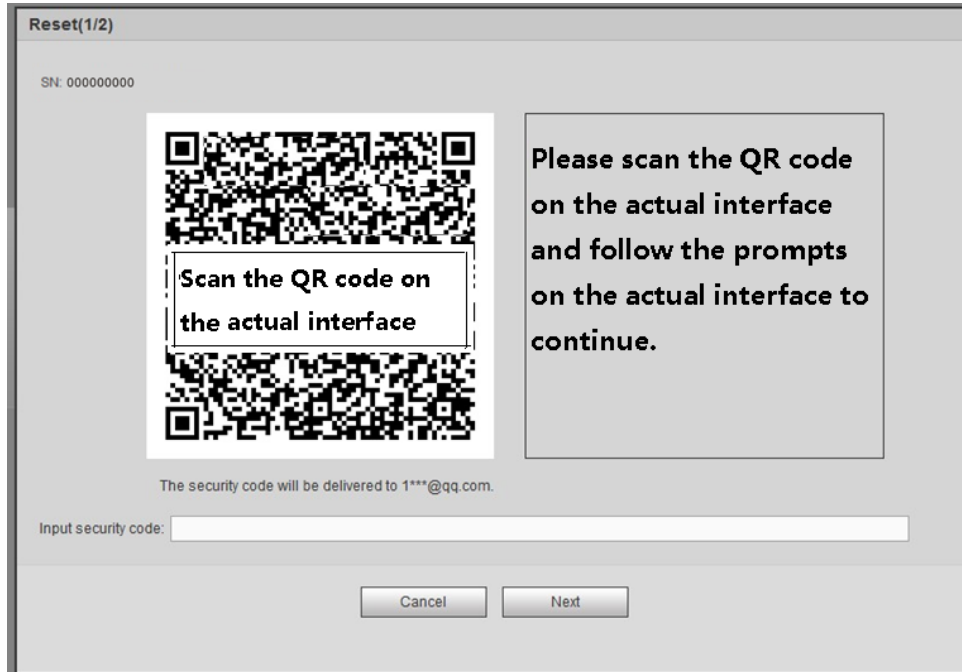

Figure 5-8

Step 4 Follow the prompts on the interface and then scan the QR code to get the security code.



WARNING

- ✧ For the same QR code, max scan twice to get two security codes. Refresh the QR code if you want to get security code again.
- ✧ The security code on you email is only valid for 24 hours.
- ✧ After five times security code failure, the **admin** account will be locked for 5 minutes.

Step 5 Input the security code on the email and then click Next button.

Step 6 Input new password and then confirm.



WARNING

STRONG PASSWORD RECOMMENDED-For your device own safety, please create a strong password of your own choosing. The password shall be at least 8-digit containing at least two types of the following categories: letters, numbers and symbols. We also recommend you change your password periodically especially in the high security system.

Step 7 Click OK button to complete the setup.

5.5 LAN Mode

For the LAN mode, after you logged in, you can see the main window. See Figure 5-9.

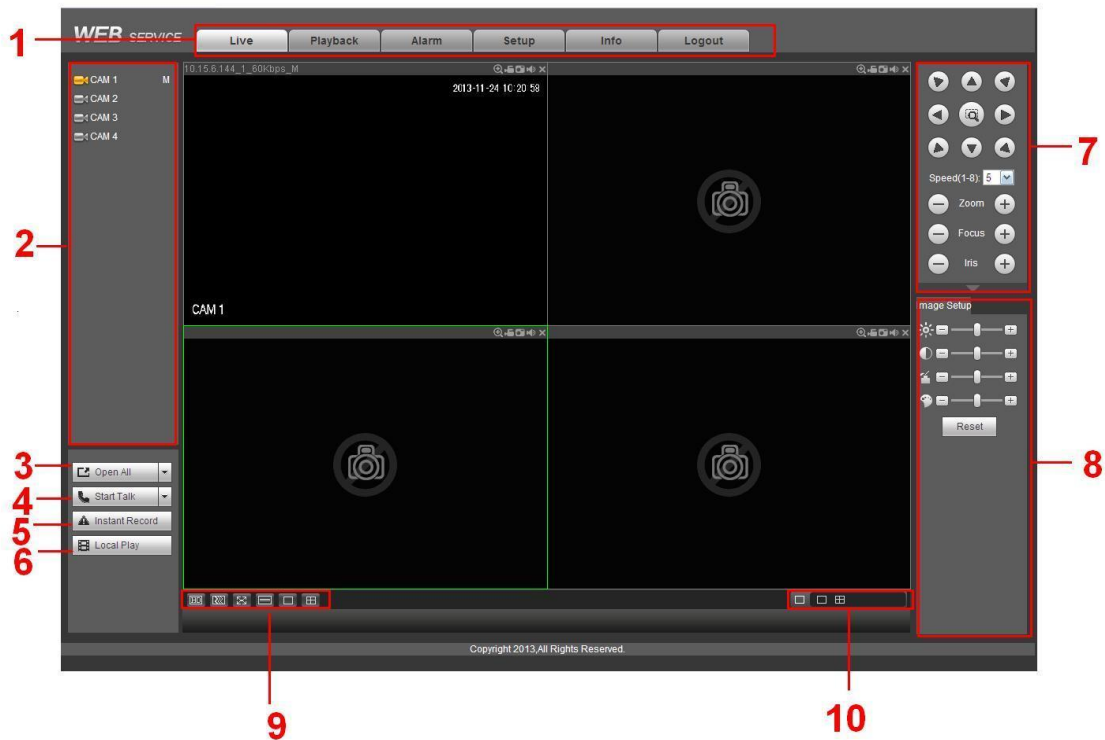

Figure 5-9

This main window can be divided into the following sections.

- Section 1: there are five function buttons: Live (chapter 5.6) , setup (chapter 5.10), search (chapter 5.12), alarm (chapter 5.13), face search (chapter 5.13)and logout (chapter 5.15).
- Section 2: There are channel number and one button: Start all. Start all button is to enable/disable all-channel real-time monitor. Click it the button becomes yellow. See Figure 5-10.

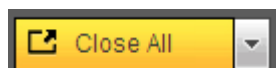

Figure 5-10

Please refer to Figure 5-11 for main stream and extra stream switch information.

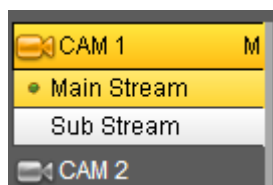

Figure 5-11

- Section 3: Start dialogue button.
 You can click this button to enable audio talk. Click 【▼】 to select bidirectional talk mode. There are four options: DEFAULT,G711a,G711u and PCM. After you enable the bidirectional talk, the Start talk button becomes End Talk button and it becomes yellow.

See Figure 5-12.

Please note, if audio input port from the device to the client-end is using the first channel audio input port. During the bidirectional talk process, system will not encode the audio data from the 1-channel.

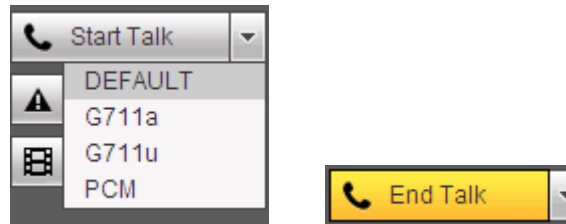

Figure 5-12

- Section 4: Instant record button. Click it, the button becomes yellow and system begins manual record. See Figure 5-13. Click it again, system restores previous record mode..



Figure 5-13

- Section 5: Local play button.

The Web can playback the saved (Extension name is dav) files in the PC-end.

Click local play button, system pops up the following interface for you to select local play file. See Figure 5-14.



Figure 5-14

- Section 6: From the left to the right ,you can see video quality/fluency/ full screen/1-window/4-window/6-window/8-window/9-window/13-window/16-window/20-window/25-window/36-window.. You can set video fluency and real-time feature priority.
- Section 7: PTZ operation panel. Please refer to chapter 5.7 for detailed information.
- Section 8: Image setup and alarm setup. Please refer to chapter 5.8 for detailed information.
- Section 9:From left to right, it is to set video quality, video latency, full screen, 1-window, 4-window.

- Section 10:Zero-channel encoding. This function allows you to view several-channel in one window. It supports 1/4-channel mode. Please go to chapter 4.9.5.2.4 to enable zero-channel encoding function first.

5.6 Real-time Monitor

In section 2, left click the channel name you want to view, you can see the corresponding video in current window.

On the top left corner, you can view device IP, channel number, network monitor bit stream. See Figure 5-15.

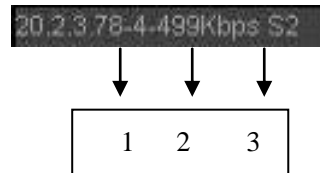

Figure 5-15

On the top right corner, there are six unction buttons. See Figure 5-16.

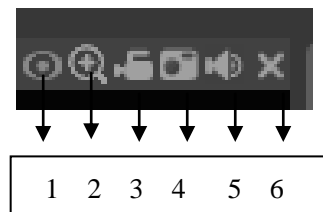

Figure 5-16

- 1: Fisheye: Click to adjust fisheye installation mode and display mode. See Figure 5-17. Please note this function is for some series only.
- 2: Digital zoom: Click this button and then left drag the mouse in the zone to zoom in. right click mouse system restores original status.
- 3: Local record. When you click local record button, the system begins recording and this button becomes highlighted. You can go to system folder RecordDownload to view the recorded file.
- 4: Snapshot picture. You can snapshot important video. All images are memorized in system client folder PictureDownload (default).
- 5: Audio :Turn on or off audio.(It has no relationship with system audio setup)
- 6: Close video.

5.6.1 Fisheye de-warp















Fisheye de-warp interface is shown as in Figure 5-17.



Figure 5-17

There are three installation modes: ceiling mount/wall mount/ground mount. The different installations modes have different de-warp modes.

Please refer to the following sheet for detailed information.

Installation modes	Icon	Note
 (Ceiling mount)  (Ground mount)		360°panorama original view
		1 de-warp window+1 panorama stretching
		2 panorama stretching view
		1 360° panorama view+3 de-warp windows
		1 360°panorama view+4 de-warp windows
		6 de-warp windows+1 panorama stretching
		1 360° panorama view+8 de-warp windows
 (Wall mount)		360°panorama original view
		Panorama stretching
		1 panorama unfolding view+3 de-warp windows
		1 panorama unfolding view +4 de warp windows

Installation modes	Icon	Note
		1 panorama unfolding view +8 de warp windows

In Figure 5-18, there are one ceiling mount 360°panorama view + four de-warp windows. You can adjust the color pane on the left pane or use your mouse to change the position of the small images on the right pane to realize fish eye de-warp. Please use mouse to zoom in/out, move, rotate and so on to adjust.



Figure 5-18

5.7 PTZ

Before PTZ operation, please make sure you have properly set PTZ protocol. (Please refer to chapter 5.10.5.5).

There are eight direction keys. In the middle of the eight direction keys, there is a 3D intelligent positioning key.

Click 3D intelligent positioning key, system goes back to the single screen mode. Drag the mouse in the screen to adjust section size. It can realize PTZ automatically.

Please refer to the following sheet for PTZ setup information.

Parameter	Function
Scan	<ul style="list-style-type: none"> ● Select Scan from the dropdown list. ● Click Set button, you can set scan left and right limit. ● Use direction buttons to move the camera to you desired location and then click left limit button. Then move the camera again and then click right limit button to set a right limit.
Preset	<ul style="list-style-type: none"> ● Select Preset from the dropdown list. ● Turn the camera to the corresponding position and Input the preset value. Click Add button to add a preset.

Parameter	Function
Tour	<ul style="list-style-type: none"> ● Select Tour from the dropdown list. ● Input preset value in the column. Click Add preset button, you have added one preset in the tour. ● Repeat the above procedures you can add more presets in one tour. ● Or you can click delete preset button to remove one preset from the tour.
Pattern	<ul style="list-style-type: none"> ● Select Pattern from the dropdown list. ● You can input pattern value and then click Start button to begin PTZ movement such as zoom, focus, iris, direction and etc. Then you can click Add button to set one pattern.
Aux	<ul style="list-style-type: none"> ● Please input the corresponding aux value here. ● You can select one option and then click AUX on or AUX off button.
Light and wiper	You can turn on or turn off the light/wiper.

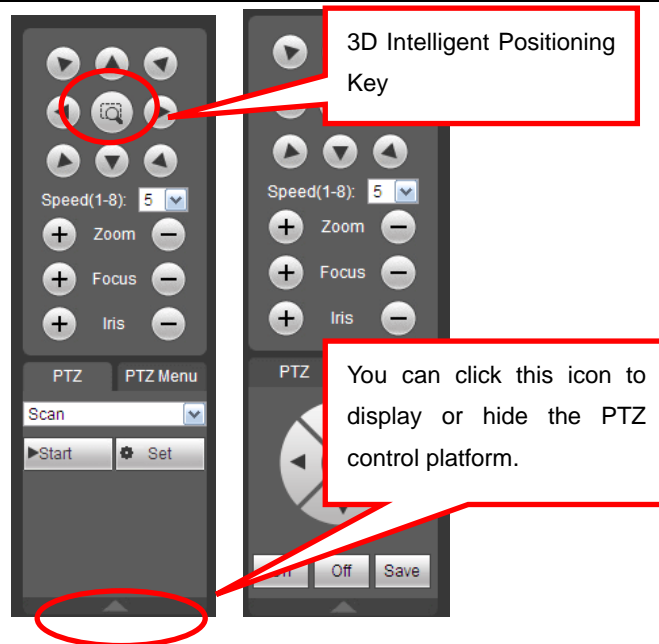

Figure 5-19

5.8 Image/Relay-out

Select one monitor channel video and then click Image button in section 8, the interface is shown as Figure 5-20.

5.8.1 Image

Here you can adjust its brightness, contrast, hue and saturation. (Current channel border becomes green).

Or you can click Reset button to restore system default setup.



Figure 5-20

5.8.2 Relay output

Here you can enable or disable the alarm signal of the corresponding port. See Figure 5-21.

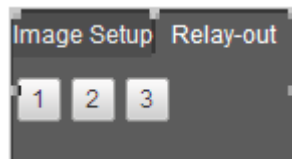

Figure 5-21

5.9 WAN Login

In WAN mode, after you logged in, the interface is shown as below. See Figure 5-22.

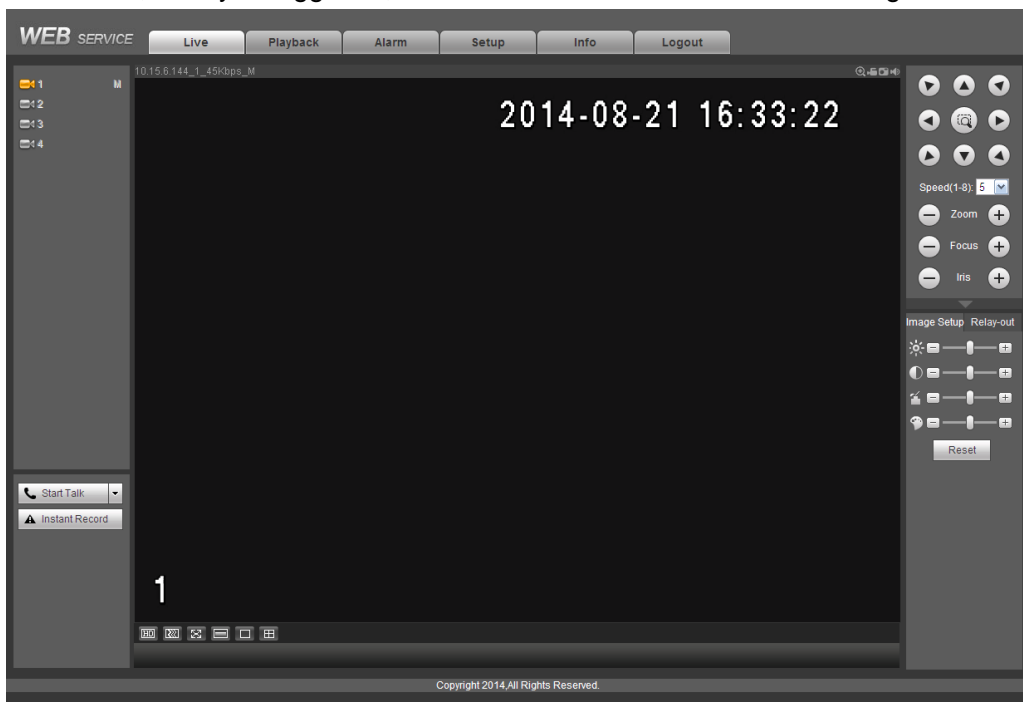

Figure 5-22

Please refer to the following contents for LAN and WAN login difference.

- 1) In the WAN mode, system opens the main stream of the first channel to monitor by default. The open/close button on the left pane is null.

2) You can select different channels and different monitor modes at the bottom of the interface.

Important

The window display mode and the channel number are by default. For example, for the 16-channel, the max window split mode is 16.

3) Multiple-channel monitor, system adopts extra stream to monitor by default. Double click one channel, system switches to single channel and system uses main stream to monitor. You can view there are two icons at the left top corner of the channel number for you reference. M stands for main stream. S stands for sub stream (extra stream).

4) If you login via the WAN mode, system does not support alarm activation to open the video function in the Alarm setup interface.

 **Note**

- For multiple-channel monitor mode, system adopts extra stream to monitor by default. You cannot modify manually. All channels are trying to synchronize. Please note the synchronization effect still depends on your network environments.
- For bandwidth consideration, system cannot support monitor and playback at the same time. System auto closes monitor or playback interface when you are searching setup in the configuration interface. It is to enhance search speed.

5.10 Setup

Here is to introduce DVR basic setups and system configurations.

5.10.1 Camera

It is to add network camera, set camera properties and set encode parameters.

5.10.1.1 Remote Device (For digital channel only)

From main window->Setup->Camera->Registration, registration interface is shown as below. See Figure 5-23.

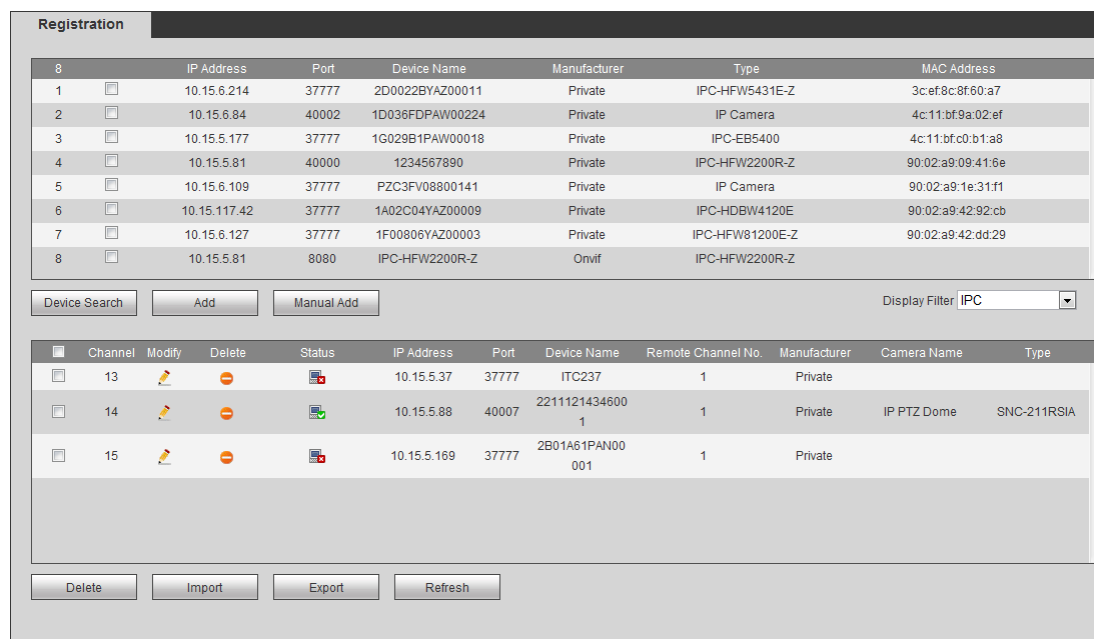

The screenshot shows the 'Registration' interface with two main tables. The top table lists registered devices with columns for Channel, IP Address, Port, Device Name, Manufacturer, Type, and MAC Address. The bottom table lists channels with columns for Channel, Modify, Delete, Status, IP Address, Port, Device Name, Remote Channel No., Manufacturer, Camera Name, and Type. Below the tables are buttons for 'Device Search', 'Add', 'Manual Add', 'Delete', 'Import', 'Export', and 'Refresh', along with a 'Display Filter' dropdown set to 'IPC'.

Channel	IP Address	Port	Device Name	Manufacturer	Type	MAC Address
1	10.15.6.214	37777	2D0022BYAZ00011	Private	IPC-HFW5431E-Z	3cef8c8f60a7
2	10.15.6.84	40002	1D038FDPAW00224	Private	IP Camera	4c11bf9a02ef
3	10.15.5.177	37777	1G029B1PAW00018	Private	IPC-EB5400	4c11bfc0b1a8
4	10.15.5.81	40000	1234567890	Private	IPC-HFW2200R-Z	9002a909416e
5	10.15.6.109	37777	PZC3FV08800141	Private	IP Camera	9002a91e31f1
6	10.15.117.42	37777	1A02C04YAZ00009	Private	IPC-HDBW4120E	9002a94292cb
7	10.15.6.127	37777	1F00806YAZ00003	Private	IPC-HFW81200E-Z	9002a942dd29
8	10.15.5.81	8080	IPC-HFW2200R-Z	Onvif	IPC-HFW2200R-Z	

Channel	Modify	Delete	Status	IP Address	Port	Device Name	Remote Channel No.	Manufacturer	Camera Name	Type
13				10.15.5.37	37777	ITC237	1	Private		
14				10.15.5.88	40007	22111214346001	1	Private	IP PTZ Dome	SNC-211RSA
15				10.15.5.169	37777	2B01A61PAN00001	1	Private		

Figure 5-23

5.10.1.1.1 Initialize Camera

It is to initialize connected remote device and change its login password and IP address.

Steps:

Step 1 From main interface->Setting->Camera->Registration.

Enter Registration interface. See Figure 5-24.

Step 2 Click IP search and check the Uninitialized box.

Device displays uninitialized camera.

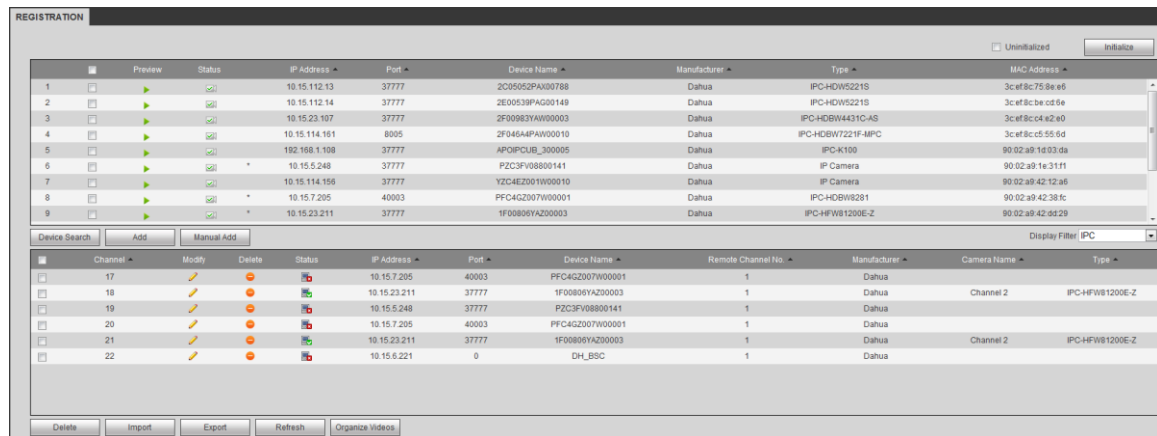

Figure 5-24

Step 3 Select a camera to be initialized and then click Initialize button.

Device displays password setup interface. See Figure 5-25.

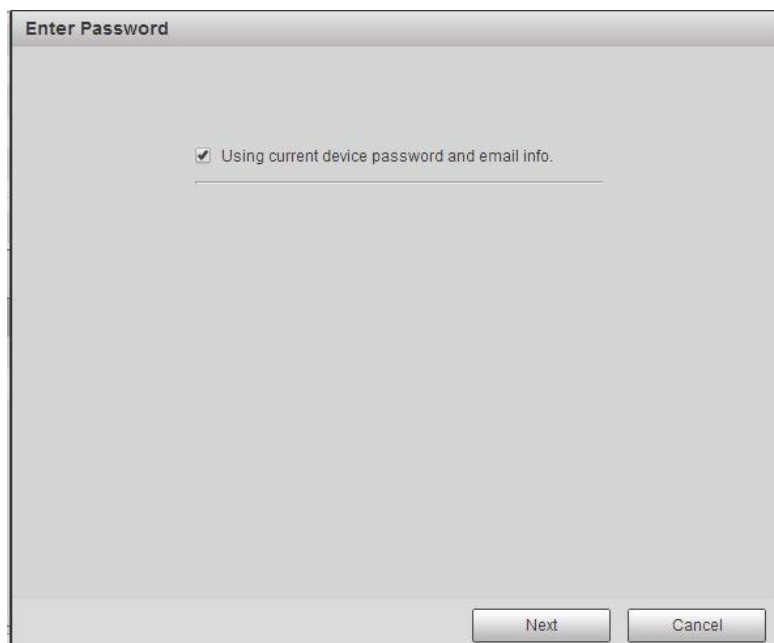

Figure 5-25

Step 4 Set camera password.

- Using current device password and email: Check the box to use DVR

current admin account and email information. There is no need to set password and email. Please go to step 7.

- User name/password: The user name is **admin**. The password ranges from 8 to 32 digitals. It can contain letters, numbers and special characters (excluding “”, “()”, “;”, “:”, “&”). The password shall contain at least two categories. Usually we recommend the strong password.



WARNING

STRONG PASSWORD RECOMMENDED-For your device own safety, please create a strong password of your own choosing. We also recommend you change your password periodically especially in the high security system.

Step 5 Click Next button.

Enter input email interface. See Figure 5-26.

Email: Input an email address for reset password purpose.



Note

Cancel the box and then click Next or Skip if you do not want to input email information here.

Password Protection

Email Address To reset password, please input properly or update in time

Back Next Skip

Figure 5-26

Step 6 Click Next button.

Enter Modify IP address interface. See Figure 5-27.

NETWORK

Checked Device No.: 1

DHCP STATIC

IP Address Incremental Value

Subnet Mask

Default Gateway

No.	IP Address
1	172.8.7.110

Back Next Skip

Figure 5-27

Step 7 Set camera IP address.

- Check DHCP, there is no need to input IP address, subnet mask, and default gateway. Device automatically allocates the IP address to the camera.
- Check Static, and then input IP address, subnet mask, default gateway and incremental value.



Note

- If it is to change several devices IP addresses at the same time, please input incremental value. Device can add the fourth address of the IP address one by one to automatically allocate the IP addresses.
- If there is IP conflict when changing static IP address, device pops up IP conflict dialogue box. If batch change IP address, device automatically skips the conflicted IP and begin the allocation according to the incremental value

Step 8 Click Next button.

Device begins initializing camera. See Figure 5-28.

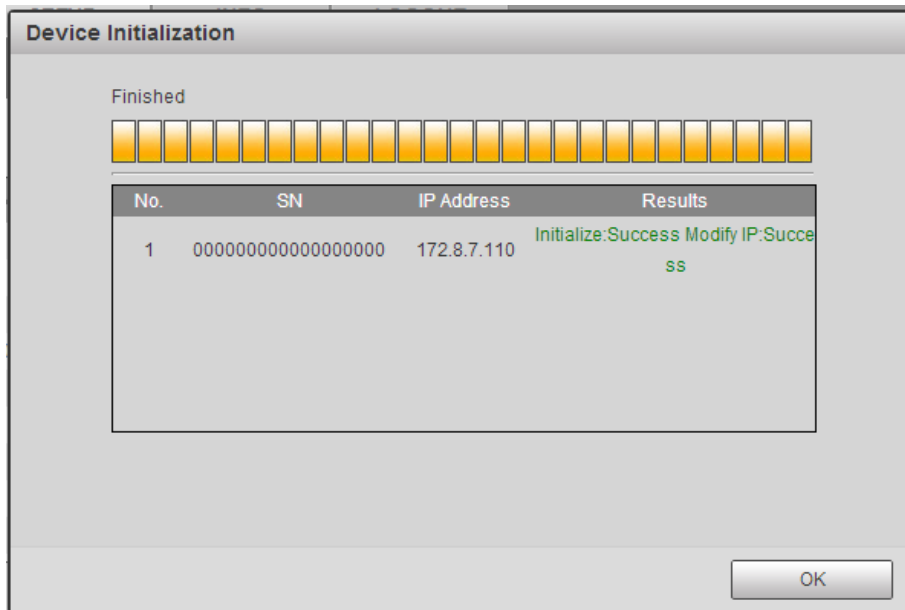

Figure 5-28

Step 9 Click OK to complete the initialization.

5.10.1.1.2 Auto Add

Step 1 From main interface->Setting->Camera->Registration

Step 2 Click IP Search, device displays searched results.

Step 3 Double click an IP address or select an IP address and then click Add button, it is to register the device to the DVR. Device supports batch add.

5.10.1.1.3 Manual Add

Step 1 Click Manual add to register the camera manually. There are three modes: TCP/UDP/Auto. The default setup is TCP. See Figure 5-29.

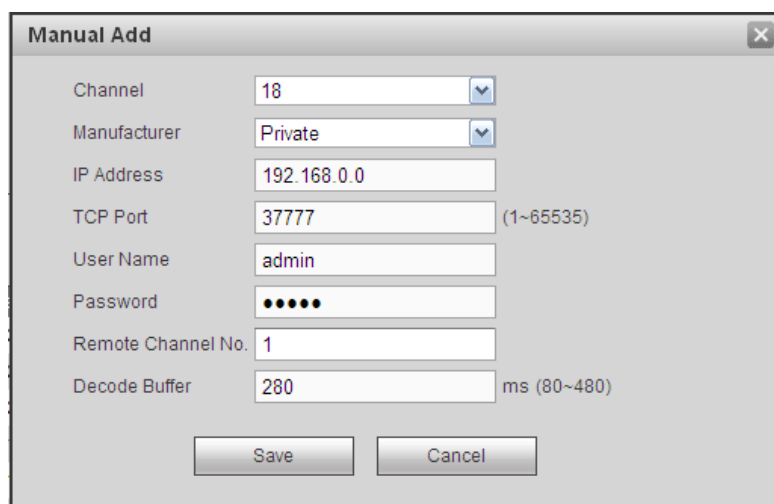







Figure 5-29

Step 2 Set parameters.



Parameter	Function
Manufacturer	<p>Please select from the dropdown list.</p> <p>System supports manufactures such as Panasonic, Sony, Dynacolor, Samsung, AXIS, Arecont, LG, Watchnet, PSIA, AirLive, Dahua and Onvif standard protocol.</p> <p> Note</p> <p>Different series products may support different manufacturers, please refer to the actual product.</p>
IP address	Input remote device IP address.
RTSP port	<p>Input RTSP port of the remote device. The default setup is 554.</p> <p> Note</p> <p>Skip this item if the manufacture is private or customize.</p>
HTTP port	<p>Input HTTP port of the remote device. The default setup is 80.</p> <p> Note</p> <p>Skip this item if the manufacture is private or customize.</p>
TCP port	Input TCP port of the remote device. The default setup is 37777.
User name/password	The user name and password to login the remote device.
Channel No.	<p>Input channel amount or click the Connect button to get the channel amount of the remote device.</p> <p> Note</p> <p>We recommend click Connect button to get remote device channel amount, the manual add operation may result in failure if the input channel amount is not right.</p>
Remote channel No.	<p>After getting the remote device channel amount, click Setup to select a channel.</p> <p> Note</p> <p>Click to select one or more remote channel numbers here.</p>
Channel	The local channel number you want to add. One channel name has corresponding one channel number.
Decode buffer	There are three item: realtime,local, fluent.
Service type	<p>There are four items: auto/TCP/UDP/MULTICAST(MULTICAST is for ONVIF device only)</p> <p> Note</p> <ul style="list-style-type: none"> The default connection mode is TCP if the connection protocol is private.

Parameter	Function
	<ul style="list-style-type: none"> There are four items: Auto/TCP/UDP/MULTICAST if the connection protocol is ONVIF. The transmission supports encryption mode. There are two items: TCP/UDP if the connection protocol is from the third-party.

Step 3 Click Save button.

The newly added device is added to the list at the bottom of the interface.

 **Note**

 means connection successful.  means connection failed.

5.10.1.1.4 Modify or Delete Device

- Click  or double click a device in the added list. Device pops up the following dialogue box. See Figure 5-30.

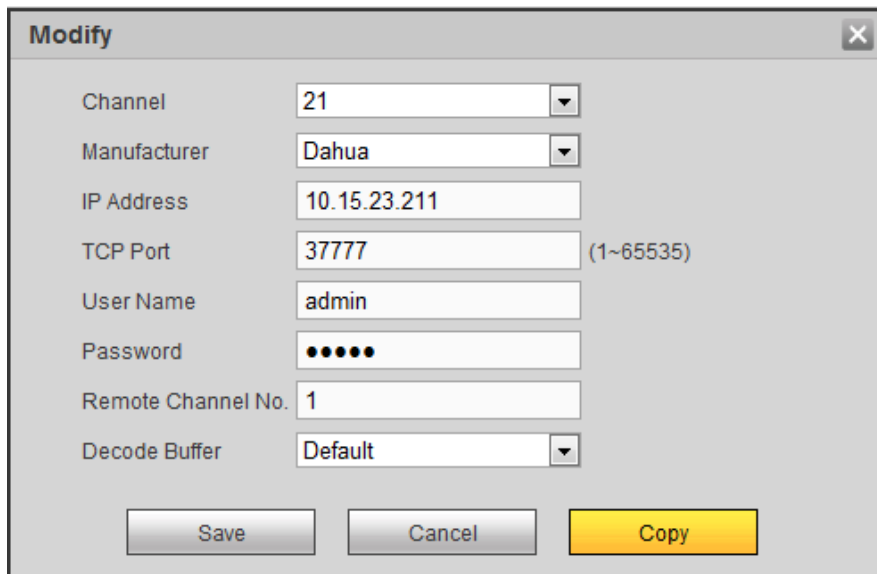

The image shows a 'Modify' dialog box with the following fields and values:

Channel	21
Manufacturer	Dahua
IP Address	10.15.23.211
TCP Port	37777 (1~65535)
User Name	admin
Password	•••••
Remote Channel No.	1
Decode Buffer	Default

At the bottom of the dialog box are three buttons: 'Save', 'Cancel', and 'Copy'.

Figure 5-30

- ◇ Select a channel from the dropdown list and change the parameters.
- ◇ Click Copy, device pops up the following dialogue box. It is to copy the user name and password to the selected channel(s). See Figure 4-31.

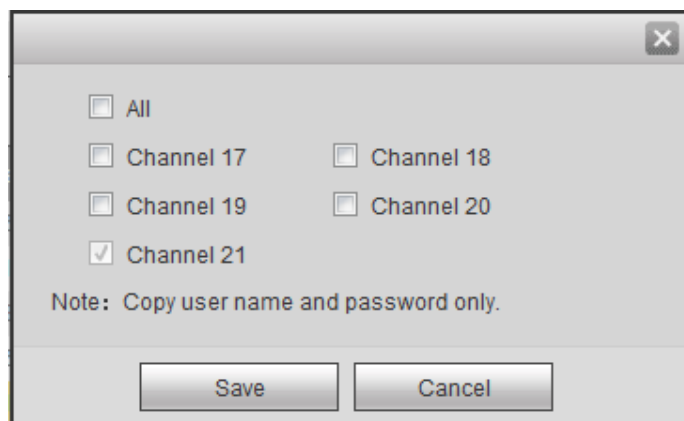



Figure 5-31

- Click  to disconnect the camera and remove it from the added list.
- Select one or several device(s) in the added list, click Delete button to delete. Check the box before the channel number to select all channels at the same time.

5.10.1.1.5 IP Export

System can export the Added device list to your local USB device.

Step 1 Insert the USB device and then click the Export button.

Enter the following interface.

Step 2 Select the directory and then click the OK button.

System pops up a dialogue box to remind you successfully exported.

Step 3 Please click OK button to exit.



Note

The exported file extension name is .CSV. The file information includes IP address, port, remote channel number, manufacturer, user name and password.

5.10.1.1.6 IP Import

Import IP address to add the camera.

Step 1 Click Import button.

Enter Browse interface.

Step 2 Select the import file and then click the OK button.

System pops up a dialogue box to remind you successfully exported.



Note

If the imported IP has conflicted with current added device, system pops up a dialogue box to remind you. You have two options:

- **OK:** Click OK button, system uses the imported setup to overlay current one.
- **Cancel:** Click Cancel button, system adds the new IP setup.

Step 3 Please click OK button to exit.



CAUTION

- You can edit the exported .CSV file. **Do not change the file format; otherwise it may result in import failure.**
- Does not support customized protocol import and export.
- The import and export device shall have the same language format.

5.10.1.2 Conditions

Here you can view device property information. The setups become valid immediately after you set.

The analog channel is shown as in Figure 5-32.

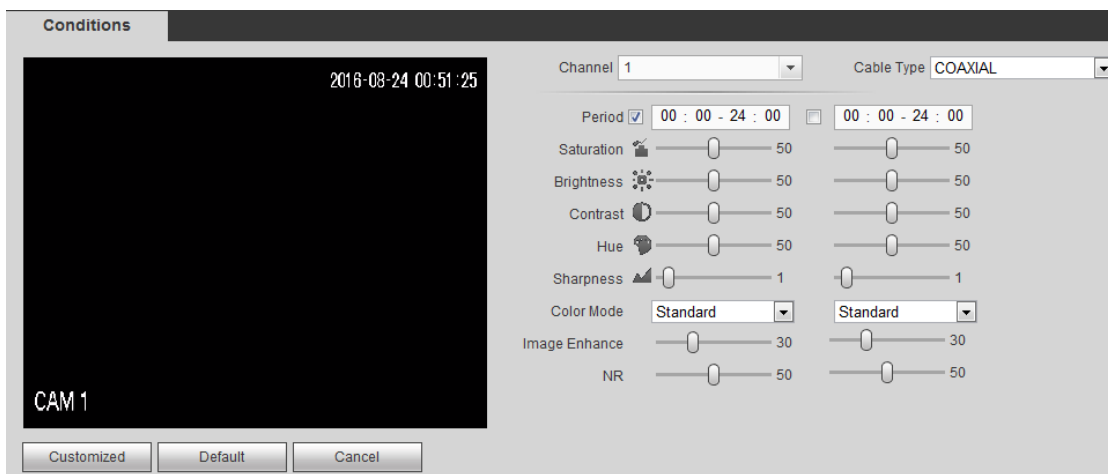

Figure 5-32

The digital channel is shown as in Figure 5-33.

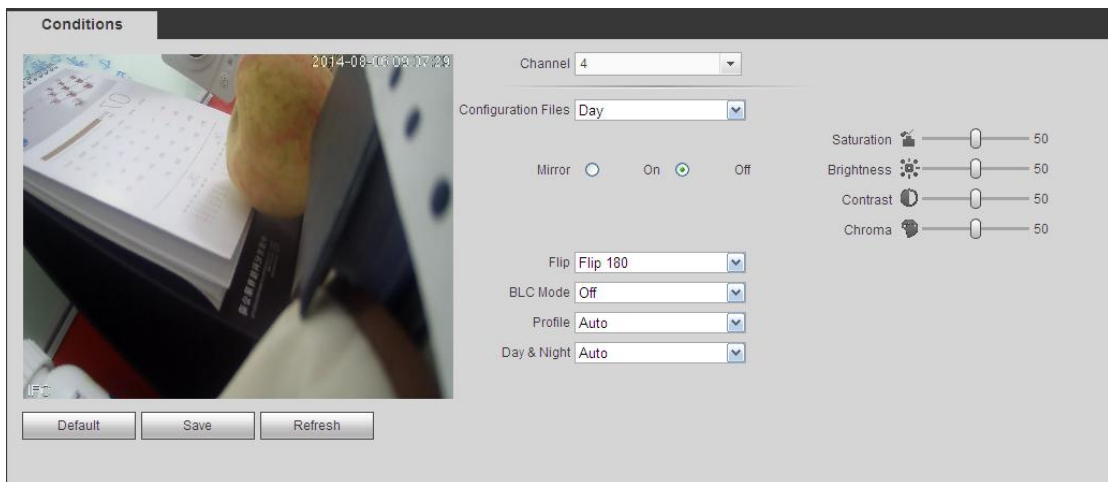

Figure 5-33

Please refer to the following sheet for detailed information.

Parameter	Function
Channel	Please select a channel from the dropdown list.

Parameter	Function
Cable type	<p>It is to set the cable type of the corresponding analog channel. When the setup here matches the actual cable you are using, you can get the best image effect. The default setup is COAXIAL. Please note this function is for some series product only.</p> <ul style="list-style-type: none"> ● COAXIAL: When the corresponding channel is using coaxial cable, please select COAXIAL. ● UTP: When the corresponding channel is using UTP cable, please select UTP. Usually we recommend 10Ohm UTP cable.
Period	<p>It divides one day (24 hours) to two periods. You can set different hue, brightness, and contrast for different periods.</p>
Hue	<p>It is to adjust monitor video brightness and darkness level. The default value is 50.</p> <p>The bigger the value is, the large the contrast between the bright and dark section is and vice versa.</p>
Brightness	<p>It is to adjust monitor window brightness. The default value is 50.</p> <p>The larger the number is, the bright the video is. When you input the value here, the bright section and the dark section of the video will be adjusted accordingly. You can use this function when the whole video is too dark or too bright. Please note the video may become hazy if the value is too high. The value ranges from 0 to 100. The recommended value ranges from 40 to 60.</p>
Contrast	<p>It is to adjust monitor window contrast. The value ranges from 0 to 100. The default value is 50.</p> <p>The larger the number is, the higher the contrast is. You can use this function when the whole video bright is OK but the contrast is not proper. Please note the video may become hazy if the value is too low. If this value is too high, the dark section may lack brightness while the bright section may over exposure. The recommended value ranges from 40 to 60.</p>
Saturation	<p>It is to adjust monitor window saturation. The value ranges from 0 to 100. The default value is 50.</p> <p>The larger the number is, the strong the color is. This value has no effect on the general brightness of the whole video. The video color may become too strong if the value is too high. For the grey part of the video, the distortion may occur if the white balance is not accurate. Please note the video may not be attractive if the value is too low. The recommended value ranges from 40 to 60.</p>
Color mode	<p>It includes several modes such as standard, color. You can select corresponding color mode here, you can see hue, brightness, and contrast and etc will adjust accordingly.</p>

5.10.1.3 Encode

5.10.1.3.1 Encode

The encode interface is shown as below. See Figure 5-34.

The screenshot shows the 'Encode' configuration window with the following settings:

- Channel:** 1
- Main Stream:**
 - Code-Stream Type: Regular
 - Compression: H.264H
 - Smart Codec: Stop
 - Resolution: 1920*1080(1080P)
 - Frame Rate(FPS): 15
 - Bit Rate Type: CBR
 - Bit Rate: 2048 Kb/S
 - Reference Bit Rate: 640-6144Kb/S
 - I Frame Interval: 1sec.
 - Audio Enable:
 - Audio Format: G711a
 - Audio Source: LOCAL
 - Watermark Enable:
- Sub Stream:**
 - Video Enable:
 - Compression: H.264H
 - Resolution: 352*288(CIF)
 - Frame Rate(FPS): 15
 - Bit Rate Type: CBR
 - Bit Rate: 320 Kb/S
 - Reference Bit Rate: 32-640Kb/S
 - I Frame Interval: 1sec.
 - Audio Enable:
 - Audio Format: G711a
 - Audio Source: LOCAL
 - Watermark String: (empty)

Buttons at the bottom: Copy, Save, Refresh, Default.

Figure 5-34

Please refer to the following sheet for detailed information.

Parameter	Function
Channel	Please select a channel from the dropdown list.
SVC	SVC is so called scaled video coding. Check the box to enable this function. During the network transmission process, system discards unimportant frames when the bandwidth is not sufficient or the decode capability is low. It is to guarantee video quality and transmission fluency.
Video enable	Check the box here to enable extra stream video. This item is enabled by default.
Code stream type	It includes main stream, motion stream and alarm stream. You can select different encode frame rates form different recorded events. System supports active control frame function (ACF). It allows you to record in different frame rates. For example, you can use high frame rate to record important events, record scheduled event in lower frame rate and it allows you to set different frame rates for motion detection record and alarm record.
Smart Codec	Select Start from the dropdown list to enable smart codec function. The DVR can auto reduce the video bit stream of the non-important surveillance object to save the storage space. Please note this function is for main stream only.

Parameter	Function
Compression	<p>Compression: System supports H.264H, H.264, H.264B, and MJPEG.</p> <ul style="list-style-type: none"> ● H.264H: It is the High Profile compression algorithm. It has the high encode compression rate. It can achieve high quality encode at low bit stream. Usually we recommend this type. ● H.264 is the general compression algorithm. ● H.264B is the Baseline algorithm. Its compression rate is low. For the same video quality, it has high bit stream requirements.
Resolution	It is to set video resolution. The higher the resolution is, the better the video quality is.
Frame Rate	PAL:1~25f/s; NTSC:1~30f/s.
Bit Rate	<ul style="list-style-type: none"> ● Main stream: You can set bit rate here to change video quality. The large the bit rate is, the better the quality is. Please refer to recommend bit rate for the detailed information. ● Extra stream: In CBR, the bit rate here is the max value. In dynamic video, system needs to low frame rate or video quality to guarantee the value. The value is null in VBR mode.
Reference bit rate	Recommended bit rate value according to the resolution and frame rate you have set.
I Frame	Here you can set the P frame amount between two I frames. The value ranges from 1 to 150. Default value is 50. Recommended value is frame rate *2.
Audio source	Please select from the dropdown list. There are two options: Normal/HDCVI. In the normal mode, the audio signal comes from the Audio In. In the HDCVI mode, the audio signal comes from the coaxial cable of the camera.
Watermark enable	This function allows you to verify the video is tampered or not. Here you can select watermark bit stream, watermark mode and watermark character. Default character is DigitalCCTV. The max length is 85-digit. The character can only include number, character and underline.

5.10.1.3.2 Snapshot

The snapshot interface is shown as in Figure 5-35.

Figure 5-35

Please refer to the following sheet for detailed information.

Parameter	Function
Snapshot type	There are two modes: Timing (schedule) and Trigger. <ul style="list-style-type: none"> ● Regular snapshot is valid during the specified period you set. ● Trigger snapshot only is valid when motion detect alarm, tampering alarm or local activation alarm occurs.
Image size	It is the same with the resolution of the main stream.
Quality	It is to set the image quality. There are six levels.
Interval	It is to set snapshot frequency. The value ranges from 1s to 7s. Or you can set customized value. The max setup is 3600s/picture.
Copy	Click it; you can copy current channel setup to other channel(s).

5.10.1.3.3 Video Overlay

The video overlay interface is shown as in Figure 5-36.

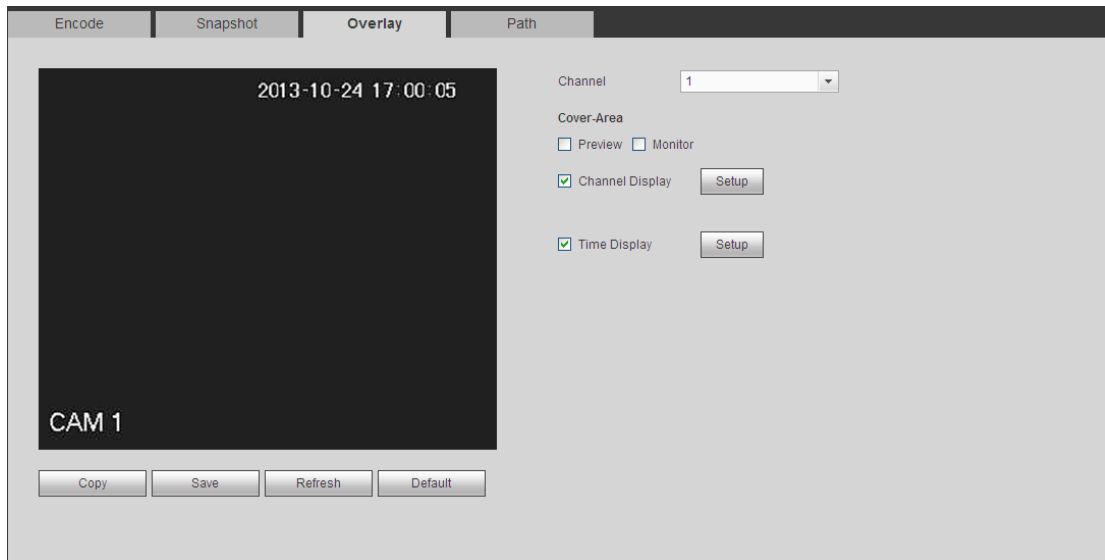

Figure 5-36



Please refer to the following sheet for detailed information.

Parameter	Function
Cover-area	Check Preview or Monitor first. Click Set button, you can privacy mask the specified video in the preview or monitor video. System max supports 4 privacy mask zones.
Time Title	You can enable this function so that system overlays time information in video window. You can use the mouse to drag the time title position. You can view time title on the live video of the WEB or the playback video.

Parameter	Function
Channel Title	<p>You can enable this function so that system overlays channel information in video window.</p> <p>You can use the mouse to drag the channel title position.</p> <p>You can view channel title on the live video of the WEB or the playback video.</p>

5.10.1.3.4 Path

The storage path interface is shown as in Figure 5-37.

Here you can set snap image saved path ( in the preview interface) and the record storage path ( in the preview interface).The default setup is C:\PictureDownload and C:\RecordDownload.

Please click the Save button to save current setup.

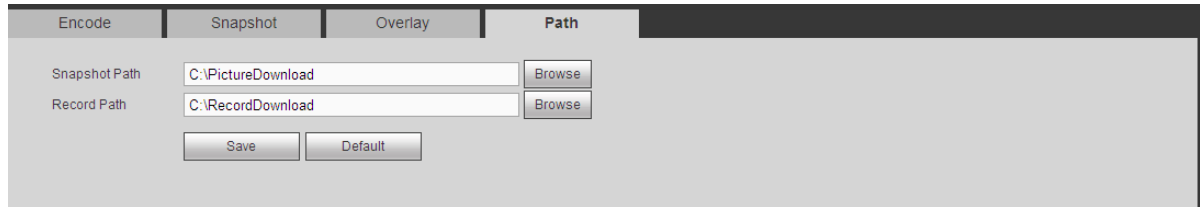

Figure 5-37

5.10.1.4 Channel Name

Here you can set channel name. See Figure 5-38.

Please note this function is for analog channel only. The digital channel name here is read-only.

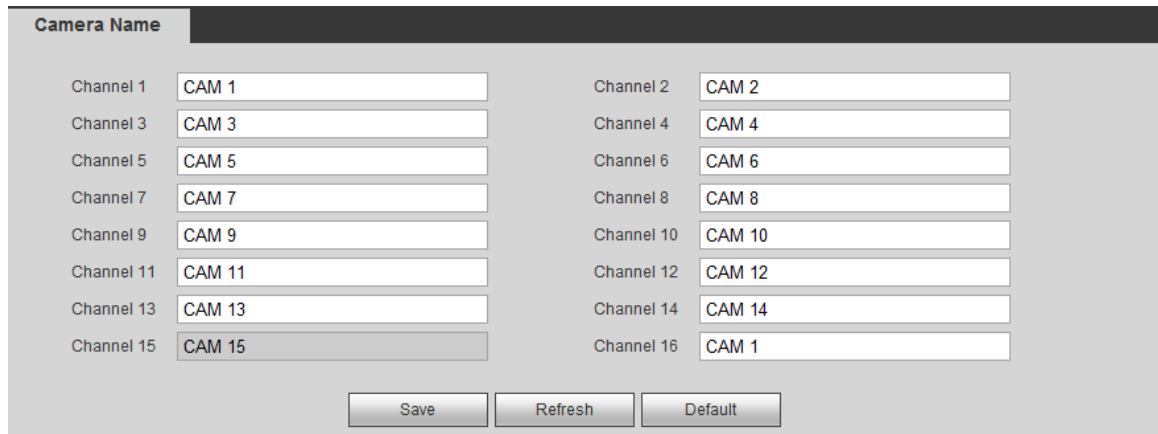

Figure 5-38

5.10.1.5 Channel Type

It is to set channel type.

- For analog channel (CVBS signal or HDCVI HD signal), you can select coaxial cable or UTP cable. Please check first and then save setup. There is no need to reboot.
- You can switch analog channel type to digital channel type if you want to connect to

network camera. The IP channel shall start from the last channel. System needs to reboot to activate current setup.

 **Note**

If there is no connected channel, the channel type here just displays previous connection record. System supports self-adaptive after camera connection.

The interface is shown as in Figure 5-39 (XVR series product) and Figure 5-40 (HCVR series product).



Important notice about XVR series product:

- Nowadays, there are mainly two analog signal types on today market: analog standard definition (CVBS) and analog HD (CVI, AHD or Other). For XVR series product, each channel supports all types of signal connection (analog signal/IP signal). For analog signal connection, the default setup is AUTO, that is to say, no matter what analog signal (CVBS, CVI, AHD or other analog HD signal) connected; the XVR can automatically recognize the signal and display the proper image. There is no need to set manually.
- If the auto recognition error occurred, XVR series product supports manual setup too. The manual setup featuring high recognition speed and usually there is no error. For example, you can set channel 1 to connect to CVI camera, channel 2 to connect to AHD camera, channel 3 to connect to CVBS camera.

CHANNEL TYPE

Channel	Analog					IP
	AUTO	CVI	AHD	CVBS	OTHER	
1	<input checked="" type="checkbox"/>	<input type="checkbox"/>	<input type="checkbox"/>	<input type="checkbox"/>	<input type="checkbox"/>	<input type="checkbox"/>
2	<input checked="" type="checkbox"/>	<input type="checkbox"/>	<input type="checkbox"/>	<input type="checkbox"/>	<input type="checkbox"/>	<input type="checkbox"/>
3	<input checked="" type="checkbox"/>	<input type="checkbox"/>	<input type="checkbox"/>	<input type="checkbox"/>	<input type="checkbox"/>	<input type="checkbox"/>
4	<input checked="" type="checkbox"/>	<input type="checkbox"/>	<input type="checkbox"/>	<input type="checkbox"/>	<input type="checkbox"/>	<input type="checkbox"/>
5	<input checked="" type="checkbox"/>	<input type="checkbox"/>	<input type="checkbox"/>	<input type="checkbox"/>	<input type="checkbox"/>	<input type="checkbox"/>
6	<input checked="" type="checkbox"/>	<input type="checkbox"/>	<input type="checkbox"/>	<input type="checkbox"/>	<input type="checkbox"/>	<input type="checkbox"/>
7	<input checked="" type="checkbox"/>	<input type="checkbox"/>	<input type="checkbox"/>	<input type="checkbox"/>	<input type="checkbox"/>	<input type="checkbox"/>
8	<input checked="" type="checkbox"/>	<input type="checkbox"/>	<input type="checkbox"/>	<input type="checkbox"/>	<input type="checkbox"/>	<input type="checkbox"/>
9	<input checked="" type="checkbox"/>	<input type="checkbox"/>	<input type="checkbox"/>	<input type="checkbox"/>	<input type="checkbox"/>	<input type="checkbox"/>
10	<input checked="" type="checkbox"/>	<input type="checkbox"/>	<input type="checkbox"/>	<input type="checkbox"/>	<input type="checkbox"/>	<input type="checkbox"/>
11	<input checked="" type="checkbox"/>	<input type="checkbox"/>	<input type="checkbox"/>	<input type="checkbox"/>	<input type="checkbox"/>	<input type="checkbox"/>
12	<input checked="" type="checkbox"/>	<input type="checkbox"/>	<input type="checkbox"/>	<input type="checkbox"/>	<input type="checkbox"/>	<input type="checkbox"/>
13	<input checked="" type="checkbox"/>	<input type="checkbox"/>	<input type="checkbox"/>	<input type="checkbox"/>	<input type="checkbox"/>	<input type="checkbox"/>
14	<input checked="" type="checkbox"/>	<input type="checkbox"/>	<input type="checkbox"/>	<input type="checkbox"/>	<input type="checkbox"/>	<input type="checkbox"/>
15	<input checked="" type="checkbox"/>	<input type="checkbox"/>	<input type="checkbox"/>	<input type="checkbox"/>	<input type="checkbox"/>	<input type="checkbox"/>
16	<input checked="" type="checkbox"/>	<input type="checkbox"/>	<input type="checkbox"/>	<input type="checkbox"/>	<input type="checkbox"/>	<input type="checkbox"/>

*Tips:Disable one analog channel, you can add one IP channel. IP channel setup shall begin from the last channel.

Save Refresh Default Add IP CAM

Figure 5-39

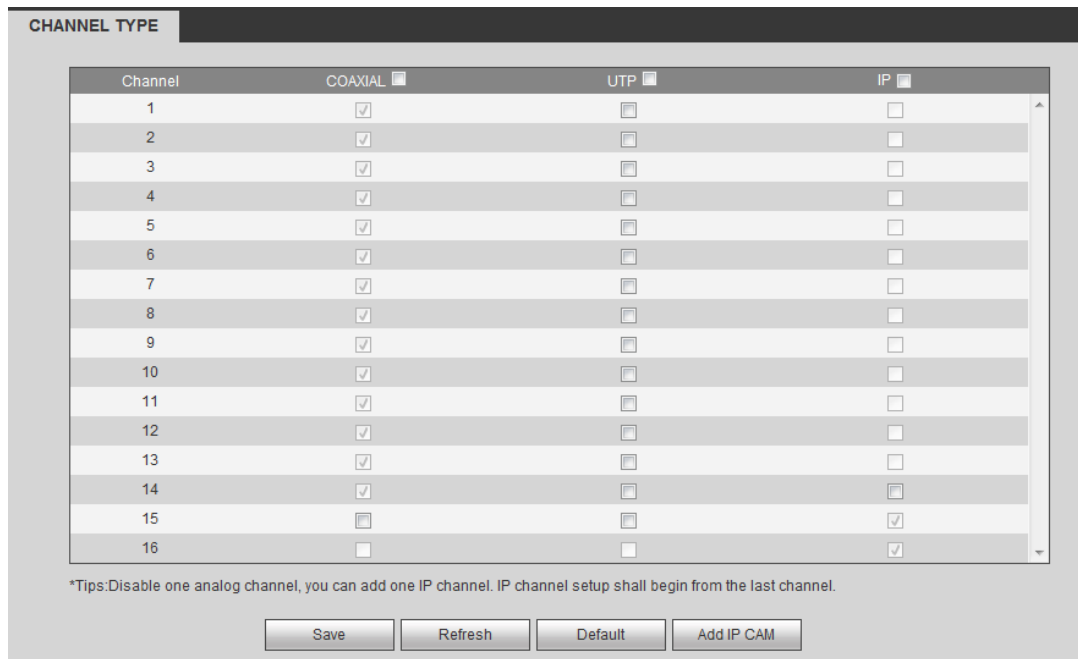



Figure 5-40

Important

Add/cancel IP CAM function is for some series product only.

- Add IP CAM: Click it; you can add corresponding X IP channels. Here X refers to the product channel amount. Please refer to chapter 1.3 Specifications for IP channel amount information. System needs to restart to activate new setup.
For example, there is a 4-channel analog device, after the A/D switch, it can max supports 4 analog channels and 4 IP channels. Once it has become the 3+1 mode (3 analog channels+1 IP channel), you click  button, system becomes 3+5 mode (3 analog channels+5 IP channel).
- Cancel IP CAM: Click it, you can cancel IP channel. System needs to restart to restore original status.

5.10.2 Network

5.10.2.1 TCP/IP

The single-Ethernet port interface is shown as in Figure 5-41.

TCP/IP

Ethernet Port: Ethernet Port1

IP Version: IPv4

MAC Address: 90 . 02 . a9 . da . 9c . 77

Mode: STATIC DHCP

IP Address: 10 . 15 . 6 . 145

Subnet Mask: 255 . 255 . 0 . 0

Default Gateway: 10 . 15 . 0 . 1

Preferred DNS: 10 . 1 . 2 . 80

Alternate DNS: 10 . 1 . 2 . 81

MTU: 1500

LAN Download

Save Refresh Default

Figure 5-41

The dual-Ethernet port interface is shown as in Figure 5-42.

TCP/IP

Network Mode: Multi-address

Default Card: Ethernet Card1

Ethernet Card: Ethernet Card1

Mode: STATIC DHCP

MAC Address: 20 : 13 : 10 : 13 : 16 : 33

MTU: 1500

IP Version: IPv4

IP Address: 10 . 15 . 6 . 252

Subnet Mask: 255 . 255 . 0 . 0

Default Gateway: 10 . 15 . 0 . 1

Preferred DNS: 8 . 8 . 8 . 8

Alternate DNS: 8 . 8 . 4 . 4

LAN Download

Save Refresh Default

Figure 5-42

Please refer to the following sheet for detailed information.

Parameter	Function
Network mode	<p>It includes: single multiple-address, fault tolerance, load balance.</p> <ul style="list-style-type: none"> ● Multiple-address: eth1/eth2 operates separately. You can use the services such as HTTP, RTP service via eth1/eth2. Usually you need to set one default card (default setup is eth1) to request the auto network service from the device-end such as DHCP, email, FTP and etc. In multiple-address mode, system network status is shown as offline once one card is offline. ● Fault-tolerance: In this mode, device uses bond0 to communicate with the external devices. You can focus on one host IP address. At the same time, you need to set one master card. Usually there is only one running card (master card).System can enable alternate card when the master card is malfunction. The system is shown as offline once all cards are offline. Please note all cards shall be in the same LAN. ● Load balance: In this mode, device uses bond0 to communicate with the external device. The all cards are working now and bearing the network load. Their network load are general the same. The system is shown as offline once all cards are offline. Please note all cards shall be in the same LAN.
Mode	<p>There are two modes: static mode and the DHCP mode.</p> <ul style="list-style-type: none"> ● The IP/submask/gateway are null when you select the DHCP mode to auto search the IP. ● If you select the static mode, you need to set the IP/submask/gateway manually. ● If you select the DHCP mode, you can view the IP/submask/gateway from the DHCP. ● If you switch from the DHCP mode to the static mode, you need to reset the IP parameters. ● Besides, IP/submask/gateway and DHCP are read-only when the PPPoE dial is OK.
Mac Address	It is to display host Mac address.
IP Version	<p>It is to select IP version. IPV4 or IPV6.</p> <p>You can access the IP address of these two versions.</p>
IP Address	Please use the keyboard to input the corresponding number to modify the IP address and then set the corresponding subnet mask and the default gateway.
Preferred DNS	DNS IP address.
Alternate DNS	Alternate DNS IP address.

Parameter	Function
MTU	<p>It is to set MTU value of the network adapter. The value ranges from 1280-7200 bytes. The default setup is 1500 bytes.</p> <p>The following MTU value is for reference only.</p> <ul style="list-style-type: none"> ● 1500: Ethernet information packet max value and it is also the default value. It is the typical setup when there is no PPPoE or VPN. It is the default setup of some router, switch or the network adapter. ● 1492: Recommend value for PPPoE. ● 1468: Recommend value for DHCP. ● 1450: Recommended value for VPN.
<p>For the IP address of IPv6 version, default gateway, preferred DNS and alternate DNS, the input value shall be 128-digit. It shall not be left in blank.</p>	
LAN load	<p>System can process the downloaded data first if you enable this function. The download speed is 1.5X or 2.0X of the normal speed.</p>

5.10.2.2 Connection

The connection interface is shown as in Figure 5-43.

The screenshot shows a configuration window titled "Connection". It contains the following fields and values:

- Max Connection: 128 (range: 0-128)
- TCP Port: 37777 (range: 200-65535)
- UDP Port: 37778 (range: 200-65535)
- HTTP Port: 80 (range: 1-65535)
- HTTPS Port: 443 (range: 128-65535)
- RTSP Port: 554 (range: 128-65535)
- RTSP Format: rtsp://<User Name>:<Password>@<IP Address>:<Port>/cam/realmonitor?channel=1&subtype=0
channel: Channel, 1-32; subtype: Code-Stream Type, Main Stream 0, Sub Stream 1.

At the bottom, there are three buttons: "Save", "Refresh", and "Default".

Figure 5-43

Please refer to the following sheet for detailed information.

Parameter	Function
Max connection	It is the max Web connection for the same device. The value ranges from 1 to 128. The default setup is 128.
TCP port	The default value is 37777. You can input the actual port number if necessary.
UDP port	The default value is 37778. You can input the actual port number if necessary.
HTTP port	The default value is 80. You can input the actual port number if necessary.
HTTPS	The default value is 443. You can input the actual port number if necessary.

Parameter	Function
RTSP port	<ul style="list-style-type: none"> ● The default value is 554. Please leave it in blank if you are using default value. When you are using QuickTime or VLC, you can use the following format. BlackBerry cellphone support this function too. ● Real-time monitoring URL format: please require real-time RTSP media server, require channel number, and bit stream type in URL. You may need username and password. ● When you are using BlackBerry, please set encode mode as H.264B, resolution to CIF and turn off audio. <p>URL format is: rtsp://username:password@ip:port/cam/realmonitor?channel=1&subtype=0 username/password/IP and port.</p> <ul style="list-style-type: none"> ● Username: such as admin. ● Password: such as admin. ● IP: Device IP such as 10.7.8.122. ● Port: Port value. The default setup is 554. You can leave in blank if you are using default value. ● Channel: channel number. It starts with 1. If it is channel 2, then channel=2. ● Subtype: bit stream type. The main stream is 0(subtype=0), subtype is 1(subtype=1). <p>For example, if you want to get the sub stream of the channel 2, the URL is: rtsp://admin:admin@10.12.4.84:554/cam/realmonitor?channel=2&subtype=1. If there is no authentication, there is no need to specify user name and password, you can use the following format: rtsp://ip:port/cam/realmonitor?channel=1&subtype=0</p>
POS port	The value ranges from 1 to 65535. The default setup is 38800.

5.10.2.3 WIFI



Note

This function is for some series products only.

This function allows you to connect the DVR to the network via the WIFI.

Step 1 From main window->Setup->Network->WIFI.

Enter WIFI interface. See Figure 5-44.

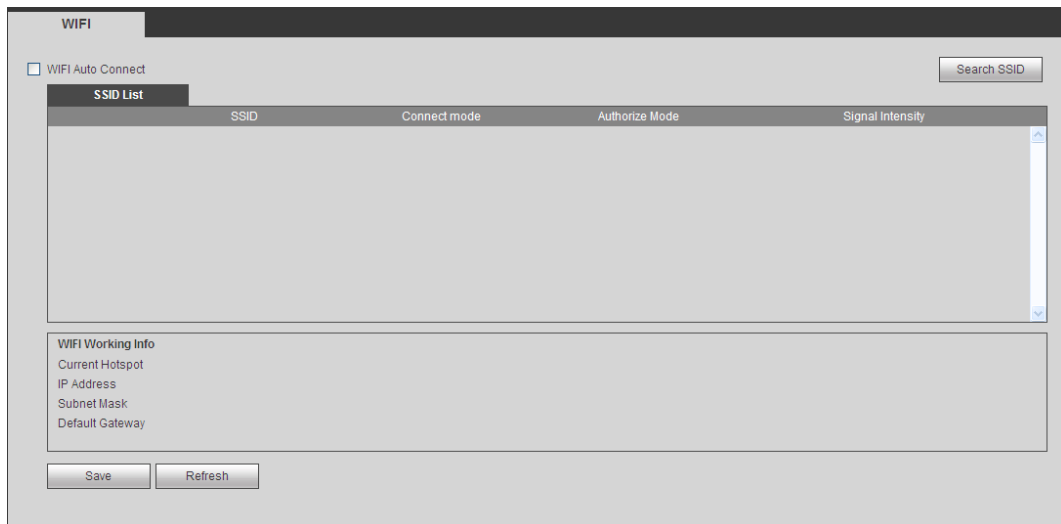

Figure 5-44

- Step 2 Check the box to enable WIFI function and then click the Search SSID button. It is to view all the wireless network information in the following list.
- Step 3 Double click a name to connect to it.
Click Refresh button, you can view latest connection status.

5.10.2.4 3G/4G

It is to connect to the 3G/4G network to receive alarm information, view device state, audio/video and etc.

5.10.2.4.1 CDMA/GPRS

- Step 1 From main window->Setup->Network->3G/4G.
Enter 3G/4G interface is shown as in Figure 5-45.

Note

After you connected the 3G/4G module, you can view the module information and wireless signal. If there is no information, click Search button to search.

Figure 5-45

Step 2 Check the Boot up box to enable this function and then set parameters.

Parameter	Function
WLAN type	Here you can select 3G/4G network type to distinguish the 3G/4G module from different ISP. The types include WCDMA,CDMA1x and etc.
APN/Dial No.	Here is the important parameter of PPP.
Authorization	It includes PAP,CHAP,NO_AUTH.
Pulse interval	It is to set time to end 3G/4G connection after you close extra stream monitor. For example, if you input 60 here, system ends 3G/4G connection after you close extra stream monitor 60 seconds.
Important <ul style="list-style-type: none"> ◇ If the pulse interval is 0, then system does not end 3G/4G connection after you close the extra stream monitor. ◇ Pulse interval here is for extra stream only. This item is null if you are using main stream to monitor. 	

Step 3 Check Dial/SMS activate

Step 4 Click Save button to connect device to 3G/4G network.

View the IP address if the connection is OK.

5.10.2.4.2 Mobile

Make sure the SIM card and the 3G/4G module supports SMS function.

Before you set cellphone, please go to the previous chapter to enable Dial/SMS activate function.

Step 1 From main window->Setup->Network->3G/4G->Mobile.

Enter mobile setup interface. See Figure 5-46.

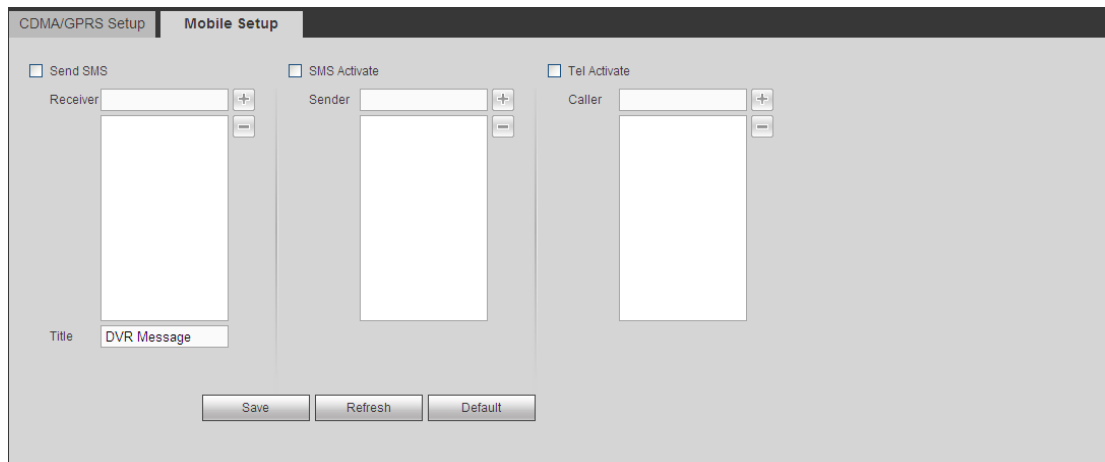



Figure 5-46

Step 2 Activate or turn off the 3G/4G connected phone or mobile phone, or the phone you set to get alarm message.

Step 3 Input sender/caller cellphone number and then click  to add the cellphone user to the list.

 **Note**

Select a number in the list and then click  to delete current number.

- **Send SMS:** Check the box to enable this function. Various kinds of alarm can trigger the DVR to send out alarm message to the receiver.
- **SMS activate:** Check the box to enable this function. The user can send out the message to the receiver to enable/disable 3G/4G module.
- **Telephone activate:** Check the box to enable this function. The user can call the 3G/4G user to enable/disable 3G/4G module.

Step 4 Click Save to complete the setup.

5.10.2.5 PPPoE

 **Note**

This function is for some series products only.

Use PPPoE(Point-to-Point Protocol over Ethernet) to establish network connection. Device can get a dynamic IP address in the WAN. Before the operation, please contact your ISP (Internet service provider) for PPPoE user name and password.

Step 1 From main window->Setup->Network->PPPoE.

Enter PPPoE interface. See Figure 5-47.

Figure 5-47

- Step 2 Check the box to enable PPPoE function and input the PPPoE user name and password.
- Step 3 Click Save to complete the setup.
- Step 4 Device connects to the internet via PPPoE. You can get the IP address in the WAN from the IP address column.

Note

After enable PPPoE function, the IP address on the TCP/IP (Setup->Network->TCP/IP) interface is read-only.

5.10.2.6 DDNS

Note

The server from the third-party may collect your device information after you enable DDNS function.

The DDNS interface is shown as in Figure 5-48.

The DDNS is to set to connect the various servers so that you can access the system via the server. Please go to the corresponding service website to apply a domain name and then access the system via the domain. It works even your IP address has changed.

Please select DDNS from the dropdown list (Multiple choices). Before you use this function, please make sure your purchased device support current function.

Figure 5-48

Please refer to the following sheet for detailed information.

Parameter	Function
DDNS Type	Server name and address provided by the DDNS service

Parameter	Function
Server IP	provider. <ul style="list-style-type: none"> ● Dyndns DDNS is members.dyndns.org. ● NO-IP DDNS is dynupdate.no-ip.com. ● CN99 DDNS is members.3322.org.
Domain Name	The domain name registered on the DDNS service provider website.
User	Input the user name and password got from the DDNS service provider. Make sure you have logged in the DDNS service provider website to register an account (user name and password).
Password	
Update period	After DDNS boots up, it sends out refresh query regularly. The unit is minute.

After setting, click Save button.

Input full domain name on the browser and click Enter button. The setting is right if you can view device WEB interface. Otherwise, please check the parameters.

5.10.2.7 Sync Time Right

It is to allow the specified IP host to sync time with the device or change device time.

Background Information

If the IP host and the device are not the same, it may result in file search failure; data backup is not the same and cannot record and operate the device. So, there is need to specify the device and IP host time synchronization mechanism and make sure the device and IP host time is the same.

Steps:

Step 1 From main window->Setup->Network->Sync time right.
Enter sync time interface. See Figure 5-49.



Figure 5-49

Step 2 Check the box to enable this function.

Step 3 Click Add button, and then set IP address in the pop-up interface click Save button.

Refer to the following table to set parameters.

Parameter	Function
IP address	Input the device IP address you want to add.
IP segment	Input the start address and end address of the IP segment you want to add.
IPv4	The IP address adopts IPv4 mode such as 172.16.5.10.
IPv6	The IP address adopts IPv6 mode such as aa:aa:aa:aa:aa:aa:aa:aa.
MAC address	Input the mac address you want to add.

Step 4 Click Save to complete setup.

Step 5 Login the device WEB on the IP host.

From Setup->System->General->Date and time, change device time or click Sync time with PC. Device pops the corresponding dialogue box.

5.10.2.8 Email

The email interface is shown as in Figure 5-50.

Figure 5-50

Please refer to the following sheet for detailed information.

Parameter	Function
Enable	Please check the box here to enable email function.
SMTP Server	Input server address and then enable this function.
Port	Default value is 25. You can modify it if necessary.
Anonymity	For the server supports the anonymity function. You can auto login anonymously. You do not need to input the user name, password and the sender information.



Parameter	Function
User Name	The user name of the sender email account.
Password	The password of sender email account.
Sender	Sender email address.
Encryption type	The encryption type includes NONE, SSL and TLS.  Note SMTP adopts TLS encryption mode by default.
Subject	Input email subject here.
Attachment	System can send out the email of the snapshot picture once you check the box here.
Receiver	Input receiver email address here. Max three addresses. It supports SSL, TLS email box.
Interval	The send interval ranges from 0 to 3600 seconds. 0 means there is no interval. Please note system will not send out the email immediately when the alarm occurs. When the alarm, motion detection or the abnormality event activates the email, system sends out the email according to the interval you specified here. This function is very useful when there are too many emails activated by the abnormality events, which may result in heavy load for the email server.
Health mail enable	Please check the box here to enable this function.
Update period (interval)	This function allows the system to send out the test email to check the connection is OK or not. Please check the box to enable this function and then set the corresponding interval. System can send out the email regularly as you set here.
Email test	The system will automatically sent out a email once to test the connection is OK or not .Before the email test, please save the email setup information.

5.10.2.9 UPnP

It allows you to establish the mapping relationship between the LAN and the public network.

Here you can also add, modify or remove UPnP item. See Figure 5-51.

- In the Windows OS, From Start->Control Panel->Add or remove programs. Click the “Add/Remove Windows Components” and then select the “Network Services” from the Windows Components Wizard.
- Click the Details button and then check the “Internet Gateway Device Discovery and Control client” and “UPnP User Interface”. Please click OK to begin installation.
- Enable UPnP from the Web. If your UPnP is enabled in the Windows OS, the DVR can auto detect it via the “My Network Places”

Parameter	Function	
Port enable/disable	Check the box to enable/disable this function.	
LAN IP	It is the router IP in the LAN.	Device can auto get the IP address if the UPnP function succeeded. Do not need to set.
WAN IP	It is the router IP in the WAN.	
Status	When the UPnP is offline, it shows as "Searching". When the UPnP works it shows "Success"	
Port mapping list	<p>It is the same information on the UPnP list of the router.</p> <ul style="list-style-type: none"> ● Service name:Defined by user. ● Protocol: Protocol type ● Internal port:Port that has been mapped in the router. ● External port:Port that has been mapped locally. <p> Note</p> <ul style="list-style-type: none"> ● When you are setting the router external port, please use 1024~5000 port. Do not use well-known port 1~255 and the system port 256~1023 to avoid conflict. ● When there are several devices in the same LAN, please arrange the port mapping properly in case several devices are mapping to the same external port. ● Please make sure the mapping port is available. ● For the TCP and UDP, please make sure the internal port and external port are the same to guarantee the proper data transmission. 	
Modify	Click  , you can change WAN port value.	

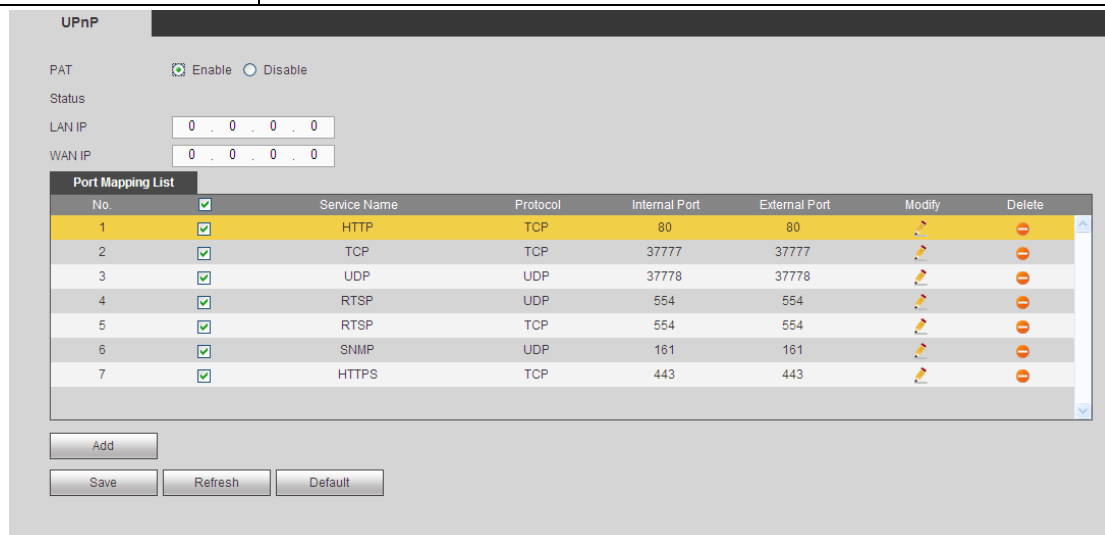

Figure 5-51

5.10.2.10 SNMP

Note

This function is for some series products only.

SNMP is an abbreviation of Simple Network Management Protocol. It provides the basic network management frame of the network management system. The SNMP widely used in many environments. It is used in many network device, software and system.

Preparation

- Install corresponding software tool such as MIB Builder and MG-SOFT MIB Browser.
- Contact technical engineer to get two MIB files of the current version.

Steps

- Step 1 From main window->Setup->Network->SNMP.
Enter SNMP interface is shown as in Figure 5-52.

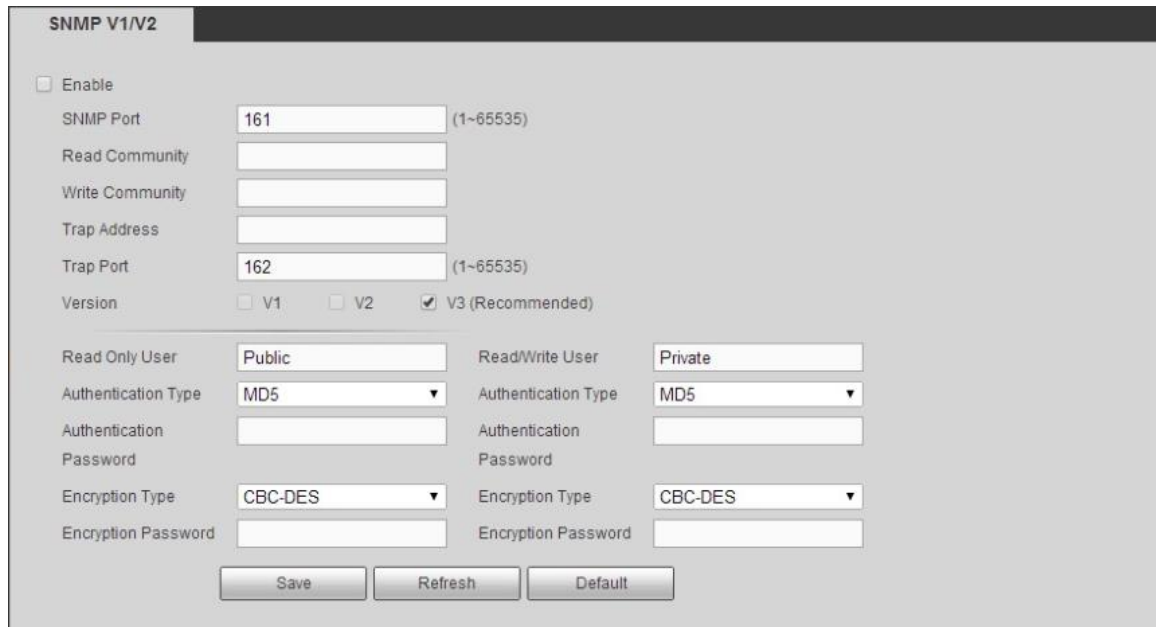



The image shows a web-based configuration interface for SNMP V1/V2. The interface is titled "SNMP V1/V2" and contains several sections of settings. At the top left, there is an "Enable" checkbox. Below it, the "SNMP Port" is set to 161, with a range of (1-65535) indicated. The "Read Community" and "Write Community" fields are empty. The "Trap Address" field is also empty. The "Trap Port" is set to 162, with a range of (1-65535) indicated. The "Version" section has three radio buttons: "V1", "V2", and "V3 (Recommended)", with "V3" selected. Below this, there are two columns of settings for "Read Only User" and "Read/Write User". The "Read Only User" is set to "Public" and the "Read/Write User" is set to "Private". Both have "Authentication Type" set to "MD5" and "Authentication Password" fields. The "Encryption Type" is set to "CBC-DES" and "Encryption Password" fields are also present. At the bottom, there are three buttons: "Save", "Refresh", and "Default".

Figure 5-52

- Step 2 Check the enable box to enable SNMP function. Trap address refers to the PC address that has installed MG-SOFT MIB Browser. The rest settings adopt default setup.

Parameter	Function
SNMP Port	The listening port of the proxy program of the device. It is a UDP port not a TCP port. The value ranges from 1 to 65535. The default value is 161.
Read/write community	The read/write community string the agent applications supports.
Trap address	The destination address of the Trap information from the proxy program of the device.
Trap port	The destination port of the Trap information from the proxy program of the device. It is for the gateway device and the

Parameter	Function
	client-end PC in the LAN to exchange the information. It is a non-protocol connection port. It has no effect on the network applications. It is a UDP port not TCP port. The value ranges from 1 to 165535. The default value is 162.
Read-only user	It is to set read-only user to access the device.  Note It supports read-only function if you use current account to login.
Read-write user Type	It is to set read-write user to access the device.  Note It supports read-write function if you use current account to login.
Authentication type	It includes MD5 and SHA. System automatically recognizes the mode.
Authentication password/encryption password	It is to set authentication password and encryption password. The password shall be at least 8-digit.
Encryption type	It is to set encryption mode. The default mode is CBC-DES.
SNMP version	<ul style="list-style-type: none"> ● Check V1, system only processes the information of V1. ● Check V2, system only processes the information of V2. ● Check V3, system only processes the information of V3.  Note System adopts V3 by default. V1 or V2 may not be safe.

Step 3 Compile the above mentioned two MIB file via the software MIB Builder.

Step 4 Run MG-SOFT MIB Browser to load the file from the previous step to the software.

Step 5 Input the device IP you want to manage in the MG-SOFT MIB Browser. Please set the corresponding version for your future reference.

Step 6 Open the tree list on the MG-SOFT MIB Browser; you can get the device configuration. It is to view the device has how many video channels, audio channels, application version and etc.

5.10.2.11 Multicast

The multicast interface is shown as in Figure 5-53.

Multicast is a transmission mode of data packet. When there is multiple-host to receive the same data packet, multiple-cast is the best option to reduce the broad width and the CPU load. The source host can just send out one data to transit. This function also depends on the relationship of the group member and group of the outer.

Parameter	Function
IP address	The multicast IP address (0.0.0.0~255.255.255.255).
Port	The multicast port value(1025~65000).

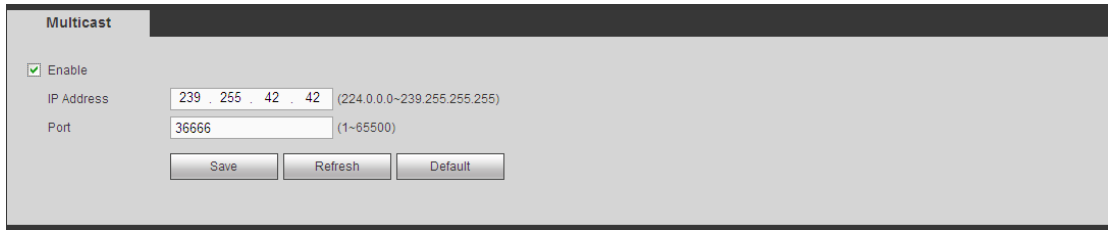

Figure 5-53

Click Save to complete the setup. Login and monitor.

Use WEB to login, you can see the following interface. See Figure 5-54. Select login type as the Multicast from the dropdown list. After you logged in the Web, the Web can automatically get multiple cast address and add it to the multiple cast groups. You can enable real-time monitor function to view the video.



Figure 5-54

5.10.2.12 Auto Register

The auto register interface is shown as below. See Figure 5-55.

This function allows the device to auto register to the proxy you specified. In this way, you can use the client-end to access the DVR and etc via the proxy. Here the proxy has a switch function. In the network service, device supports the server address of IPv4 or domain.

Please follow the steps listed below to use this function.

Please set proxy server address, port, and sub-device name at the device-end. Please enable the auto register function, the device can auto register to the proxy server.



Figure 5-55

Parameter	Function
Server IP address	The server IP address or server domain name you want to register.
Port	The auto registration port value of the server.
Sub-device ID	The device ID allocated by the server.

5.10.2.13 Alarm Centre

The alarm center interface is shown as below. See Figure 5-56.

This interface is reserved for you to develop. System can upload alarm signal to the alarm center when local alarm occurs.

Before you use alarm center, please set server IP, port and etc. When an alarm occurs, system can send out data as the protocol defined, so the client-end can get the data.

Figure 5-56

Parameter	Function
Enable	Check the box to enable alarm center function.
Server IP	The IP address and the communication port of the PC that has installed the alarm client.
Port	
Self-report time	Select alarm upload time from the dropdown list.

5.10.2.14 P2P

Note

After you enable P2P function and connect the device to the Internet, we are going to collect device information including but not limited to device IP address, device name, device firmware, device SN. The collected information is only to access the device remotely.

You can use your cell phone to scan the QR code and add it to the cell phone client. Via the SN from scanning the QR code, you can access the device in the WAN. Please refer to the P2P operation manual included in the resources CD.

The P2P interface is shown as in Figure 5-57.

Check the Enable box to enable P2P function and then click the Save button. Now you can view the device status and SN.

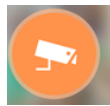

Figure 5-57

Here we use cell phone APP to continue.

Step 1 Use cell phone to scan the QR code and download the APP.

Step 2 After installation, run the APP and Live Preview, enter the main interface. Now you can add device to the APP.



1. Open App; tap  to go to the Live preview.

2. Tap  at the top left corner, you can see the main menu.

3. Tap Device manager button, you can use several modes (P2P/DDNS/IP and etc) to add the device. Click  to save current setup. Tap Start Live preview to view all-channel video from the connected device. See Figure 5-58.

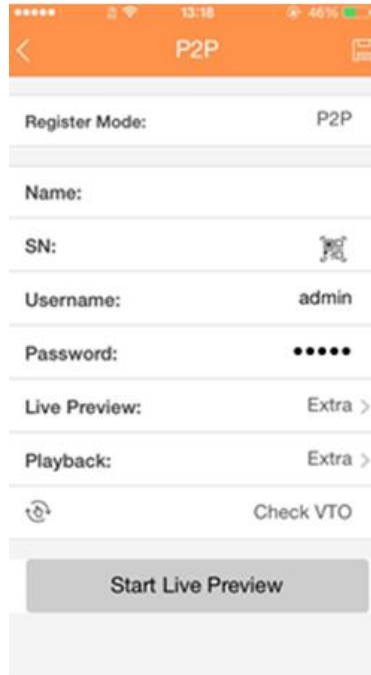

Figure 5-58

5.10.3 Event

5.10.3.1 Video detect

The video detect includes motion detect, video loss, tampering, scene change and diagnosis.

5.10.3.1.1 Motion Detect

After analysis video, system can generate a motion detect alarm when the detected moving signal reached the sensitivity you set here.

The motion detect interface is shown as in Figure 5-59.

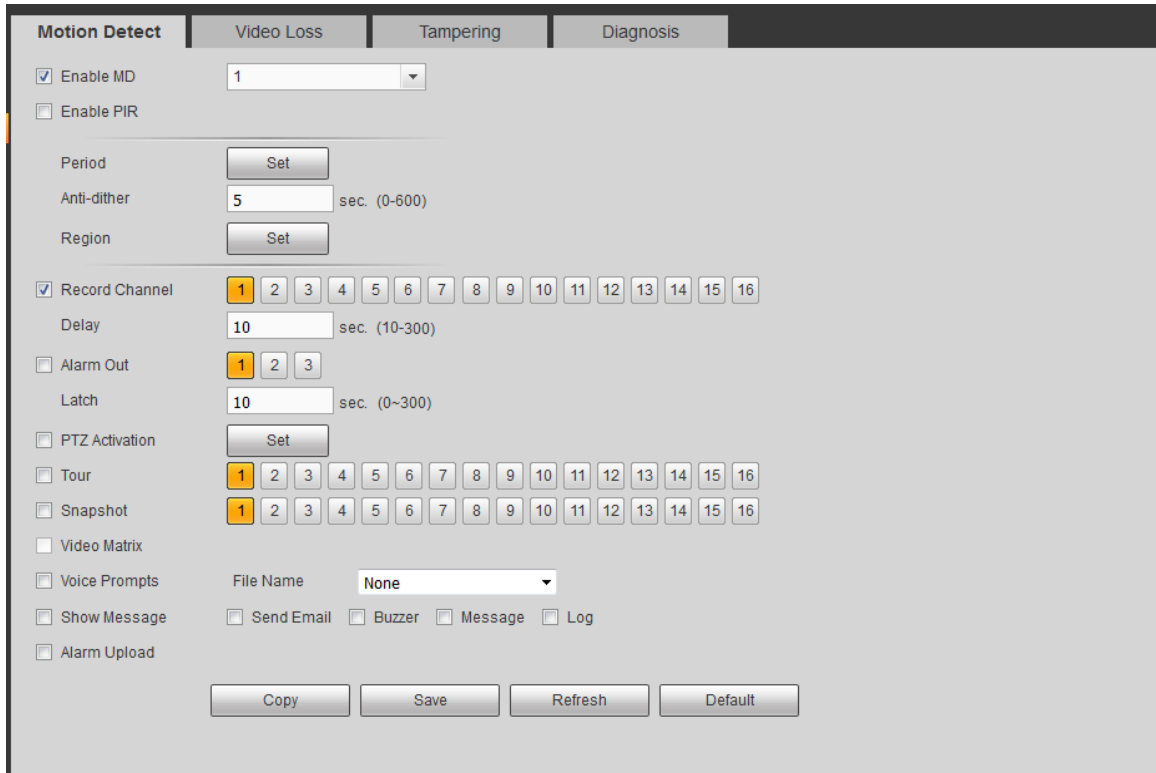

Figure 5-59

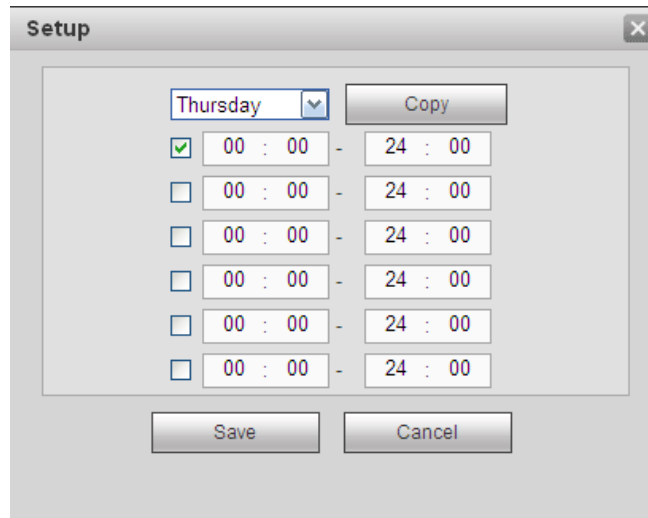

Figure 5-60

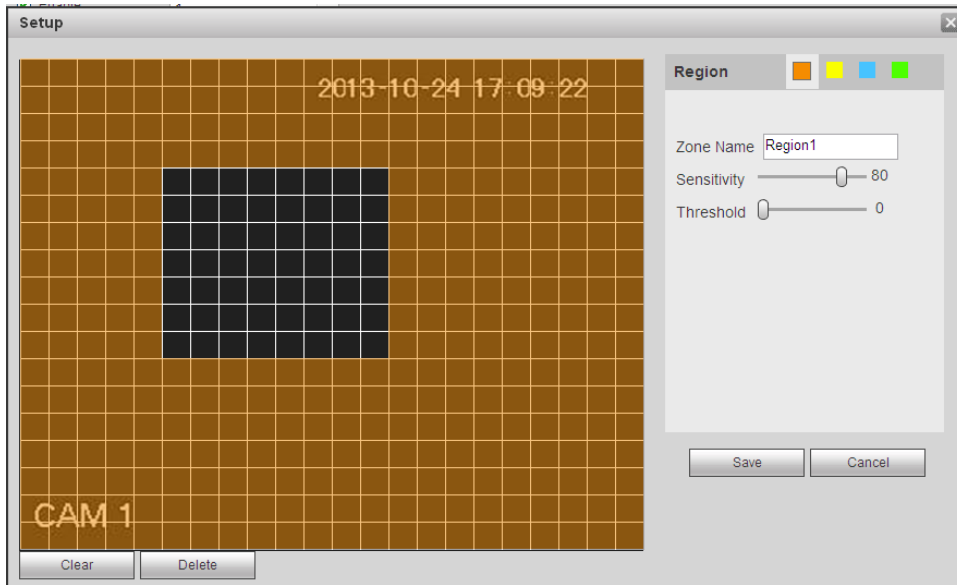

Figure 5-61

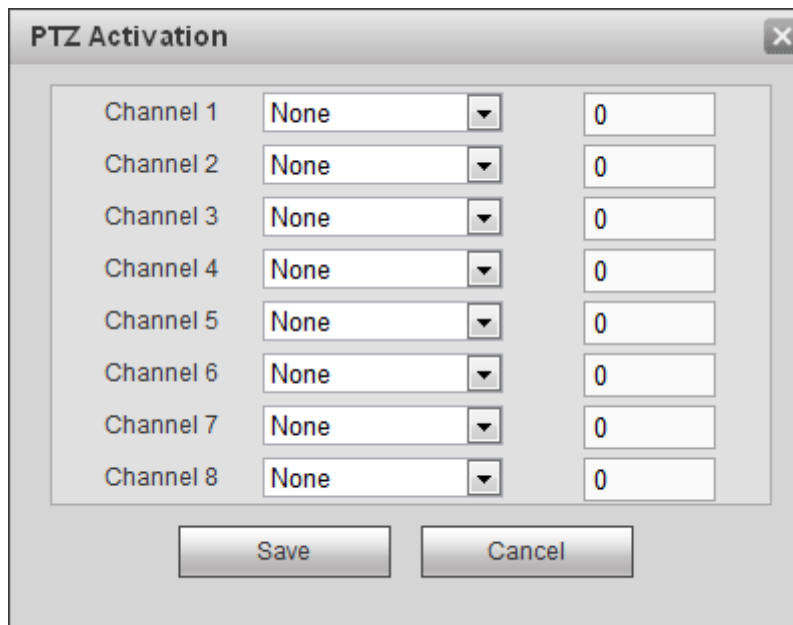



Figure 5-62

Please refer to the following sheet for detailed information.

Parameter	Function
Enable MD	You need to check the box to enable motion detection function. Please select a channel from the dropdown list.
Enable PIR	PIR function help enhance the motion detect accuracy and validity. It is to filter the false alarm triggered by leaves, small fly and insects. The PIR detection zone is smaller than the camera angle of view. The PIR function is enabled by default if the connected remote device supports the PIR function. When the PIR function is on, motion detection function is on by default. The motion detect event

Parameter	Function
	<p>occurs when these two function are enabled at the same time. If the PIR function is disabled, check the enable box to enable the general motion detect function.</p> <p> Note</p> <ul style="list-style-type: none"> ● The channel type shall be CVI if you want to enable PIR function. ● If the remote device does not support PIR function, the PIR item on the interface is grey or is hiding. That is to say, the PIR function is null. ● The interface does not display PIR enable state if current DV does not support PIR function.
Period	<p>Motion detection function becomes activated in the specified periods. See Figure 5-60.</p> <p>There are six periods in one day. Please draw a circle to enable corresponding period.</p> <p>Click OK button, system goes back to motion detection interface, please click save button to exit.</p>
Anti-dither	<p>System only memorizes one event during the anti-dither period. The value ranges from 5s to 600s.</p>
Sensitivity	<p>There are six levels. The sixth level has the highest sensitivity.</p>
Region	<p>If you select motion detection type, you can click this button to set motion detection zone. The interface is shown as in Figure 5-61. Here you can set motion detection zone. There are four zones for you to set. Please select a zone first and then left drag the mouse to select a zone. The corresponding color zone displays different detection zone. You can click Fn button to switch between the arm mode and disarm mode. In arm mode, you can click the direction buttons to move the green rectangle to set the motion detection zone. After you completed the setup, please click ENTER button to exit current setup. Do remember click save button to save current setup. If you click ESC button to exit the region setup interface system will not save your zone setup.</p>
Record channel	<p>System auto activates motion detection channel(s) to record once an alarm occurs. Please note you need to set motion detect record period and go to Storage-> Schedule to set current channel as schedule record.</p>
Record Delay	<p>System can delay the record for specified time after alarm ended. The value ranges from 10s to 300s.</p>
Alarm out	<p>Enable alarm activation function. You need to select alarm output port so that system can activate corresponding alarm device when an alarm occurs.</p>
Latch	<p>System can delay the alarm output for specified time after an</p>

Parameter	Function
	alarm ended. The value ranges from 1s to 300s.
Video Matrix	This function is for motion detect only. Check the box here to enable video matrix function. Right now system supports one-channel tour function. System takes “first come and first serve” principle to deal with the activated tour. System will process the new tour when a new alarm occurs after previous alarm ended. Otherwise it restores the previous output status before the alarm activation.
Snapshot	You need to check the box here to enable this function. You can set corresponding channel to snapshot when motion detect alarm occurs.
Show message	System can pop up a message to alarm you in the local host screen if you enabled this function.
Buzzer	Check the box here to enable this function. The buzzer beeps when an alarm occurs.
Alarm upload	System can upload the alarm signal to the center (Including alarm center).
Message	When 3G network connection is OK, system can send out a message when motion detect occurs.
Send Email	If you enabled this function, System can send out an email to alert you when an alarm occurs.
Tour	You need to check the box here to enable this function. System begins 1-window or multiple-window tour display among the channel(s) you set to record when an alarm occurs.
PTZ Activation	Here you can set PTZ movement when an alarm occurs. Such as go to preset X. See Figure 5-62.
Log	Check the box here, system can record motion detect event log.

5.10.3.1.2 Video Loss

The video loss interface is shown as in Figure 5-63.

After analysis video, system can generate a video loss alarm when the detected moving signal reached the sensitivity you set here.

Please note video loss does not support anti-dither, sensitivity, region setup. For rest setups, please refer to chapter 5.10.3.1.1 motion detect for detailed information.

Motion Detect	Video Loss	Tampering	Diagnosis
<input checked="" type="checkbox"/> Enable	1		
Period	<input type="button" value="Setup"/>		
CAM AntiDither	0 sec. (0-300)		
<input checked="" type="checkbox"/> Record Channel	<input type="button" value="Setup"/>		
Delay	10 sec. (10-300)		
<input checked="" type="checkbox"/> Alarm Out	1 2 3		
Latch	10 sec. (0~300)		
<input type="checkbox"/> PTZ Activation	<input type="button" value="Setup"/>		
<input type="checkbox"/> Tour	<input type="button" value="Setup"/>		
<input type="checkbox"/> Snapshot	<input type="button" value="Setup"/>		
<input type="checkbox"/> Voice Prompts	File Name None		
<input type="checkbox"/> Show Message	<input type="checkbox"/> Send Email <input type="checkbox"/> Buzzer <input type="checkbox"/> Message <input checked="" type="checkbox"/> Log		
<input checked="" type="checkbox"/> Alarm Upload			
<input type="button" value="Copy"/> <input type="button" value="Save"/> <input type="button" value="Refresh"/> <input type="button" value="Default"/>			

Figure 5-63

5.10.3.1.3 Tampering

The tampering interface is shown as in Figure 5-64.

After analysis video, system can generate a tampering alarm when the detected moving signal reached the sensitivity you set here.

For detailed setups, please refer to chapter 5.10.3.1.1 motion detect for detailed information.

Motion Detect	Video Loss	Tampering	Diagnosis
<input checked="" type="checkbox"/> Enable	1		
Period	Setup		
Sensitivity	3		
<input checked="" type="checkbox"/> Record Channel	Setup		
Delay	10 sec. (10-300)		
<input checked="" type="checkbox"/> Alarm Out	1 2 3		
Latch	10 sec. (0~300)		
<input type="checkbox"/> PTZ Activation	Setup		
<input type="checkbox"/> Tour	Setup		
<input type="checkbox"/> Snapshot	Setup		
<input type="checkbox"/> Voice Prompts	File Name	None	
<input type="checkbox"/> Show Message	<input type="checkbox"/> Send Email	<input type="checkbox"/> Buzzer	<input type="checkbox"/> Message <input checked="" type="checkbox"/> Log
<input checked="" type="checkbox"/> Alarm Upload			
Copy Save Refresh Default			

Figure 5-64

5.10.3.1.4 Diagnosis

System can trigger an alarm when the stripe, noise, color cast, out of focus, over exposure event occurred. See Figure 5-65.

Motion Detect	Video Loss	Tampering	Diagnosis
Channel	1	Set	
<input checked="" type="checkbox"/> Enable			
Period	Set		
<input type="checkbox"/> Alarm Out	1 2 3		
Latch	10 sec. (0~300)		
<input type="checkbox"/> Voice Prompts	File Name	None	
<input type="checkbox"/> Send Email	<input checked="" type="checkbox"/> Buzzer	<input type="checkbox"/> Message	<input checked="" type="checkbox"/> Log
Save Refresh Default			

Figure 5-65

Click Set button, you can check the corresponding box to select diagnosis type. See Figure 5-66.

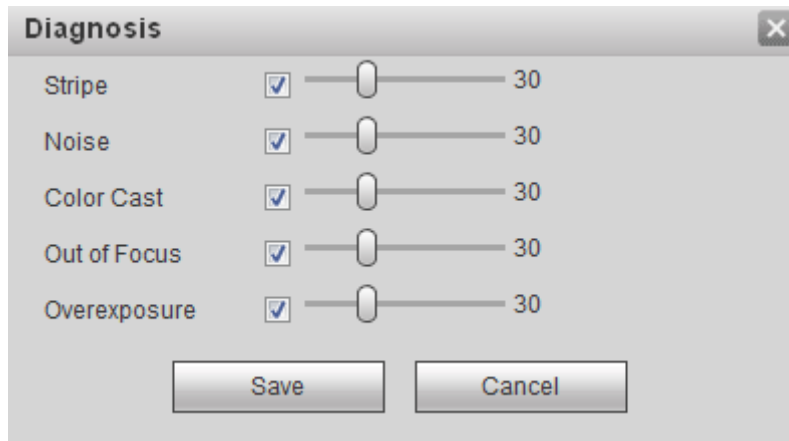

Figure 5-66

 **Note**

Video diagnosis alarm can trigger PTZ preset, tour, and pattern.

For detailed setups, please refer to chapter 5.10.3.1.1 motion detect for detailed information.

5.10.3.2 IVS (Optional)

 **Note**

Right now, the IVS function max supports 10 rules.

Once any object violate the rule, the DVR can trigger an alarm and alert you as the specified alarm mode.

From main menu->Setup->Event->IVS, enter IVS interface. See Figure 5-67.

Please follow the steps listed below.

- Step 1 Please select a channel from the dropdown list.
- Step 2 Click  and then select corresponding rule.
- Step 3 Set rule type and set corresponding parameters.
- Step 4 Check the box to enable the rule.
- Step 5 Click OK button to save current setup.

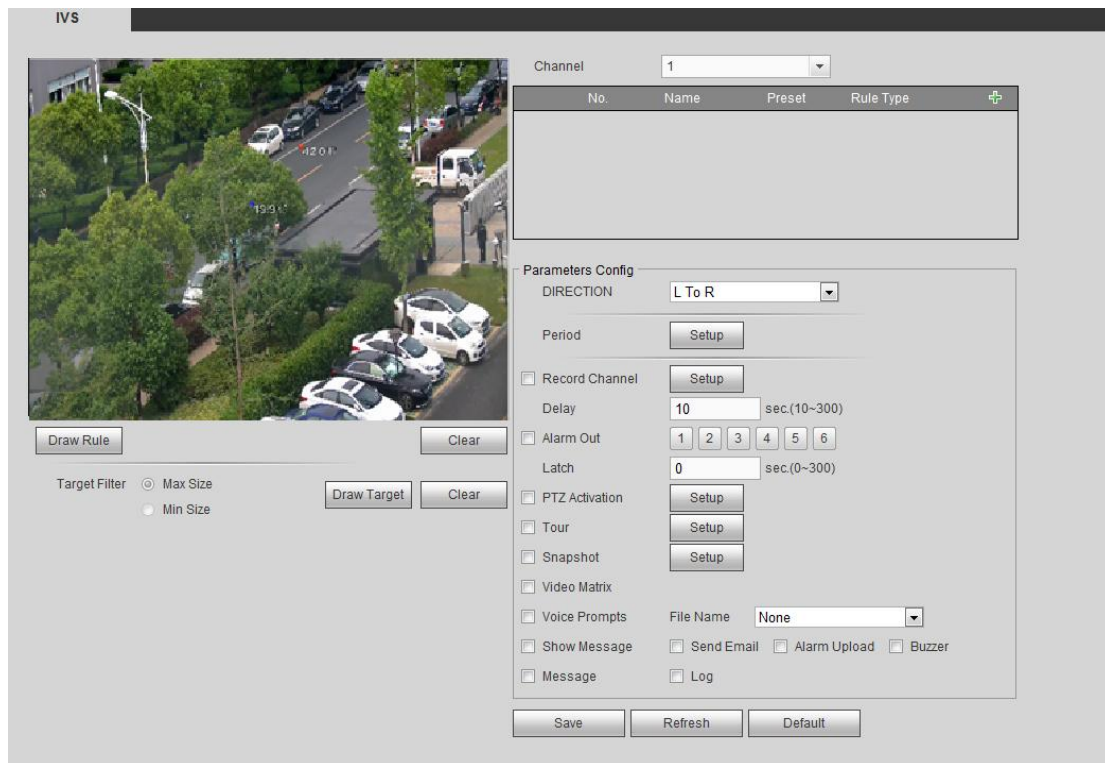



Figure 5-67

5.10.3.2.1 Tripwire

System generates an alarm once there is any object crossing the tripwire in the specified direction. Please use according to your actual situation.

Note

- The tripwire function is valid once your connected network camera or your DVR supports this function.
- If you want to use the IVS function of the network camera, please make sure your connected network camera supports this function.

Step 1 From main menu->Setup->Event->IVS->Tripwire, click  to add the rule and select the rule type as Tripwire.

Note

Double click to change a rule name.

Step 2 Check the Tripwire box to enable tripwire function. See Figure 5-68.

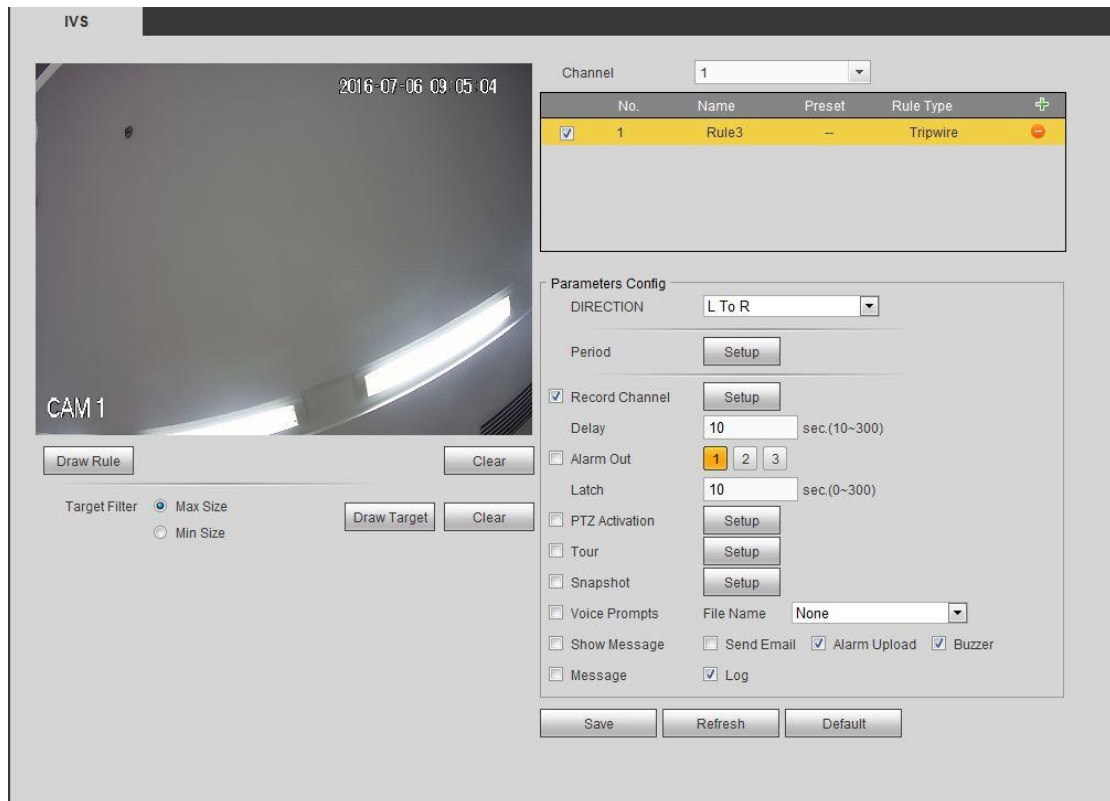

Figure 5-68

Step 3 Click Draw rule button and then left click mouse to draw a tripwire. Right click mouse to complete. See Figure 5-69.

 **Note**

The tripwire can be a direct line, curve or polygon.

Click Clear to delete the tripwire.

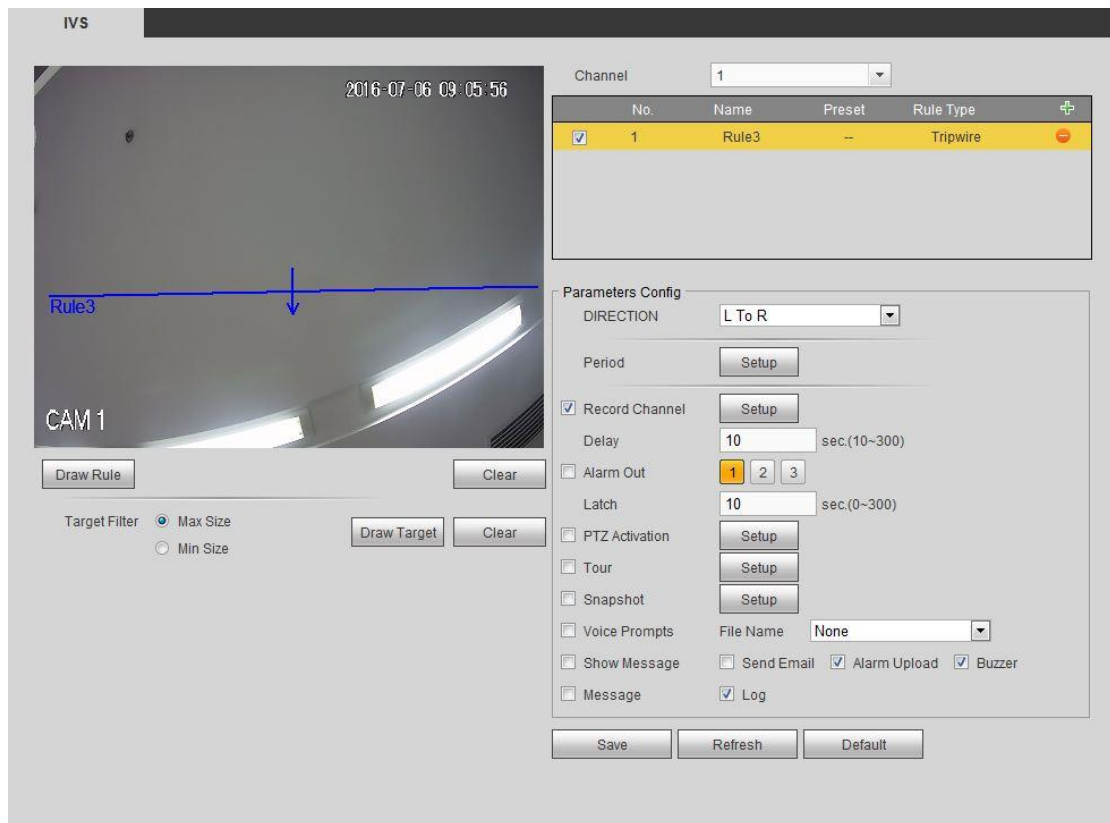

Figure 5-69

Step 4 Set filter object. Once the object is smaller than the min size or larger than the max size, there is no alarm.

1. After draw the rule, set max size and min size.
2. Click Draw target to draw the rectangle zone.

 **Note**

- Each rule can set two sizes (min size/max size). Please make sure the max size is larger than the min size.
- The default max size is the full screen, you can select the blue line and then use mouse to adjust.

Step 5 Set parameters.

Parameter	Function
Direction	Tripwire direction includes: A→B, B→A, A↔B.
Period	Set tripwire valid period. System generates an alarm during the specified period. For detailed setups, please refer to chapter 5.10.3.1.1 motion detect

Step 6 Click Save to complete setup.

5.10.3.2.2 Intrusion (Cross warning zone)

This function is to detect there is any object enter or exit the zone. Please use according to your actual situation.

 **Note:**

- The intrusion function is valid once your network camera or your DVR supports this function.
- If you want to use the IVS function of the network camera, please make sure your connected network camera supports this function.

Step 1 From main menu->Setup->Event->IVS, click  to add the rule. Select rule type as intrusion.

 **Note**

Double click to change a rule name.

Step 2 Check the box to enable Intrusion function. See Figure 5-70.

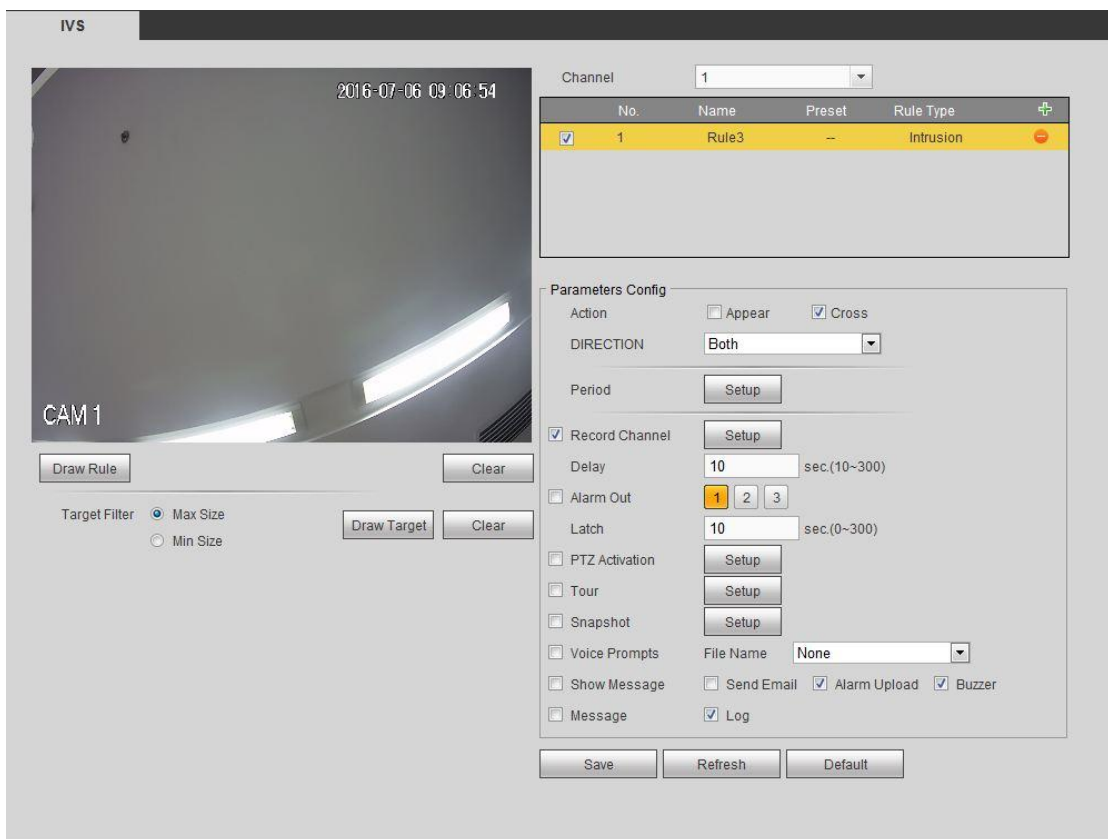

Figure 5-70

Step 3 Click Draw rule button and then left click mouse to draw an intrusion rule. Right click mouse to complete. See Figure 5-71.

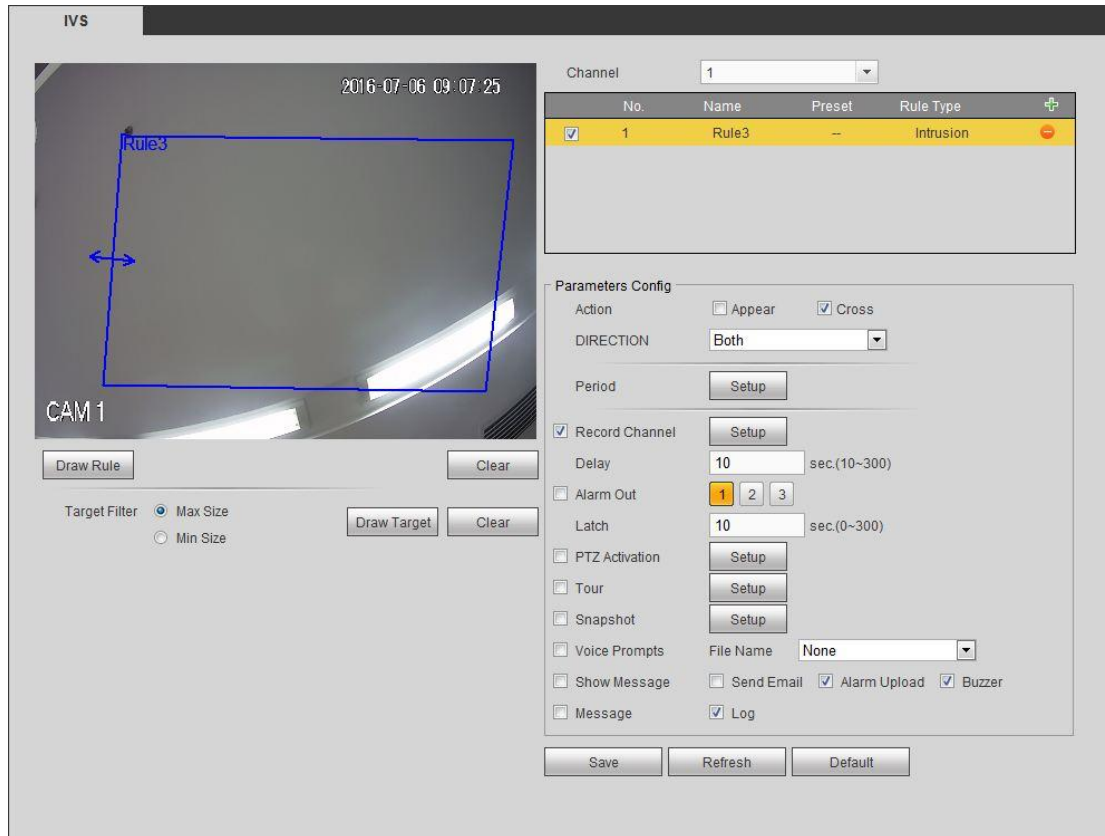

Figure 5-71

Step 4 Set filter object. Once the object is smaller than the min size or larger than the max size, there is no alarm.

1. After draw the rule, set max size and min size.
2. Click Draw target to draw the rectangle zone.

 **Note**

- Each rule can set two sizes (min size/max size). Please make sure the max size is larger than the min size.
- The default max size is the full screen, you can select the blue line and then use mouse to adjust.

Step 5 Set parameters.

Parameter	Function
Action	It is to set intrusion mode. <ul style="list-style-type: none"> ● Cross: It includes enter the warning zone, leave the warning zone or cross the warning zone. ● Appear: An object falling from nowhere (such as from the sky). It may not fully enter the warning zone.
Direction	When the action mode is cross, there are three options: A->B, B->A, both. System can generate an alarm once there is any object enter/exit (Or both) the zone.

Parameter	Function
Period	Set tripwire valid period. System generates an alarm during the specified period. For detailed setups, please refer to chapter 5.10.3.1.1 motion detect.

Step 6 Click Save to complete setup.

5.10.3.2.3 Abandoned Object Detect

It is to detect there is any abandoned object in the surveillance area for the specified time.

Note:

- The abandoned object detection function is valid once your network camera or your DVR supports this function.
- If you want to use the IVS function of the network camera, please make sure your connected network camera supports this function.

Step 1 From main menu->Setup->Event->IVS, click  to add the rule. Select rule type as abandoned object detection.

Note

Double click to change a rule name.

Step 2 Check the box to enable abandoned object detection function. See Figure 5-72.

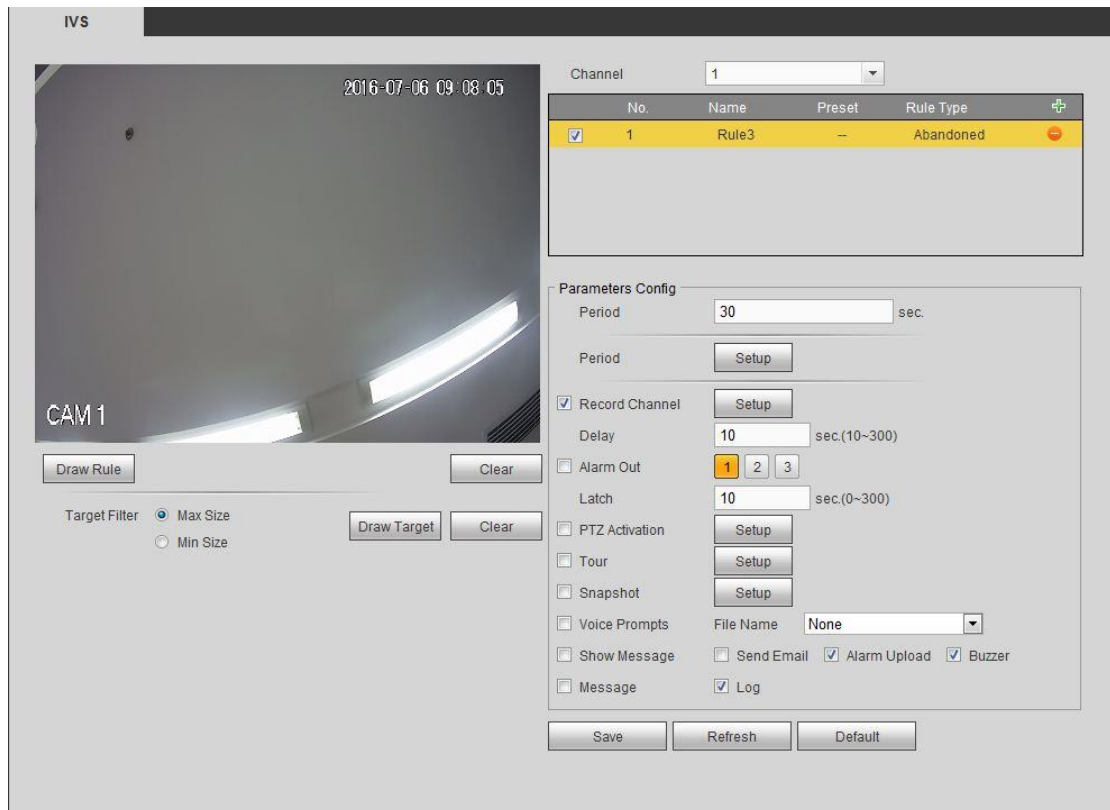

Figure 5-72

Step 3 Click Draw rule to draw the rule. See Figure 5-73. Left click mouse to draw a line, until you draw a rectangle, you can right click mouse.

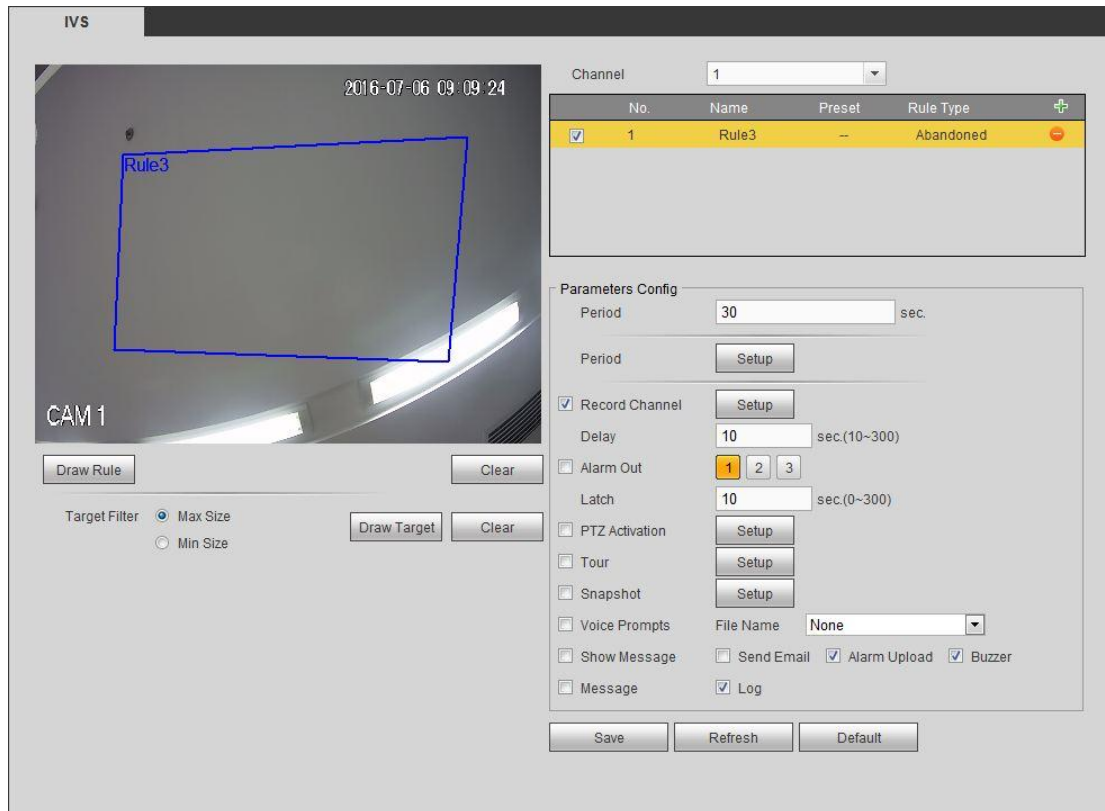

Figure 5-73

Step 4 Set filter object. Once the object is smaller than the min size or larger than the max size, there is no alarm.

1. After draw the rule, set max size and min size.
2. Click Draw target to draw the rectangle zone.

 **Note**

- Each rule can set two sizes (min size/max size). Please make sure the max size is larger than the min size.
- The default max size is the full screen, you can select the blue line and then use mouse to adjust.

Step 5 Set parameters.

Parameter	Function
Lasting Period	It refers to the time that object is staying in the zone time.
Period	Set tripwire valid period. System generates an alarm during the specified period. For detailed setups, please refer to chapter 5.10.3.1.1 motion detect

Step 6 Click Save to complete setup.

5.10.3.2.4 Missing Object Detect

It is to detect there is any abandoned object in the surveillance area for the specified time.

- System supports customized area shape and amount.
- Support period setup.

- Support objects filter function.

 **Note:**

- The missing object detection function is valid once your network camera or your DVR supports this function.
- If you want to use the IVS function of the network camera, please make sure your connected network camera supports this function.

Step 1 From main menu->Setup->Event->IVS, click  to add the rule and select the rule type as missing object detection.

 **Note**

Double click to change a rule name.

Step 2 Check the missing object detection to enable missing object detection function. See Figure 5-74.

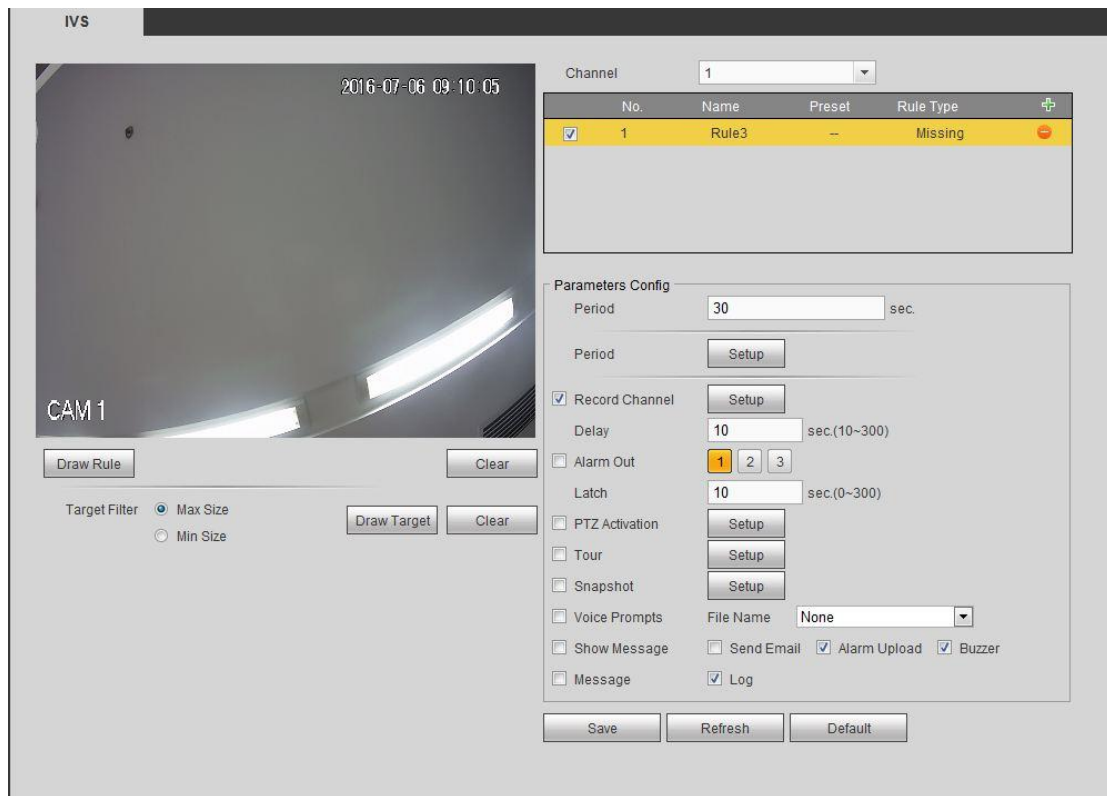

Figure 5-74

Step 3 Click Draw rule button and then left click mouse to draw a zone. Right click mouse to complete. See Figure 5-75.

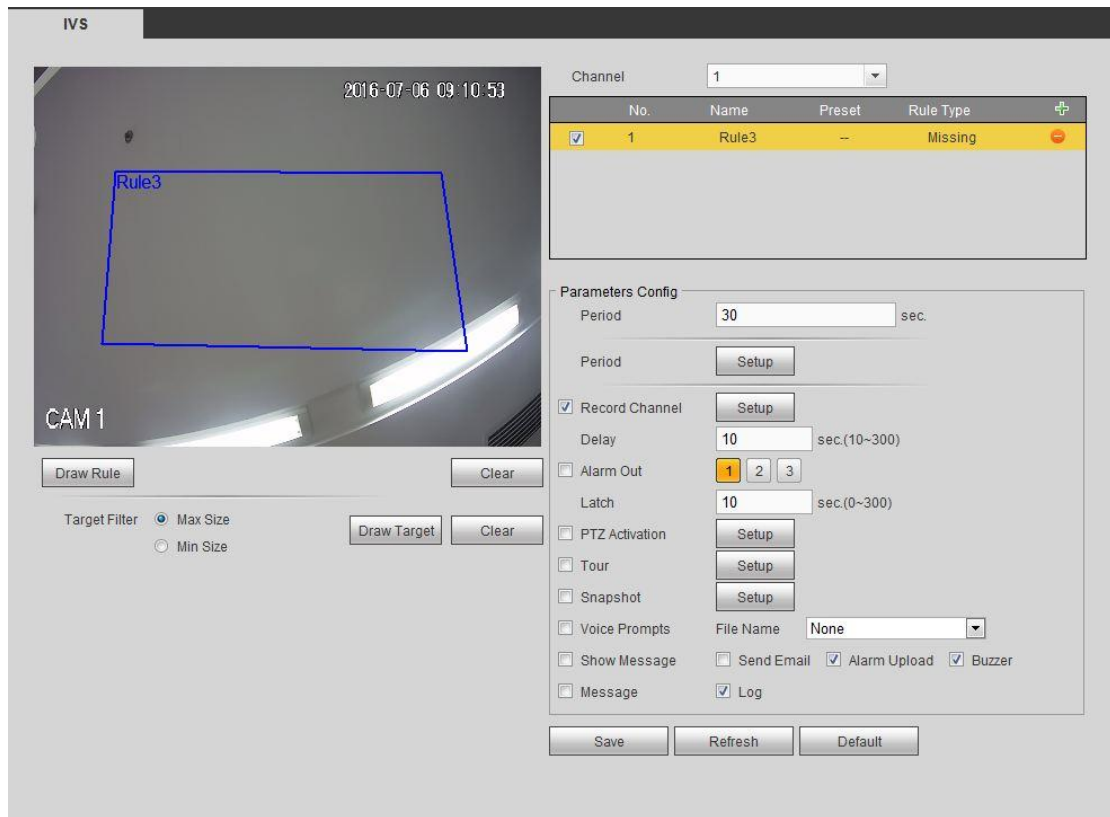

Figure 5-75

Step 4 Set filter object. Once the object is smaller than the min size or larger than the max size, there is no alarm.

1. After draw the rule, set max size and min size.
2. Click Draw target to draw the rectangle zone.

 **Note**

- Each rule can set two sizes (min size/max size). Please make sure the max size is larger than the min size.
- The default max size is the full screen, you can select the blue line and then use mouse to adjust.

Step 5 Set parameters.

Parameter	Function
Lasting Period	It refers to the time that object is staying in the zone time.
Period	Set tripwire valid period. System generates an alarm during the specified period. For detailed setups, please refer to chapter 5.10.3.1.1 motion detect

Step 6 Click Save to complete setup.

5.10.3.3 Alarm

Before operation, please make sure you have properly connected alarm devices such as buzzer. The input mode includes local alarm and network alarm.

5.10.3.3.1 Local Alarm

The local alarm interface is shown as in Figure 5-76. It refers to alarm from the local

device.

The screenshot shows a configuration window for a 'Local Alarm'. It features several tabs: 'Local Alarm', 'IPC External Alarm', 'IPC Offline Alarm', and 'Alarm Box'. The 'Local Alarm' tab is active. The interface includes the following elements:

- Enable: A dropdown menu showing the value '1'.
- Alarm Name: A text input field containing 'Alarm In1'.
- Period: A 'Set' button.
- Anti-dither: A text input field with '5' and the label 'sec. (0-600)'. To its right is a 'Type' dropdown menu set to 'NO'.
- Record Channel: A 'Set' button.
- Delay: A text input field with '10' and the label 'sec. (10-300)'.
- Alarm Out: A 'Set' button.
- Latch: A text input field with '10' and the label 'sec. (0~300)'.
- PTZ Activation: A 'Set' button.
- Tour: A 'Set' button.
- Snapshot: A 'Set' button.
- Video Matrix.
- Voice Prompts: A 'File Name' dropdown menu set to 'None'.
- Show Message: Three checkboxes for 'Send Email', 'Buzzer', and 'Log', all of which are currently unchecked.
- Alarm Upload.

At the bottom of the window are four buttons: 'Copy', 'Save', 'Refresh', and 'Default'.

Figure 5-76

The screenshot shows a 'Setup' dialog box with a close button (X) in the top right corner. It contains a dropdown menu set to 'Thursday' and a 'Copy' button. Below these are six rows of time selection controls, each consisting of a checkbox, a time range input (HH : MM - HH : MM), and a 'Copy' button. The first row has a checked checkbox and the time range '00 : 00 - 24 : 00'. The other five rows have unchecked checkboxes and the same time range. At the bottom of the dialog are 'Save' and 'Cancel' buttons.

Figure 5-77

The image shows a 'PTZ Activation' dialog box. It contains a list of 8 channels. Each channel has a dropdown menu currently set to 'None' and a numeric input field set to '0'. At the bottom of the dialog are two buttons: 'Save' and 'Cancel'.

Channel	Dropdown	Value
Channel 1	None	0
Channel 2	None	0
Channel 3	None	0
Channel 4	None	0
Channel 5	None	0
Channel 6	None	0
Channel 7	None	0
Channel 8	None	0

Figure 5-78

Please refer to the following sheet for detailed information.

Parameter	Function
Enable	You need to check the box to enable this function. Please select a channel from the dropdown list.
Period	This function becomes activated in the specified periods. There are six periods in one day. Please draw a circle to enable corresponding period. Select date. If you do not select, current setup applies to today only. You can select all week column to apply to the whole week. Click OK button, system goes back to local alarm interface, please click save button to exit.
Anti-dither	System only memorizes one event during the anti-dither period. The value ranges from 5s to 600s.
Sensor type	There are two options: NO/NC.
Record channel	System auto activates motion detection channel(s) to record once an alarm occurs. Please note you need to set alarm record period and go to Storage-> Schedule to set current channel as schedule record.
Record Delay	System can delay the record for specified time after alarm ended. The value ranges from 10s to 300s.
Alarm out	Enable alarm activation function. You need to select alarm output port so that system can activate corresponding alarm device when an alarm occurs.
Latch	System can delay the alarm output for specified time after an alarm ended. The value ranges from 1s to 300s.
Show message	System can pop up a message to alarm you in the local host screen if you enabled this function.

Parameter	Function
Buzzer	Check the box here to enable this function. The buzzer beeps when an alarm occurs.
Alarm upload	System can upload the alarm signal to the center (Including alarm center).
Send Email	If you enabled this function, System can send out an email to alert you when an alarm occurs.
Tour	You need to check the box here to enable this function. System begins 1-window or multiple-window tour display among the channel(s) you set to record when an alarm occurs.
PTZ Activation	Here you can set PTZ movement when an alarm occurs. Such as go to preset X.
Log	Check the box here, system can record local alarm event log.

5.10.3.3.2 HDCVI Alarm

The HDCVI alarm interface is shown as in Figure 5-79.

HDCVI alarm refers to the camera receive the camera voltage, motion detect and external alarm. It can set alarm activation operations. This function is null if the camera does not support alarm function. For setup information, please refer to chapter 5.10.3.3.1.

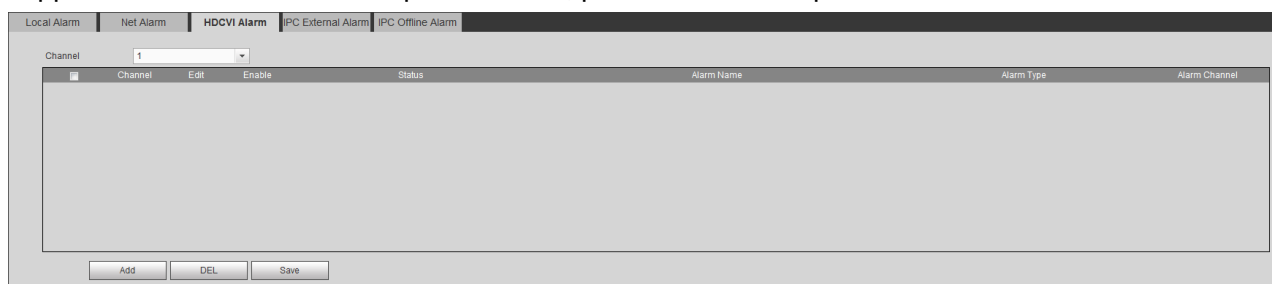

Figure 5-79

5.10.3.3.3 IPC External Alarm

IPC external alarm interface is shown as below. See Figure 5-80. For setup information, please refer to chapter 5.10.3.3.1.

Local Alarm	IPC External Alarm	IPC Offline Alarm	Alarm Box
<input type="checkbox"/> Channel	<input type="text"/>	Alarm Name	<input type="text" value="Alarm In1"/>
Period	<input type="button" value="Set"/>		
Anti-dither	<input type="text" value="5"/> sec. (0-600)	Type	<input type="text" value="NO"/>
<input checked="" type="checkbox"/> Record Channel	<input type="button" value="Set"/>		
Delay	<input type="text" value="10"/> sec. (10-300)		
<input type="checkbox"/> Alarm Out	<input type="button" value="Set"/>		
Latch	<input type="text" value="10"/> sec. (0~300)		
<input type="checkbox"/> PTZ Activation	<input type="button" value="Set"/>		
<input type="checkbox"/> Tour	<input type="button" value="Set"/>		
<input type="checkbox"/> Snapshot	<input type="button" value="Set"/>		
<input type="checkbox"/> Video Matrix			
<input type="checkbox"/> Voice Prompts	File Name	<input type="text" value="None"/>	
<input type="checkbox"/> Show Message	<input type="checkbox"/> Send Email	<input type="checkbox"/> Buzzer	<input type="checkbox"/> Log
<input type="checkbox"/> Alarm Upload			
<input type="button" value="Copy"/> <input type="button" value="Save"/> <input type="button" value="Refresh"/> <input type="button" value="Default"/>			

Figure 5-80

5.10.3.3.4 IPC Offline Alarm

IPC offline alarm is shown as in Figure 5-81. For setup information, please refer to chapter 5.10.3.3.1.

Local Alarm	IPC External Alarm	IPC Offline Alarm	Alarm Box
<input type="checkbox"/> Channel	<input type="text"/>		
<input checked="" type="checkbox"/> Record Channel	<input type="button" value="Set"/>		
Delay	<input type="text" value="10"/> sec. (10-300)		
<input type="checkbox"/> Alarm Out	<input type="button" value="Set"/>		
Latch	<input type="text" value="10"/> sec. (0~300)		
<input type="checkbox"/> PTZ Activation	<input type="button" value="Set"/>		
<input type="checkbox"/> Tour	<input type="button" value="Set"/>		
<input type="checkbox"/> Snapshot	<input type="button" value="Set"/>		
<input type="checkbox"/> Video Matrix			
<input type="checkbox"/> Voice Prompts	File Name	<input type="text" value="None"/>	
<input type="checkbox"/> Show Message	<input type="checkbox"/> Send Email	<input type="checkbox"/> Buzzer	<input type="checkbox"/> Log
<input type="checkbox"/> Alarm Upload			
<input type="button" value="Copy"/> <input type="button" value="Save"/> <input type="button" value="Refresh"/> <input type="button" value="Default"/>			

Figure 5-81

5.10.3.3.5 Alarm Box

It refers to alarm signal from the connected peripheral alarm box. See Figure 5-82. For setup information, please refer to chapter 5.10.3.3.1.

The screenshot shows the 'Alarm Box' configuration window. It features a tabbed interface with 'Alarm Box' selected. The configuration includes a dropdown for 'Alarm Box', a checked 'Channel' checkbox with a dropdown, and a text field for 'Alarm Name' containing 'Alarm In1'. There are several 'Set' buttons for 'Period', 'Record Channel', 'Alarm Out', 'PTZ Activation', 'Tour', and 'Snapshot'. Numerical input fields are present for 'Anti-dither' (5), 'Delay' (10), and 'Latch' (10), each with a unit and range. A 'Type' dropdown is set to 'NO'. At the bottom, there are checkboxes for 'Send Email', 'Buzzer', and 'Log' (checked), and a 'File Name' dropdown set to 'None'. 'Save', 'Refresh', and 'Default' buttons are at the very bottom.

Figure 5-82

5.10.3.4 Face Detect (Optional)



The face detection function is optional. The intelligence function and the human face detection can not be valid at the same time!

When camera detects human face, system can draw a rectangle around the human face and generate an alarm.

From main menu->Setup->Event->Face detect, the interface is shown as in Figure 5-83.

- Enable face boost: Check the box here, system can enhance the human face display pane.
- Sensitivity: System supports 6 levels. The sixth level has the highest sensitivity.

For detailed setups, please refer to chapter 5.10.3.1.1.

FACE DETECT

Enable 22 ▾

Human Face ROI

Alarm Face No. 1 (1~35)

Period

Record Channel

Delay sec. (10~300)

Alarm Out 1 2 3 4 5 6

Latch sec. (0~300)

PTZ Activation

Tour

Snapshot

Voice Prompts File Name ▾

Send Email Buzzer Message Log

Figure 5-83

5.10.3.5 Abnormality

It includes four types: HDD/Network/User/Device. See Figure 5-84 through Figure 5-87.

- HDD includes: No disk, disk error, disk no space.
- Network includes net disconnection, IP conflict, and MAC conflict.
- User: It includes illegal login.
- Device: It includes device temperature alarm, fan alarm and etc.

HDD	Network	User
Event Type	No HDD	
<input checked="" type="checkbox"/> Enable		
<input checked="" type="checkbox"/> Alarm Out	1 2 3	
Latch	10 sec. (0~300)	
<input type="checkbox"/> Voice Prompts	File Name None	
<input checked="" type="checkbox"/> Show Message	<input type="checkbox"/> Send Email <input checked="" type="checkbox"/> Buzzer <input type="checkbox"/> Message <input checked="" type="checkbox"/> Log	
<input checked="" type="checkbox"/> Alarm Upload		
Save		Refresh

Figure 5-84

HDD	Network	User
Event Type	Disconnect	
<input checked="" type="checkbox"/> Enable		
<input checked="" type="checkbox"/> Alarm Out	1 2 3	
Latch	10 sec. (0~300)	
<input type="checkbox"/> Voice Prompts	File Name None	
<input type="checkbox"/> Show Message	<input type="checkbox"/> Send Email <input type="checkbox"/> Buzzer <input type="checkbox"/> Message <input checked="" type="checkbox"/> Log	
<input type="checkbox"/> Record Channel	Setup	
Delay	10 sec. (10-300)	
Save		Refresh

Figure 5-85

HDD	Network	User	Device
Event Type <input type="text" value="Illegal Login"/>			
<input checked="" type="checkbox"/> Enable			
Attempt(s)		<input type="text" value="5"/>	
Lock Time		<input type="text" value="5"/>	Min.
<input checked="" type="checkbox"/> Alarm Out		<input type="button" value="1"/> <input type="button" value="2"/> <input type="button" value="3"/> <input type="button" value="4"/> <input type="button" value="5"/> <input type="button" value="6"/>	
Latch		<input type="text" value="10"/>	Sec.(0~300)
<input type="checkbox"/> Voice Prompts		File Name	<input type="text" value="None"/>
<input type="checkbox"/> Send Email		<input type="checkbox"/> Buzzer	
<input type="checkbox"/> Message		<input checked="" type="checkbox"/> Log	
<input type="button" value="Save"/>		<input type="button" value="Refresh"/>	

Figure 5-86

HDD	Network	User	Device
Event Type <input type="text" value="High Temperature"/>			
Alarm Name <input type="text" value="Case Temperature"/>			
Max Temperature <input type="text" value="60"/> °C			
<input checked="" type="checkbox"/> Enable			
<input type="checkbox"/> Alarm Out		<input type="button" value="1"/> <input type="button" value="2"/> <input type="button" value="3"/> <input type="button" value="4"/> <input type="button" value="5"/> <input type="button" value="6"/>	
Latch		<input type="text" value="10"/>	Sec.(0~300)
<input type="checkbox"/> Voice Prompts		File Name	<input type="text" value="None"/>
<input type="checkbox"/> Show Message		<input type="checkbox"/> Send Email <input type="checkbox"/> Buzzer	
<input type="checkbox"/> Message		<input checked="" type="checkbox"/> Log	
<input type="button" value="Save"/>		<input type="button" value="Refresh"/>	

Figure 5-87

Please refer to the following sheet for detailed information.

Parameter	Function
Event Type	The abnormal events include: No disk, disk error, disk no space, net disconnection, IP conflict and MAC conflict. You can set one or more items here. Less than: You can set the minimum percentage value here (For disk not space only). The device can alarm when capacity is not sufficient. You need to draw a circle to enable this function.
Enable	Check the box here to enable selected function.
Alarm Out	Please select corresponding alarm output channel when an alarm occurs. You need to check the box to enable this function.
Latch	The alarm output can delay for the specified time after an alarm stops. T value ranges from 0s to 300s. The default setup is 10 seconds. The 0 second means there is no delaying time.
Attempt(s)	It is to set login attempt times. Once the login attempt exceeds the threshold you set here, current account will be locked. This function is for illegal login only.
Lock time	It is to set account lock time once its login attempt has exceeded the threshold you set. This function is for illegal login only.
High temperature	In Device interface (Figure 5-87), select High temperature from the dropdown list, and then input the max temperature. The value ranges from 30 °C ~ 90 °C . Device can trigger an alarm once the case temperature is higher than the value you set.
Fan speed abnormal	In Device interface (Figure 5-87), select Fan speed abnormal from the dropdown list, and then click the OK button after the Fan calibration. It can correct fan manually. Please note we recommend this function after you replaced or maintained the fan.
Show message	System can pop up a message to alarm you in the local host screen if you enabled this function.
Alarm upload	System can upload the alarm signal to the center (Including alarm center).
Send Email	If you enabled this function, System can send out an email to alert you when an alarm occurs.
Buzzer	Check the box here to enable this function. The buzzer beeps when an alarm occurs.
Log	Check the box here, system can record the network event alarm log.

5.10.3.6 Alarm Output

5.10.3.6.1 General Alarm

It is to set alarm output mode. See Figure 5-88.

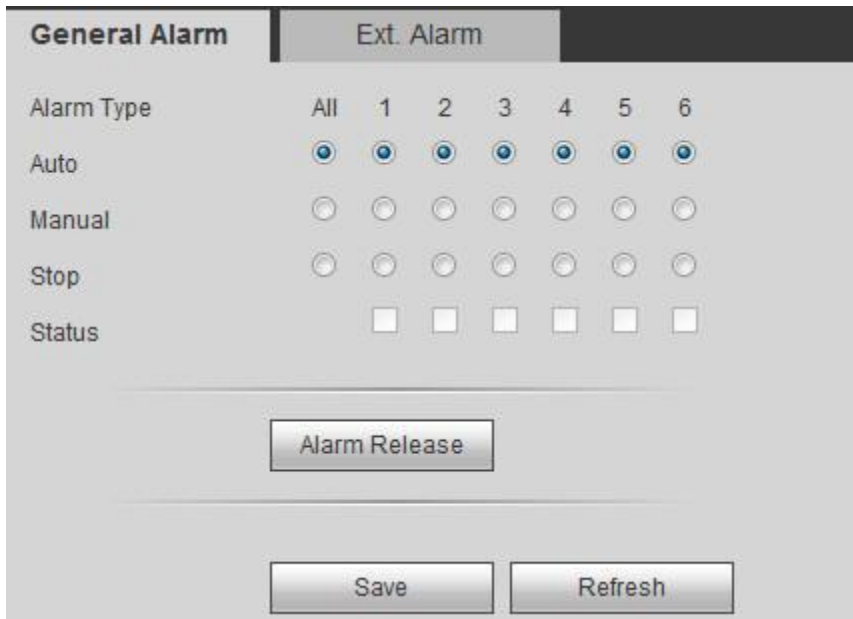

Figure 5-88

5.10.3.6.2 Extension alarm
 It is to reset alarm. See Figure 5-89.

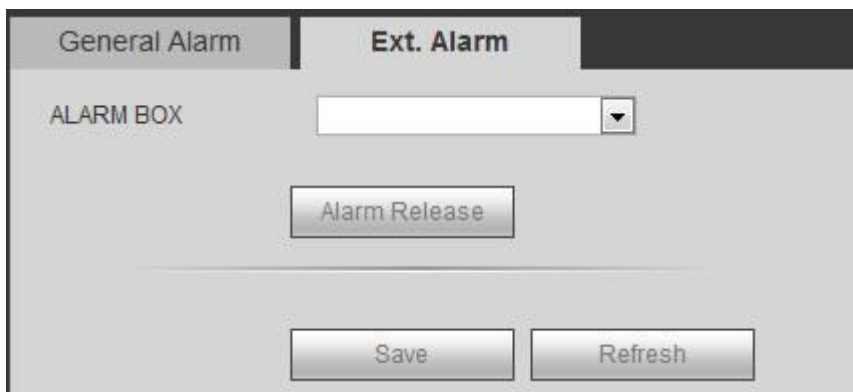

Figure 5-89

5.10.4 Storage

5.10.4.1 Basic

It is to manage HDD storage space.

Step 1 From main menu->Setup->Storage->Basic.

Enter Basic interface. See Figure 5-90.

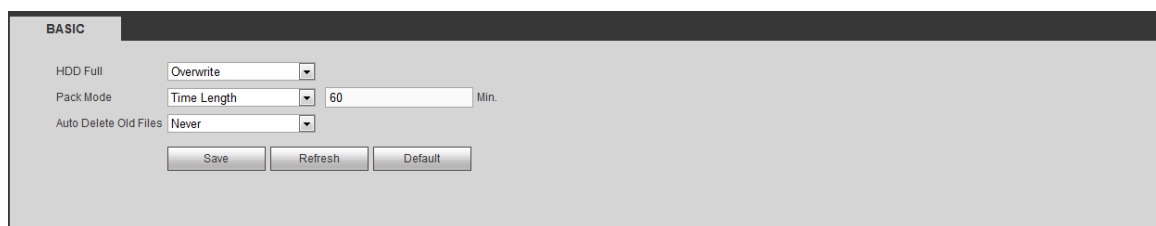



Figure 5-90

Step 2 Set parameters.

Parameter	Function
HDD full	<p>It is to select working mode when hard disk is full. There are two options: stop recording or rewrite.</p> <ul style="list-style-type: none"> ● Stop: If current HDD is full while there is no idle HDD, then system stops recording, ● Overwrite: If the current HDD is full while there is no idle HDD, then system overwrites the previous files. <p> Note</p> <p>DVR does not overwrite the locked files.</p>
Pack duration	<p>It is to specify record duration. There are two ways for you to set.</p> <ul style="list-style-type: none"> ● Time length: It is to pack according to time. The value ranges from 1 to 60 minutes. Default value is 60 minutes. ● File length: It is to pack according to file length. The default setup is 1024M. The value ranges from 128M to 2048M.
Auto delete old files	<ul style="list-style-type: none"> ● Never: Do not auto delete old files. ● Customized: input customized period here, system can auto delete corresponding old files. <p> Note</p> <p>The deleted file is not recoverable if you enable auto delete old files function</p>

5.10.4.2 Schedule

5.10.4.2.1 Schedule Record

In this interfaces, you can add or remove the schedule record setup. See Figure 5-91.

There are three record modes: general (auto), motion detect and alarm. There are six periods in one day.

You can view the current time period setup from the color bar.

- Green color stands for the general record/snapshot.
- Yellow color stands for the motion detect record/snapshot..
- Red color stands for the alarm record/snapshot.
- Blue color stands for MD&alarm record/snapshot.

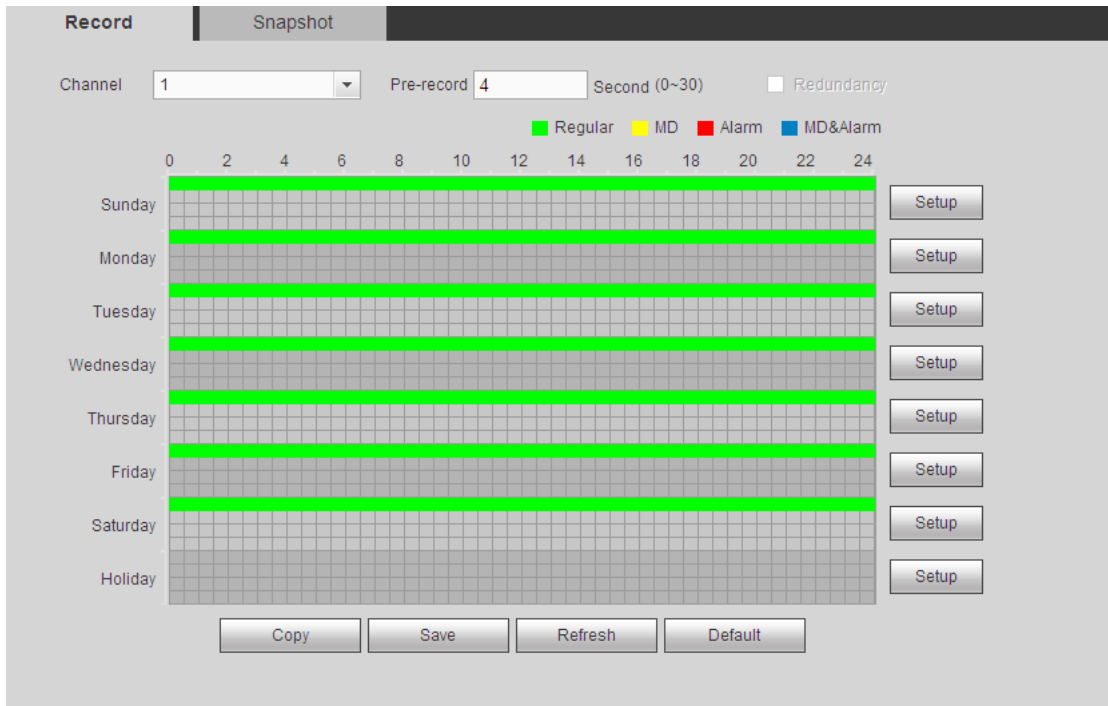

Figure 5-91

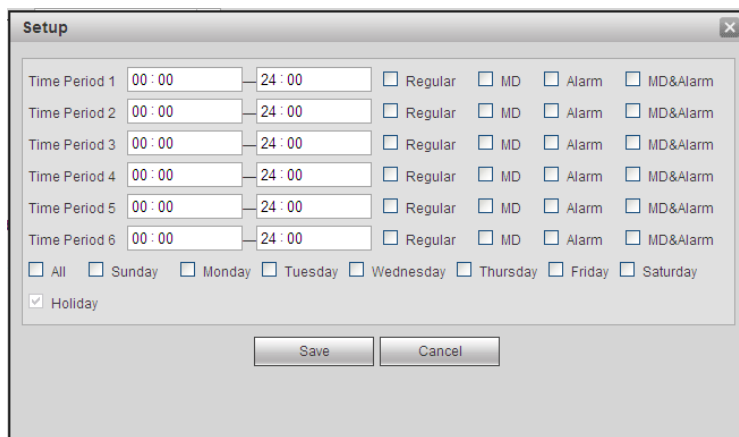

Figure 5-92

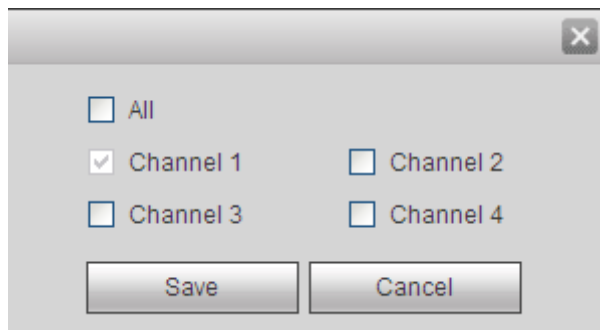

Figure 5-93

Please refer to the following sheet for detailed information.

Parameter	Function
Channel	Please select a channel from the dropdown list.
Pre-record	Please input pre-record time here. The value ranges from 0 to 30.
Redundancy	Check the box here to enable redundancy function. Please note this function is null if there is only one HDD.
Snapshot	Check the box here to enable snapshot function.
Holiday	Check the box here to enable holiday function.
Setup (Sunday to Saturday)	Click the Setup button, you can set record period. See Figure 5-92. There are six periods in one day. If you do not check the date at the bottom of the interface, current setup is for today only. Please click Save button and then exit.
Setup (Holiday)	Click the Setup button, you can set record period. See Figure 5-92. There are six periods in one day. If you check Holiday box, current channel shall record as your holiday setup here.
Copy	Copy function allows you to copy one channel setup to another. After setting in channel, click Copy button, you can go to interface Figure 5-93. You can see current channel name is grey such as channel 1. Now you can select the channel you want to paste such as channel 5/6/7. If you want to save current setup of channel 1 to all channels, you can click the first box "ALL". Click the OK button to save current copy setup. Click the OK button in the Encode interface, the copy function succeeded.

5.10.4.2.2 Schedule snapshot

The schedule snapshot interface is shown as below. See Figure 5-94.

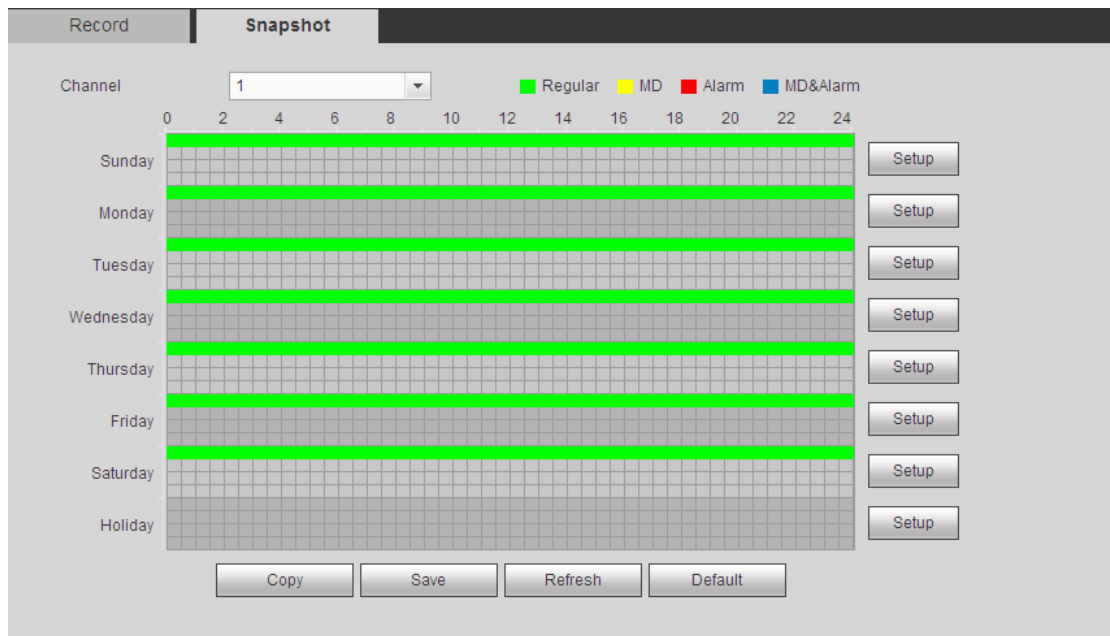

Figure 5-94

For detailed operation information, please refer to chapter 5.10.4.2.1.

5.10.4.3 HDD Manage

The interface is shown as in Figure 5-95. Here you can see HDD information. You can also operate the read-only, read-write, redundancy (if there are more than on HDD) and format operation.

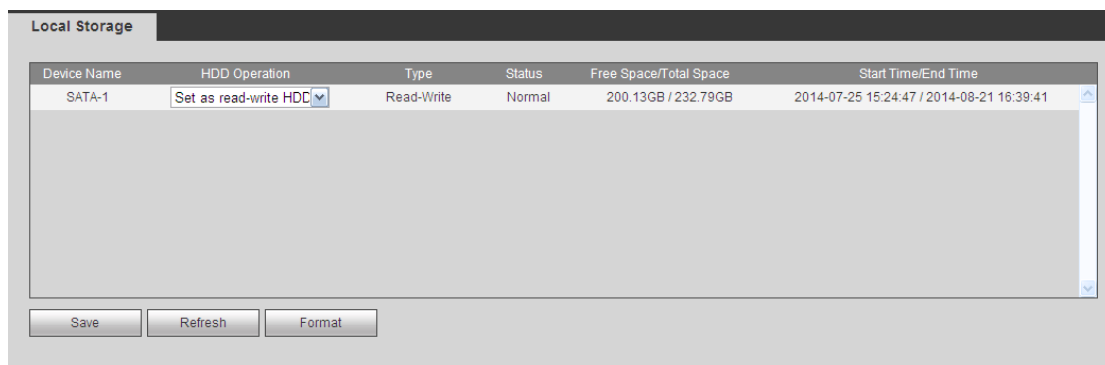

Figure 5-95

5.10.4.4 FTP

It is to backup record file or image to the FTP to storage or view.

Before the operation, please download or purchase the FTP service tool and install on the PC.



Note

For the FTP user, please set FTP folder write right, otherwise system cannot upload the image.

Step 1 From main window->Setup->Storage->FTP.

Enter FTP interface. See Figure 5-96.

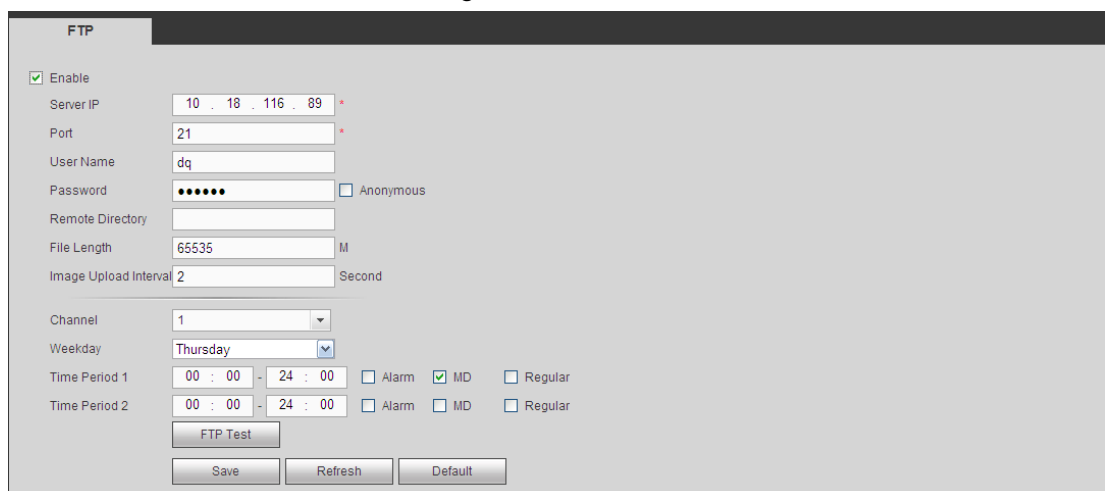

Figure 5-96

Step 2 Check the box to enable FTP function.



Note

SFTP is encryption transmission while FTP is not. We strongly recommend you use SFTP function.

Step 3 Set parameters.

Parameter	Function
Host IP	The host IP you have installed the FTP server.
Port	The SFTP port default value is 22 and the FTP port default value is 21.
User name/Password	The account for you to access the FTP server.
Remote directory	The folder you created under the root path of the FTP according to the corresponding rule. <ul style="list-style-type: none"> ● If there is no remote directory, system can auto create different directories according to the IP, time and channel. ● If there is remote directory, system can create corresponding folder under the FTP root path and then create different folders according to IP address, time and channel.
File length	File length is upload file length. When setup is larger than the actual file length, system will upload the whole file. When setup here is smaller than the actual file length, system only uploads the set length and auto ignore the left section. When interval value is 0, system uploads all corresponding files.
Image upload interval	It is the image upload interval. If the image upload interval is larger than the image snapshot frequency, system just uploads the lasted image. <ul style="list-style-type: none"> ● If the image interval is 5 seconds and the snapshot frequency is 2 seconds, system will send out the latest image at the buffer at 5 seconds. ● If the image upload interval is smaller than the snapshot frequency, system will upload at the snapshot frequency. For example, if the image interval is 5 seconds and the snapshot frequency is 10 seconds, system will send out the image at 10 seconds. ● From main menu->Setting->Camera->Encode->Snapshot to set snapshot frequency.
Channel	Select a channel from the dropdown list and then set week, period and record type.
Week day/Period	Please select from the dropdown list and for each day, you can set two periods.
Type	Please select uploaded record type (Alarm/intelligent/motion detect/regular). Please check the box to select upload type.

Step 4 Click Test.

- If the operation successful, device says FTP test successful.
- If the operation failed, device says FTP test failed. Please check network connection and settings.

Step 5 Click Save to complete the setup.

5.10.4.5 Manual Record

The interface is shown as in Figure 5-97.

Record																	
Main Stream	All	1	2	3	4	5	6	7	8	9	10	11	12	13	14	15	16
Auto	<input checked="" type="radio"/>	<input checked="" type="radio"/>	<input checked="" type="radio"/>	<input checked="" type="radio"/>	<input checked="" type="radio"/>	<input checked="" type="radio"/>	<input checked="" type="radio"/>	<input checked="" type="radio"/>	<input checked="" type="radio"/>	<input checked="" type="radio"/>	<input checked="" type="radio"/>	<input checked="" type="radio"/>	<input checked="" type="radio"/>	<input checked="" type="radio"/>	<input checked="" type="radio"/>	<input checked="" type="radio"/>	<input checked="" type="radio"/>
Manual	<input type="radio"/>	<input type="radio"/>	<input type="radio"/>	<input type="radio"/>	<input type="radio"/>	<input type="radio"/>	<input type="radio"/>	<input type="radio"/>	<input type="radio"/>	<input type="radio"/>	<input type="radio"/>	<input type="radio"/>	<input type="radio"/>	<input type="radio"/>	<input type="radio"/>	<input type="radio"/>	<input type="radio"/>
Stop	<input type="radio"/>	<input type="radio"/>	<input type="radio"/>	<input type="radio"/>	<input type="radio"/>	<input type="radio"/>	<input type="radio"/>	<input type="radio"/>	<input type="radio"/>	<input type="radio"/>	<input type="radio"/>	<input type="radio"/>	<input type="radio"/>	<input type="radio"/>	<input type="radio"/>	<input type="radio"/>	<input type="radio"/>
Sub Stream																	
Auto	<input type="radio"/>	<input type="radio"/>	<input type="radio"/>	<input type="radio"/>	<input type="radio"/>	<input type="radio"/>	<input type="radio"/>	<input type="radio"/>	<input type="radio"/>	<input type="radio"/>	<input type="radio"/>	<input type="radio"/>	<input type="radio"/>	<input type="radio"/>	<input type="radio"/>	<input type="radio"/>	<input type="radio"/>
Manual	<input type="radio"/>	<input type="radio"/>	<input type="radio"/>	<input type="radio"/>	<input type="radio"/>	<input type="radio"/>	<input type="radio"/>	<input type="radio"/>	<input type="radio"/>	<input type="radio"/>	<input type="radio"/>	<input type="radio"/>	<input type="radio"/>	<input type="radio"/>	<input type="radio"/>	<input type="radio"/>	<input type="radio"/>
Stop	<input checked="" type="radio"/>	<input checked="" type="radio"/>	<input checked="" type="radio"/>	<input checked="" type="radio"/>	<input checked="" type="radio"/>	<input checked="" type="radio"/>	<input checked="" type="radio"/>	<input checked="" type="radio"/>	<input checked="" type="radio"/>	<input checked="" type="radio"/>	<input checked="" type="radio"/>	<input checked="" type="radio"/>	<input checked="" type="radio"/>	<input checked="" type="radio"/>	<input checked="" type="radio"/>	<input checked="" type="radio"/>	<input checked="" type="radio"/>
Snapshot																	
Open	<input type="radio"/>	<input type="radio"/>	<input type="radio"/>	<input type="radio"/>	<input type="radio"/>	<input type="radio"/>	<input type="radio"/>	<input type="radio"/>	<input type="radio"/>	<input type="radio"/>	<input type="radio"/>	<input type="radio"/>	<input type="radio"/>	<input type="radio"/>	<input type="radio"/>	<input type="radio"/>	<input type="radio"/>
Stop	<input checked="" type="radio"/>	<input checked="" type="radio"/>	<input checked="" type="radio"/>	<input checked="" type="radio"/>	<input checked="" type="radio"/>	<input checked="" type="radio"/>	<input checked="" type="radio"/>	<input checked="" type="radio"/>	<input checked="" type="radio"/>	<input checked="" type="radio"/>	<input checked="" type="radio"/>	<input checked="" type="radio"/>	<input checked="" type="radio"/>	<input checked="" type="radio"/>	<input checked="" type="radio"/>	<input checked="" type="radio"/>	<input checked="" type="radio"/>
<input type="button" value="Save"/> <input type="button" value="Refresh"/>																	

Figure 5-97

Please refer to the following sheet for detailed information.

Parameter	Function
Channel	Here you can view channel number. The number displayed here is the max channel amount of your device.
Status	There are three statuses: schedule, manual and stop.
Schedule	System enables auto record function as you set in record schedule setup (general, motion detect and alarm).
Manual	It has the highest priority. Enable corresponding channel to record no matter what period applied in the record setup.
Stop	Stop current channel record no matter what period applied in the record setup.
Start all/ stop all	Check the corresponding All button, you can enable or disable all channels record.

5.10.4.6 Advanced

5.10.4.6.1 HDD

It is to set HDD group, and HDD group setup for main stream, sub stream and snapshot operation



CAUTION

HDD group and quota mode cannot be valid at the same time. System needs to restart once you change the mode here.

Step 1 From main menu->Setup->Storage->Advanced->HDD.
 Enter HDD interface. See Figure 5-98.

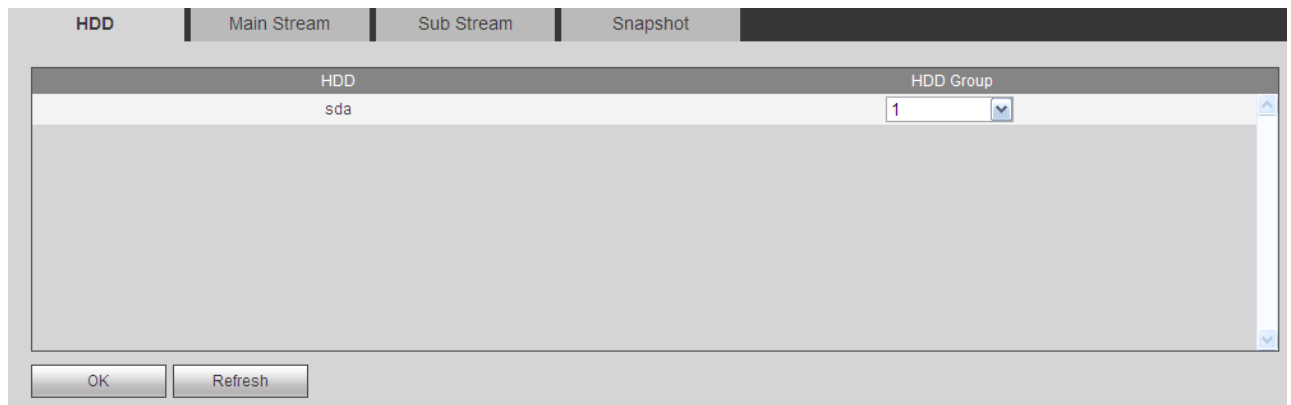

Figure 5-98

Step 2 Set a HDD group for current HDD.
 Click OK. Device begins reboot.

Step 3 After set HDD group, click main stream/sub stream/snapshot tab to save main stream, sub stream, snapshot image to different HDD group. See Figure 5-99, Figure 5-100, Figure 5-101

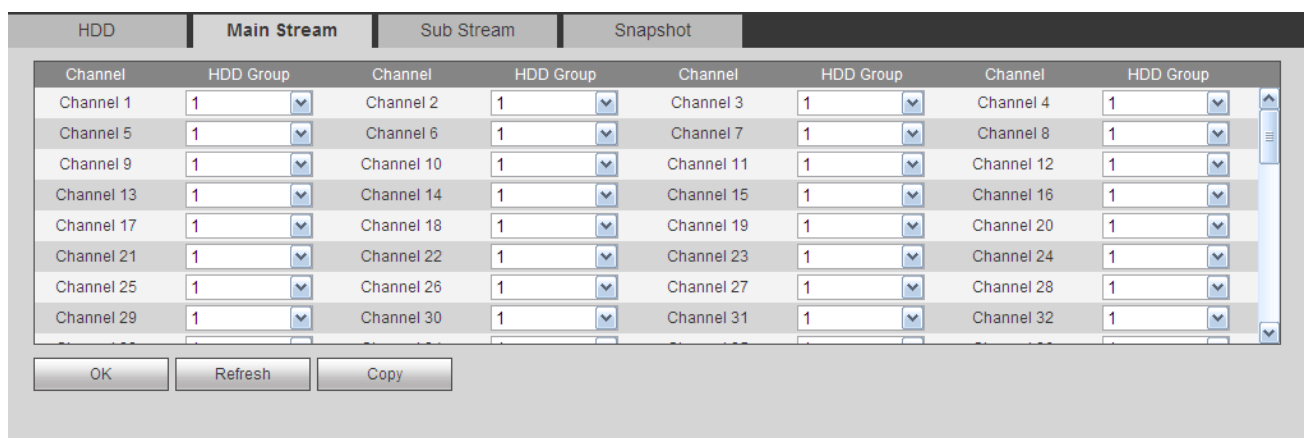

Figure 5-99

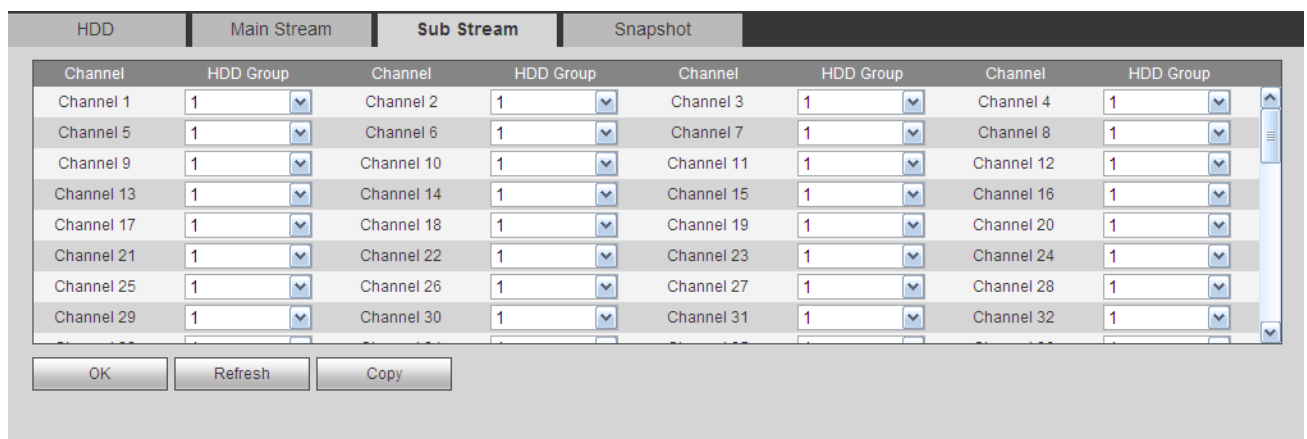

Figure 5-100

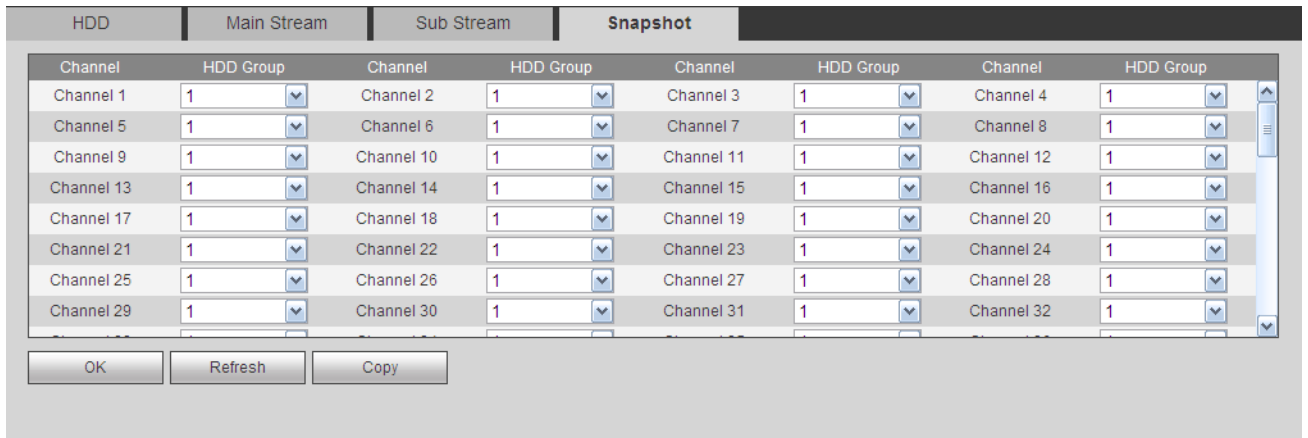

Figure 5-101

Step 4 Click Save to complete the setup.

5.10.4.7 Quota

It is to set channel storage capacity.



CAUTION

HDD group and quota mode cannot be valid at the same time. System needs to restart once you change the mode here.

Step 1 From main menu->Setup->Storage->Quota.

Enter quota interface. See Figure 5-102.

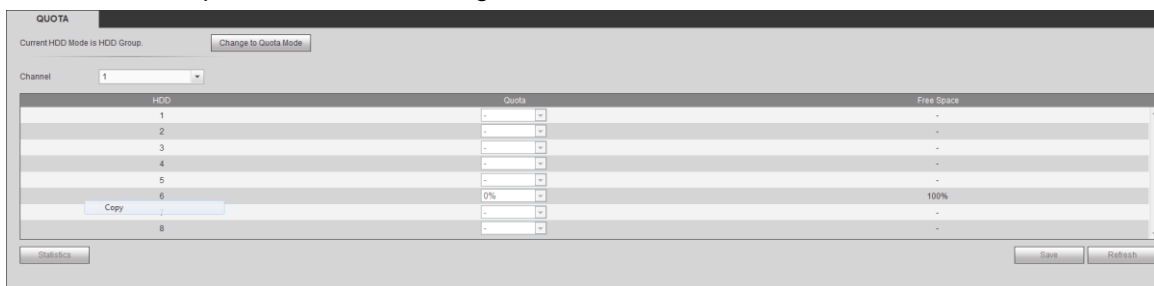

Figure 5-102

Step 2 Select a channel from the dropdown list and then select corresponding HDD quota.

Step 3 Click Apply or Save to complete setup.

Step 4 Click Statistics to view HDD capacity you set for each channel.

5.10.5 Setting

5.10.5.1 General

The general interface includes general, date/time and holiday setup.

5.10.5.1.1 General

The general interface is shown as in Figure 5-103.

The screenshot shows a configuration interface with the following fields and values:

- Device Name: XVR
- Device No.: 8
- Language: ENGLISH
- Video Standard: NTSC
- Auto Logout: 10 min. (0-60)
- Navigation Bar:
- IPC Time Sync: 24 h

Buttons: Save, Refresh, Default

Figure 5-103

Please refer to the following sheet for detailed information.

Parameter	Function
Device ID	It is to set device name.
Device No.	It is device channel number.
Language	You can select the language from the dropdown list. Please note the device needs to reboot to get the modification activated.
Video Standard	This is to display video standard such as PAL.
Auto logout	Here is for you to set auto logout interval once login user remains inactive for a specified time. Value ranges from 0 to 60 minutes.
IPC Time Sync	You can input an interval here to synchronize the DVR time and IPC time.
Navigation bar	Check the box here, system displays the navigation bar on the interface.

5.10.5.1.2 Date and time

The date and time interface is shown as in Figure 5-104.

General	Date&Time	Holiday
Date Format	YYYY MM DD	
Time Format	24-HOUR	
Date Separator	-	
Time Zone	GMT+08:00	
System Time	2016 - 01 - 12	17 : 13 : 50
	<input type="button" value="Sync PC"/>	
<input type="checkbox"/> DST		
DST Type	<input checked="" type="radio"/> Date <input type="radio"/> Week	
Begin Time	2000 - 01 - 01	00 : 00
End Time	2000 - 01 - 01	00 : 00
<input type="checkbox"/> NTP		
Server	time.windows.com	<input type="button" value="Manual Update"/>
Port	123	(1~65535)
Interval	60	min. (0~65535)
	<input type="button" value="Save"/>	<input type="button" value="Refresh"/>
	<input type="button" value="Default"/>	

Figure 5-104

Please refer to the following sheet for detailed information.

Parameter	Function
Date format	Here you can select date format from the dropdown list.
Time Format	There are two options: 24-H and 12-H.
Time zone	The time zone of the device.
System time	It is to set system time. It becomes valid after you set.
Sync PC	You can click this button to save the system time as your PC current time.
DST	Here you can set day night save time begin time and end time. You can set according to the date format or according to the week format.
NTP	Check the box to enable NTP function.
NTP server	Set the time server address. <ul style="list-style-type: none"> ● Check the NTP box to enable this function. ● Host IP: Input the server IP that installed the NTP server. ● Manual update: Click it, you can sync DVR time with the NTP server manually. ● Port: System supports TCP transmission only. The port value is 123. ● Interval: It is to set the sync time interval between the DVR and the NTP server. The value ranges from 0 to 65535 minutes.

Parameter	Function
Port	It is to set the time server port.
Interval	It is to set the sync periods between the device and the time server.

5.10.5.1.3 Holiday Setup

Holiday setup interface is shown as in Figure 5-105.

Here you can click Add box to add a new holiday and then click Save button to save.



Note

Once the holiday settings is different the general date, the holiday settings has priority. After successfully set holiday here, you can view holiday item in Schedule interface. It is for you to set holiday schedule record/snapshot settings.



Figure 5-105

5.10.5.2 Display

Display interface includes GUI, TV adjust, Tour and zero-channel encoding.

5.10.5.2.1 Display

Here you can set background color and transparency level. See Figure 5-106.

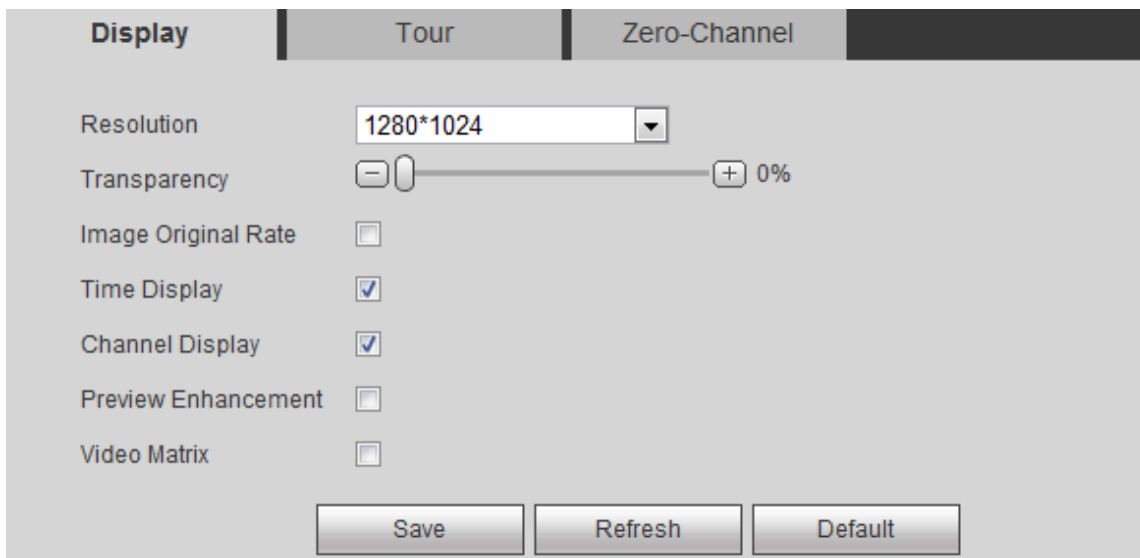

Figure 5-106

Please refer to the following sheet for detailed information.

Parameter	Function
Resolution	There are four options: 1920×1080, 1280×1024(default), 1280×720, 1024×768. Please note the system needs to reboot to activate current setup.
Transparency	Here is for you to adjust transparency. The value ranges from 128 to 255.
Time title/channel title	Check the box here, you can view system time and channel number on the monitor video.
Image enhance	Check the box; you can optimize the margin of the preview video.
IVS rule preview	Check the box here, you can view IVS rule name on the preview window.
Video matrix	<ul style="list-style-type: none"> ● Check the box, select VGA or the HDMI as the video matrix output. The selected screen(s) only display(s) the channel video from the video matrix. Refer to chapter 5.10.5.3 Video matrix for detailed information. ● Cancel the box, the VGA and HDMI output the same video.

5.10.5.2.2 TV Adjust



Note

This function is for some series product only.

It is to set TV output region. See Figure 5-107.

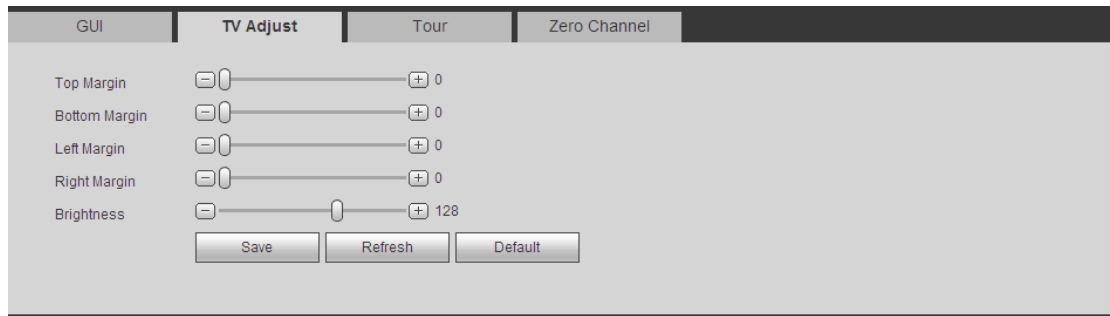

Figure 5-107

5.10.5.2.3 Tour

The tour interface is shown as in Figure 5-108. Here you can set tour interval, split mode, motion detect tour and alarm tour mode.

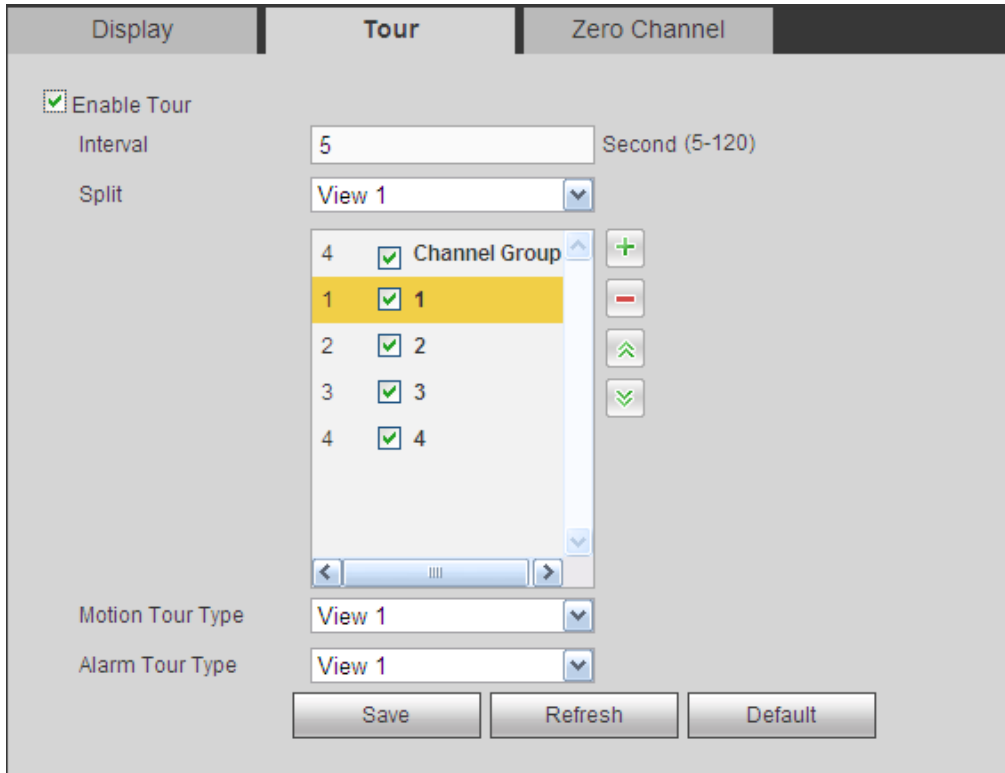

Figure 5-108

Please refer to the following sheet for detailed information.

Parameter	Function
Enable tour	Check the box here to enable tour function.
Interval	Here is for you to adjust transparency. The value ranges from 5 to 120s. The default setup is 5s.
Split	Here you can set window mode and channel group. System can support 1/4/8/9/16/25/36-window according to device channel amount.
Motion tour/Alarm tour	Here you can set motion detect tour/alarm tour window mode. System supports 1/8-window now.

5.10.5.2.4 Zero-channel Encoding

It is to enable and set zero-channel encoding function so that you can view several video sources at one channel from WEB.

The interface is shown as in Figure 5-109.

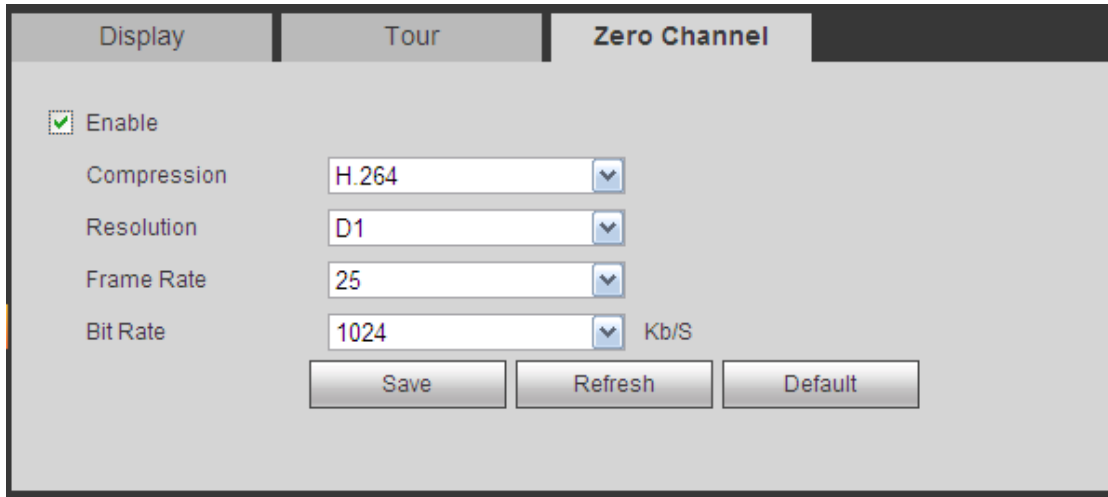

Figure 5-109

Please refer to the following sheet for detailed information.

Parameter	Function
Enable	This function is disabled by default. Check the box here to enable this function so that you can control the zero-channel encoding function at the WEB.
Compression	System default setup is H.264. You can set according to device capability.
Resolution	The resolution value may vary due to different device capabilities. Please select from the dropdown list.
Frame rate	The frame rate value may vary due to different device capabilities. Please select from the dropdown list.
Bit Rate	The default setup is 1024Kb/S. The bit rate value may vary due to different device capabilities and frame rate setups. Please select from the dropdown list.

5.10.5.3 Video Matrix

The interface is shown as in Figure 5-110.

Here you can set video output channel and interval.

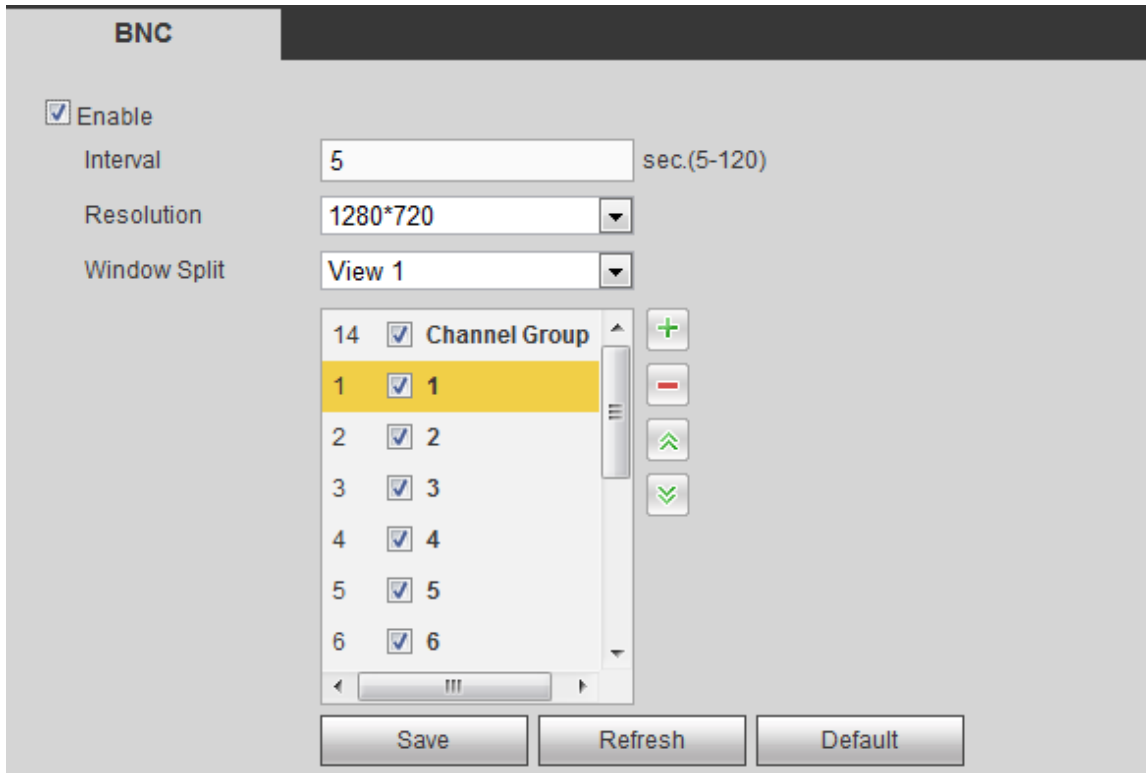





Figure 5-110

Please refer to the following sheet for detailed information.

Parameter	Function
Enable	Check the box here to enable this function.
Interval	It is to set the interval from current channel group to the next channel group.
Window split	Support 1-window split only.
Delete	Select a channel group and then click  to delete it.
Up/Down	Click  or  to adjust channel tour sequence.

Add channel group



Click , you can see system pops up the following dialogue box. See Figure 5-111. Please select the channels and then click OK button.



Figure 5-111

Delete channel group

Select a channel group and then click , you can delete it.



Modify channel group

Select a channel group and then double click, you can see the following interface. See Figure 5-112. You can change the setup and then click OK button.



Figure 5-112

Adjust channel group sequence.

Click  or  to change channel sequence.

5.10.5.4 RS232

Note

This function is for some series product only.

The RS232 interface is shown as in Figure 5-113.

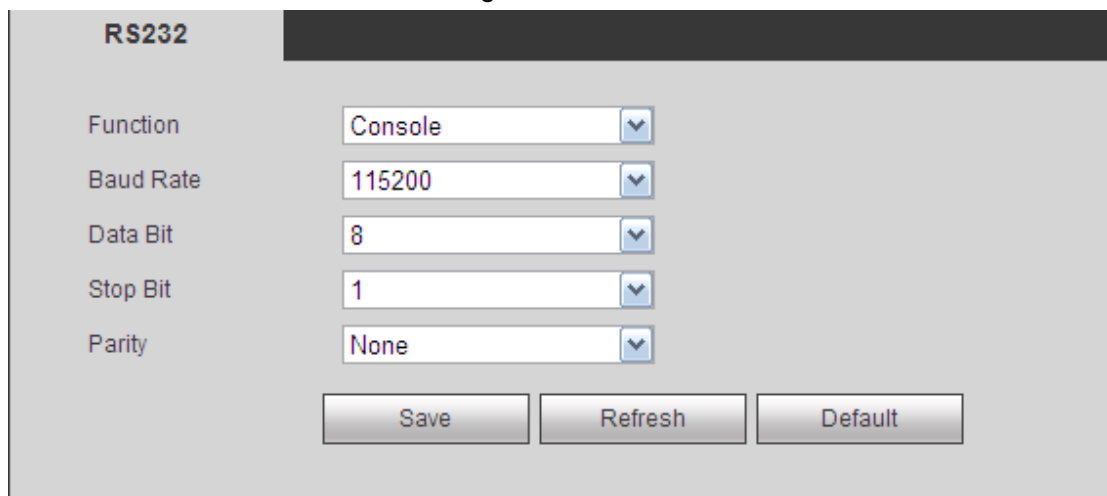

Figure 5-113

Please refer to the following sheet for detailed information.

Parameter	Function
Protocol	Select the corresponding dome protocol. Default setup is console.
Baud Rate	Select the baud rate. Default setup is 115200.
Data Bit	The value ranges from 5 to 8. Default setup is 8.

Parameter	Function
Stop bit	There are two options: 1/2. Default setup is 1.
Parity	There are five options: none/odd/even/space/mark. Default setup is none.

5.10.5.5 PTZ

The PTZ interface is shown as in Figure 5-114 and Figure 5-115.

Before setup, please check the following connections are right:

- PTZ and decoder connection is right. Decoder address setup is right.
- Decoder A (B) line connects with DVR A (B) line.

Click Save button after you complete setup, you can go back to the monitor interface to control speed dome.

PTZ

Channel: 1

PTZ Type: Local

Control Mode: Serial

Protocol: HDCVI3.0

Address: 1

Baud Rate: 9600

Data Bit: 8

Stop Bit: 1

Parity: None

Copy Save Refresh Default

Figure 5-114

PTZ

Channel: 4

PTZ Type: Remote

Copy Save Refresh Default

Figure 5-115

Please refer to the following sheet for detailed information.

Parameter	Function
Channel	Select speed dome connected channel.

Parameter	Function
PTZ type	There are two types: local/remote. Please select local mode if you are connect RS485 cable to connect to the Speed dome (PTZ). Please select remote mode if you are connecting to the network PTZ camera.
Control mode	You can select control mode from the dropdown list. There are two options: Serial/HDCVI. For HDCVI series product, please select HDCVI. The control signal is sent to the PTZ via the coaxial cable. For the serial mode, the control signal is sent to the PTZ via the RS485 port.
Protocol	Please select protocol from the dropdown list. If the control mode is HDCVI, please select HDCVI protocol. The default setup is HDCVI3.0.
Address	Set corresponding dome address. Default value is 1. Please note your setup here shall comply with your dome address; otherwise you cannot control the speed dome.
Baud Rate	Select the dome baud rate. Default setup is 9600.
Data Bit	Default setup is 8. Please set according to the speed dome dial switch setup.
Stop bit	Default setup is 1. Please set according to the speed dome dial switch setup.
Parity	Default setup is none. Please set according to the speed dome dial switch setup.

5.10.5.6 Alarm box

It is to view the connected alarm box state. See Figure 5-116.

Alarm Box	Address	Status
1	0	
2	1	
3	2	
4	3	

Refresh

Figure 5-116

5.10.5.7 ATM/POS

The ATM/POS function is for financial areas. It includes Sniffer, information analysis and title overlay function. The Sniffer mode includes COM and network.

5.10.5.7.1 COM Type

The COM interface is shown as below. See Figure 5-117.

- Protocol: Please select from the dropdown list according to your actual situation.
- Overlay channel: Please select the channel you want to overlay the card number.

- Overlay mode: There are two options: preview and encode. Preview means overlay the card number in the local monitor video. Encode means overlay the card number in the record file.
- Overlay Position: Here you can select the proper overlay position from the dropdown list.

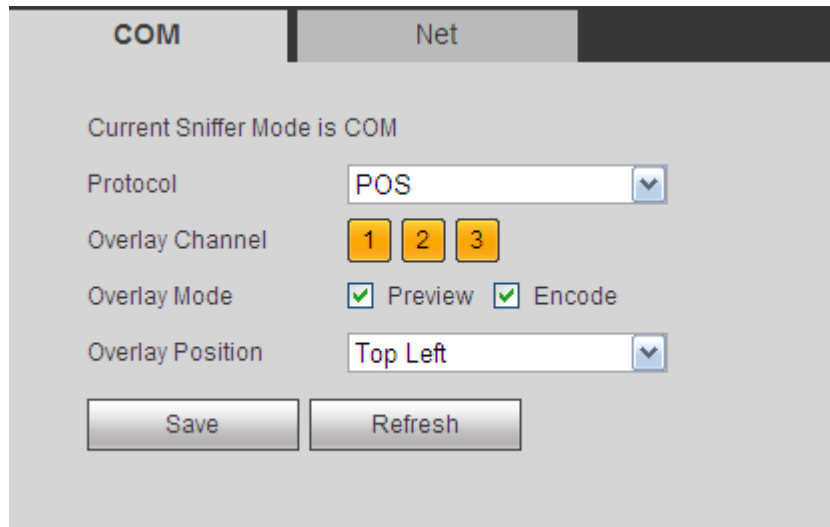

Figure 5-117

5.10.5.7.2 Network Type

The network type interface is shown as below. See Figure 5-118.

Here we take the ATM/POS protocol to continue.

There are two types: with or without the protocol according to client's requirements.

With the protocol

For ATM/POS with the protocol, you just need to set the source IP, destination IP (sometimes you need to input corresponding port number).

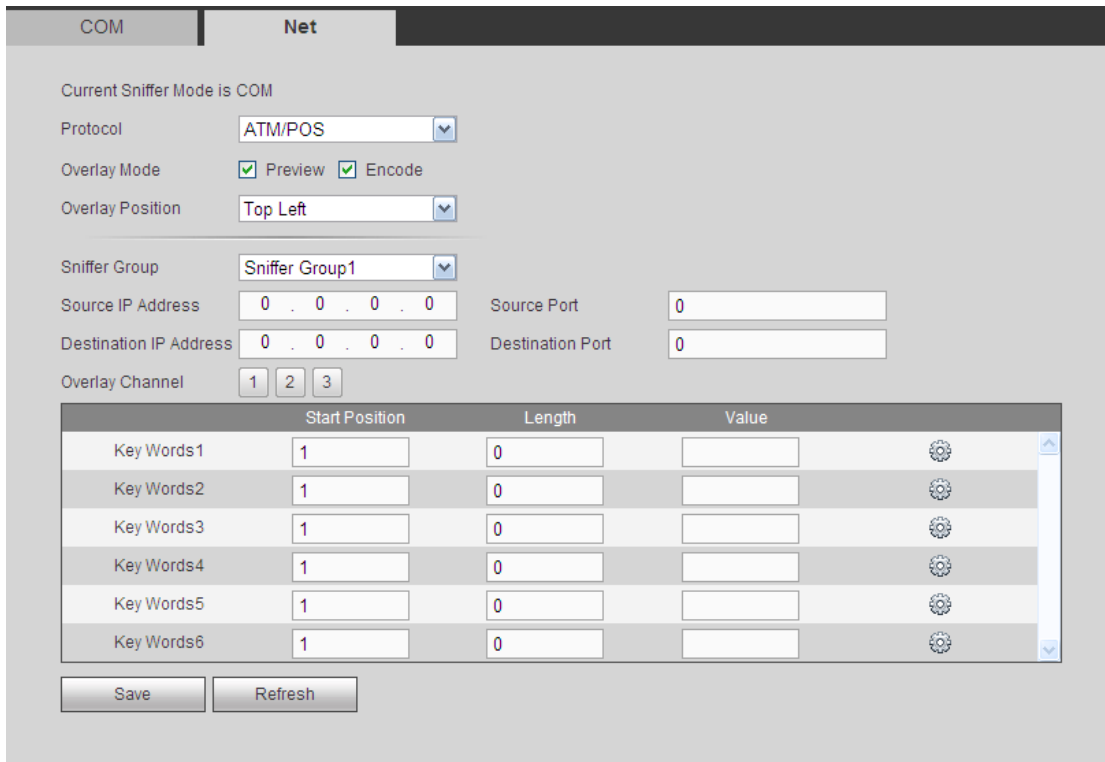

Figure 5-118

Without the protocol

For the ATM/POS without the protocol, the interface is shown as in Figure 5-119.

Source IP refers to host IP address that sends out information (usually it is the device host.)

Destination IP refers to other systems that receive information.

Usually you do not need to set source port and target port.

There are total four groups IP. The record channel applies to one group (optional) only.

Six frame ID groups verification can guarantee information validity and legal.

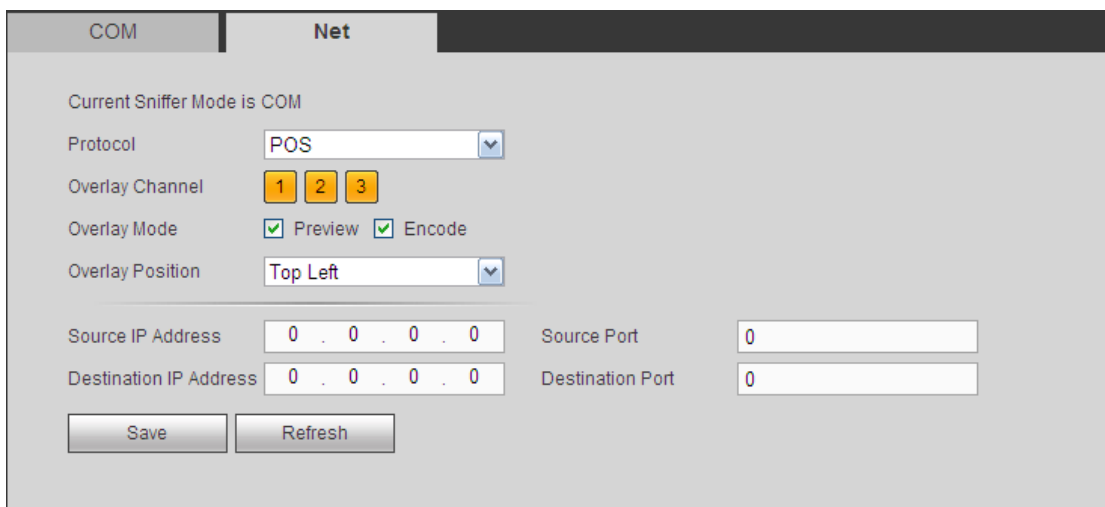

Figure 5-119

5.10.5.8 Voice

The audio function is to manage audio files and set schedule play function. It is to realize audio broadcast activation function.

5.10.5.8.1 File List

Here you can add audio file, or delete audio file. See Figure 5-120.

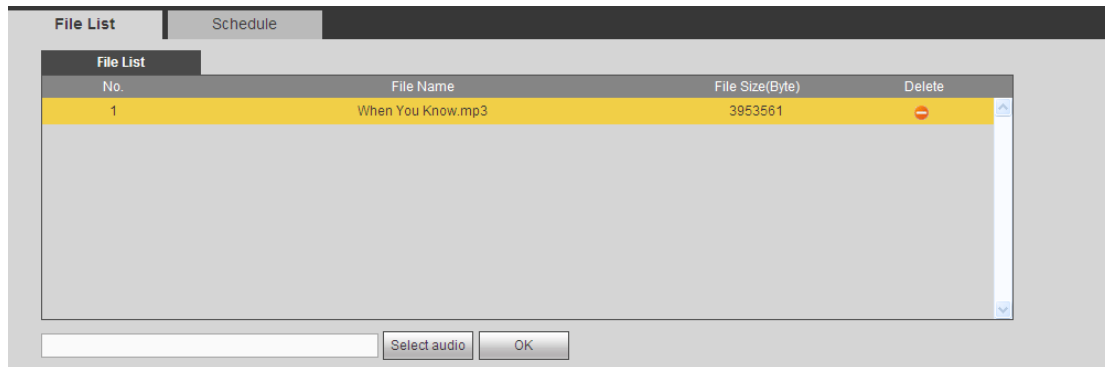

Figure 5-120

Click Add button, you can add audio file and import the audio file via the local computer. See Figure 5-121.

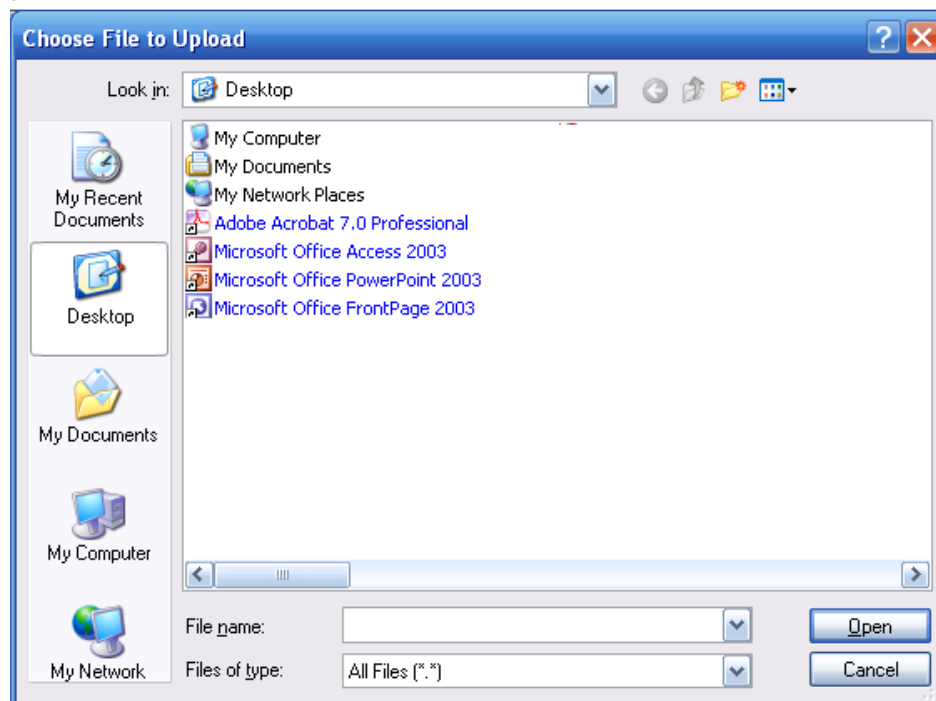

Figure 5-121

5.10.5.8.2 Schedule

It is to set schedule broadcast function. You can play the different audio files in the specified periods.

From main menu->Setup->System->Voice->.Schedule, you can see the following interface. See Figure 5-122.

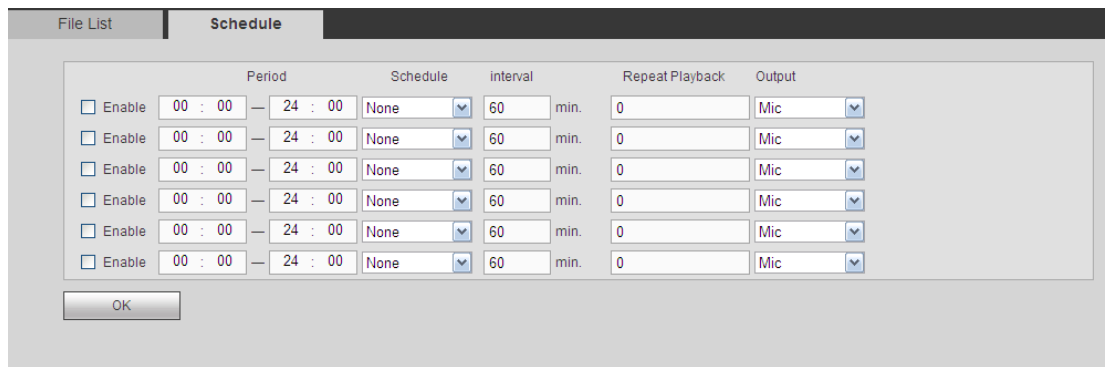

Figure 5-122

Please refer to the following sheet for detailed information.

Parameter	Function
Period	There are six periods. Check the box to enable current setup.
Repeat	It is to set audio file repeat times in the specified period.
Interval	It is the audio file repeated interval in the specified period.
Output port	There are two options: MIC (default)/audio. When reuse the MIC port and bidirectional talk port, the bidirectional port has the higher priority. Please note some series product does not support audio function.

 **Note**

- The audio file end time depends on the audio file size and the interval setup.
- Priority: Bidirectional talk>Event trigger alarm>Trial listening>Audio schedule broadcast.

5.10.5.9 Account

 **Note**

- For the user name, the string max length is 31-byte, and for the user group, the string max length is 15-byte. The user name can only contain English letters, numbers and “_”, “@”, “.”.
- The default user amount is 64 and the default group amount is 20. System account adopts two-level management: group and user. The user authorities shall be smaller than group authorities (The **admin** user authorities are set by default).
- For group or user management, there are two levels: admin and user. The user name shall be unique and one user shall only belong to one group.

5.10.5.9.1 User name

From main menu->Setup->System->Account->Account, enter account interface. See Figure 5-123.

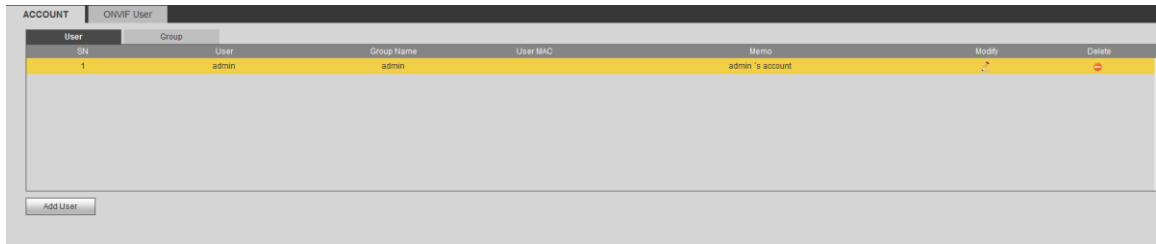

Figure 5-123

Add user

It is to add a name to group and set the user rights.

Step 1 Click Add user button.

Enter add user interface. See Figure 5-124.

Step 2 Here you can input the user name and password and then select one group for current user.

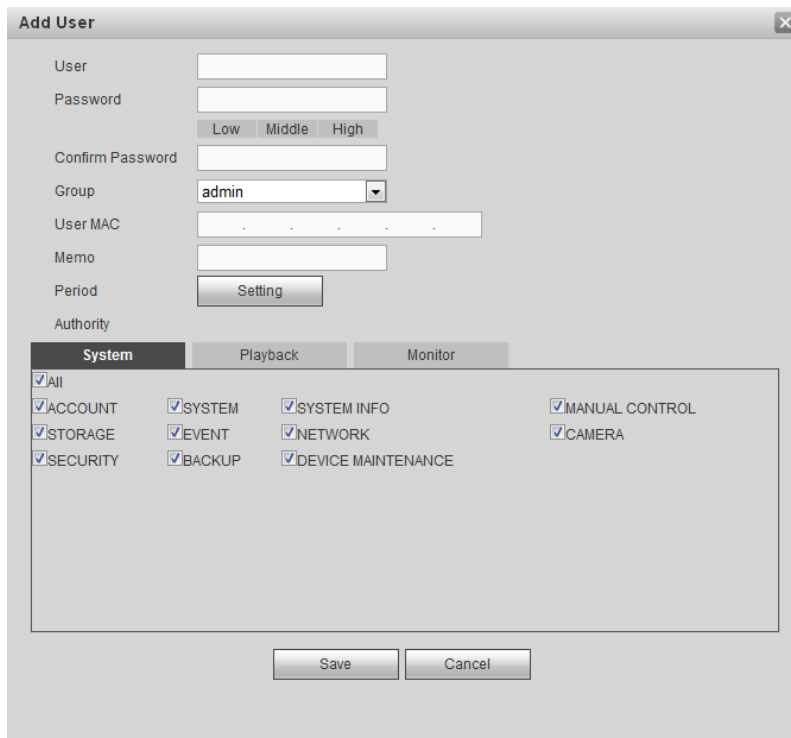

Figure 5-124

Step 3 Click the Set button after the period. It is to set valid period to use current account. See Figure 4-114.

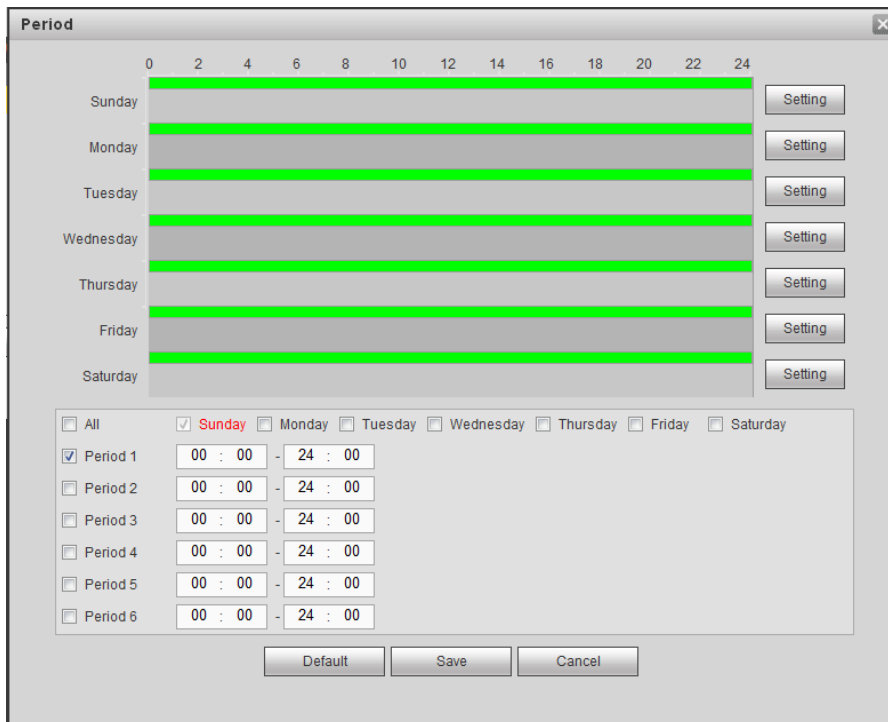

Figure 5-125

- Click Setting to set the periods. Or you can draw on the interface directly. There are six periods in one day. Or you can input start time and end time directly.
- Check the box before the date, the settings are for the selected date(s).
- Check the box before the period1-6, it is to enable the period function.

Step 4 Click Save to complete the setup.



Note

Please note the user rights shall not exceed the group right setup. For convenient setup, please make sure the general user has the lower rights setup than the admin.

Modify user

It is to modify the user property, belonging group, password and rights. See Figure 5-126.

Modify User

User: test

Group: admin

Memo:

User MAC:

Period:

Modify Password

Authority

System	Playback	Monitor
<input checked="" type="checkbox"/> All		
<input checked="" type="checkbox"/> ACCOUNT	<input checked="" type="checkbox"/> SYSTEM	<input checked="" type="checkbox"/> SYSTEM INFO
<input checked="" type="checkbox"/> STORAGE	<input checked="" type="checkbox"/> EVENT	<input checked="" type="checkbox"/> NETWORK
<input checked="" type="checkbox"/> SECURITY	<input checked="" type="checkbox"/> BACKUP	<input checked="" type="checkbox"/> DEVICE MAINTENANCE
		<input checked="" type="checkbox"/> MANUAL CONTROL
		<input checked="" type="checkbox"/> CAMERA

Figure 5-126

 **Note**

For admin, you can change the email information. See Figure 5-127.

The screenshot shows a 'Modify User' window with the following fields and options:

- User: admin
- Group: admin
- Memo: admin 's account
- User MAC:
- Modify Password
- Email Address: z***@tech.com
- Authority:
 - System (selected):
 - All
 - ACCOUNT
 - STORAGE
 - SECURITY
 - Playback:
 - SYSTEM
 - EVENT
 - BACKUP
 - Monitor:
 - SYSTEM INFO
 - NETWORK
 - DEVICE MAINTENANCE
 - Other permissions:
 - MANUAL CONTROL
 - CAMERA

Buttons: Save, Cancel

Figure 5-127

Modify password

It is to modify the user password.

Step 1 In Modify user interface, click Modify password box. See Figure 5-128.

Figure 5-128

Step 2 Input old password, and then input new password and confirm.

Step 3 Click Save button.



Note

The password ranges from 8 to 32 digitals. It can contain letters, numbers and special characters (excluding “” , “” , “;” , “:” , “&”) . The password shall contain at least two categories. Usually we recommend the strong password.



WARNING

STRONG PASSWORD RECOMMENDED-For your device own safety, please create a strong password of your own choosing. We also recommend you change your password periodically especially in the high security system.

5.10.5.9.2 Group

It is to add/remove group, modify group password and etc.

From main menu->Setup->System->Account->Account.

Click Group tab, the interface is shown as in Figure 5-129.

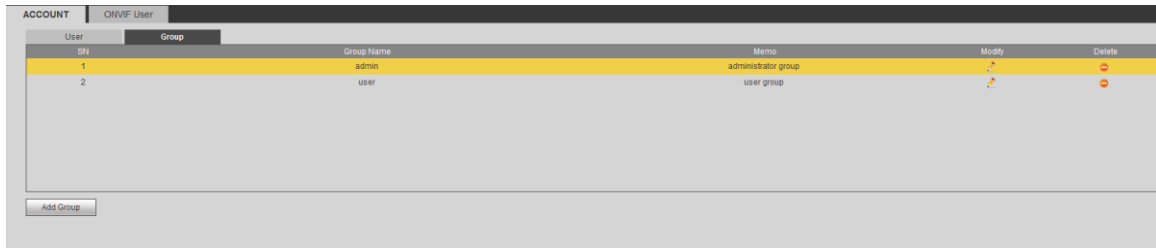

Figure 5-129

Add group

It is to add group and set its corresponding rights.

Step 1 Click Add group button. Enter add group interface. See Figure 5-130.

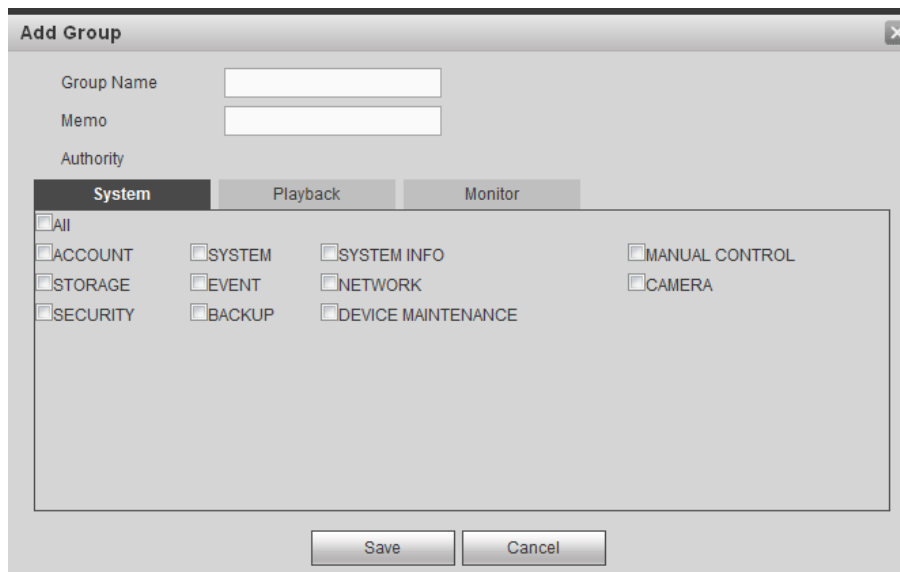



Figure 5-130

Step 2 Input the group name and then check the box to select the corresponding rights. It includes: system, playback, and monitor.

Step 3 Click Save button.

Modify group

Step 1 Select a group and then click . See Figure 5-131.

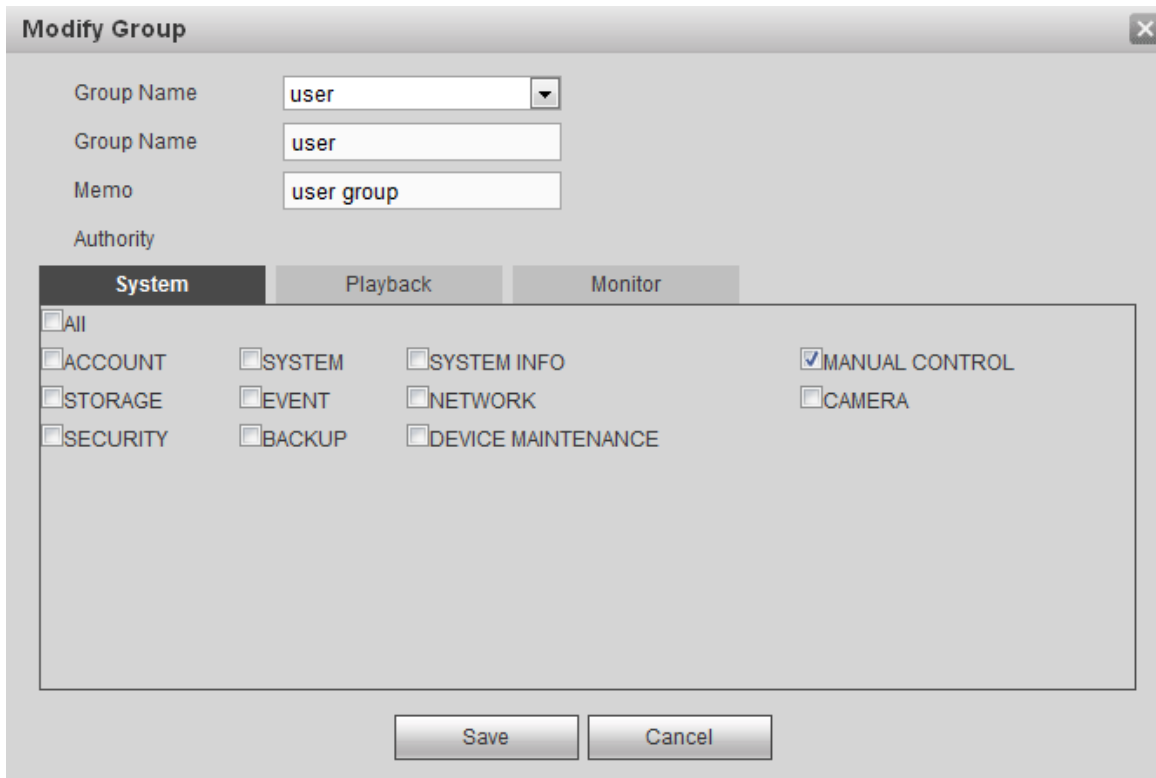

Figure 5-131

Step 2 Change corresponding information and then click Save button.

5.10.5.9.3 ONVIF User

When the camera from the third party is connected with the DVR via the ONVIF user, please use the verified ONVIF account to connect to the DVR.

Step 1 From main menu->Setting->System->Account->ONVIF User.

Enter ONVIF user interface. See Figure 5-132.

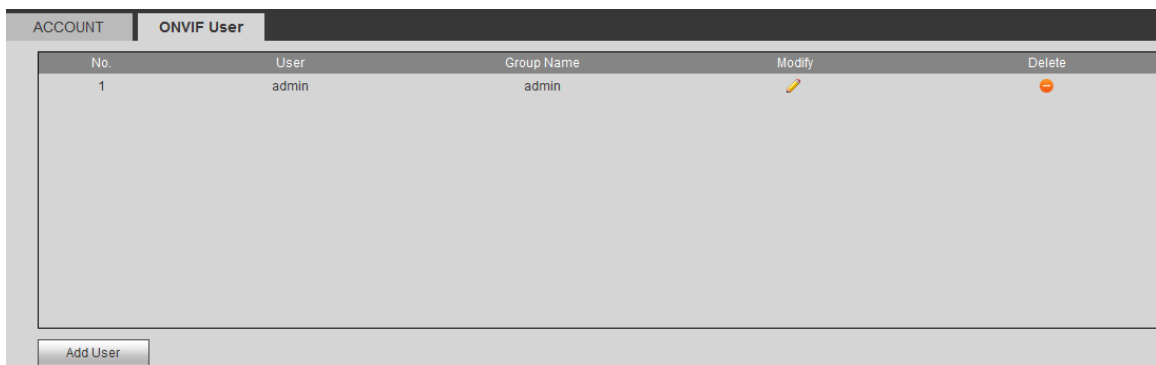

Figure 5-132

Step 2 Click Add user button.

Enter add user interface. See Figure 5-133.

The 'Add User' dialog box includes the following elements:



- User:** A text input field.
- Password:** A text input field.
- Password Strength:** Three radio buttons labeled 'Low', 'Middle', and 'High'. The 'Low' button is selected and highlighted in red.
- Confirm Password:** A text input field.
- Group:** A dropdown menu currently showing 'admin'.
- Buttons:** 'Save' and 'Cancel' buttons at the bottom.

Figure 5-133

Step 3 Set user name, password and then select group from the dropdown list.

Step 4 Click Save to complete setup.

 **Note**

Click  to change user information, click  to delete current user.

5.10.5.10 Auto maintain

The auto maintain interface is shown as in Figure 5-134.

It is to set auto-reboot time during the spare period if the device is running for a long time.

It is to enhance device operation speed.

The 'Auto Maintain' configuration page includes the following elements:

- Auto Reboot:** A dropdown menu set to 'Sunday' and a time input field set to '02 : 00'.
- Auto Delete Old Files:** A dropdown menu set to 'Customized' and a text input field set to '21' followed by 'Days ago'.
- Buttons:** 'Manual Reboot', 'Save', and 'Refresh' buttons.

Figure 5-134

5.10.5.11 Import/Export

The interface is shown as in Figure 5-135.

The 'Import&Export' configuration page includes the following elements:

- Buttons:** 'Config Import' and 'Config Export' buttons.

Figure 5-135

Please refer to the following sheet for detailed information.

Parameter	Function
Import	It is to import the local setup files to the system.
Export	It is to export the corresponding WEB setup to your local PC.

5.10.5.12 Default

Note

This function is for admin user only.

The default setup interface is shown as in Figure 5-136.

Here you can select Channel/Network/Event/Storage/System. Or you can check the All box to select all items.

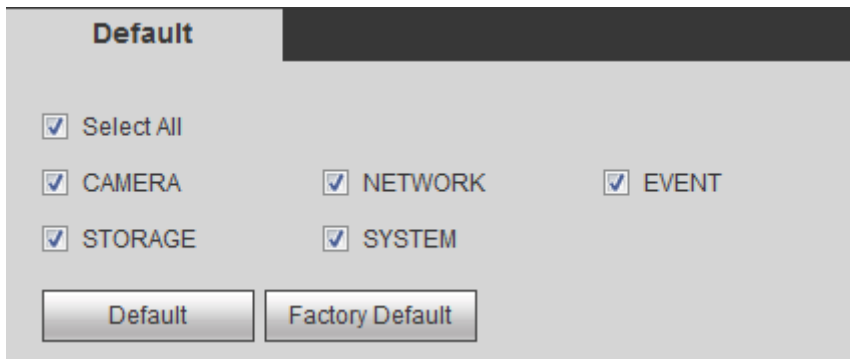

Figure 5-136

5.10.5.13 Upgrade

CAUTION

- During the upgrade process, do not unplug the power cable, network cable, or shutdown the device.
- Improper upgrade program may result in device malfunction!

There are two upgrade modes: file upgrade and online upgrade.

5.10.5.13.1.1 File Upgrade

The upgrade interface is shown as in Figure 5-137.

Please select the upgrade file and then click the update button to begin update. Please note the file name shall be as *.bin.

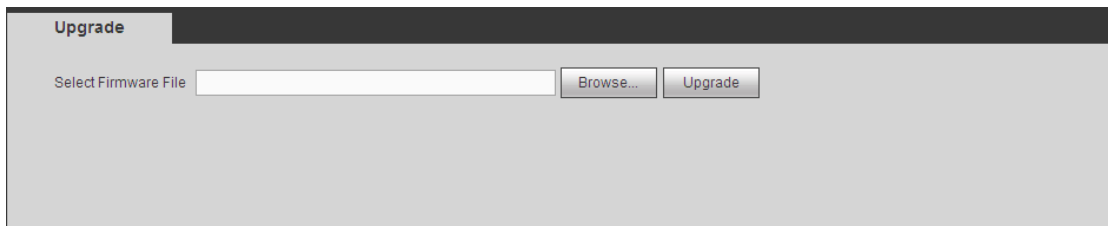

Figure 5-137

5.10.5.13.1.2 Online Upgrade

When the DVR is online, you can use the online upgrade to update the firmware.



Note

Make sure the DVR has properly connected to the network.

Version Detection

The version detection includes auto detection and manual detection. It displays current system version and application released date.

- Enable auto detection, DVR interactive with the cloud to detect there is new version available or not.
- Click manual detection, it is to view the latest new version on the cloud.
- If current version is the latest one, there is prompt “It is the latest version”.
- If DVR detects there is new version available, system displays new version information such as released date and corresponding release note.

Upgrade System

Click Start to upgrade system.

5.10.5.14 Security

5.10.5.14.1 Access Right

To enhance device network security and protect device data, please set the access right of the IP host (IP host here refers to the IP PC or the server). After you enabled trusted sites function, only the IP listed below can access current DVR.

If you enable blocked sites function, the following listed IP addresses cannot access current DVR.

Step 1 From main menu->Setting->System->Security->Access right.

Enter security interface. See Figure 5-138.

Step 2 Check the Enable box.

Select trusted sites/block sites.

- Enable trusted site function and then add the whitelist.
- Enable blocked site function and then add the blacklist.

Step 3 Set parameters.

- Start address/end address: Select one type from the dropdown list, you can input IP address in the start address and end address. Now you can click Add IP address or Add IP section to add. System supports max 64 IP addresses.
 - a) For the newly added IP address, it is in enable status by default. Remove the before the item, and then current item is not in the list.
 - b) System max supports 64 items.
 - c) Address column supports IPv4 or IPv6 format. If it is IPv6 address, system can optimize it. For example, system can optimize aa:0000: 00: 00aa: 00aa: 00aa: 00aa: 00aa as aa:: aa: aa: aa: aa: aa: aa.
 - d) System automatically removes space if there is any space before or after the

- newly added IP address.
- e) System only checks start address if you add IP address. System check start address and end address if you add IP section and the end address shall be larger than the start address.
 - f) System may check newly added IP address exists or not. System does not add if input IP address does not exist.
- Delete: Click it to remove specified item.
 - Edit: Click it to edit start address and end address. See Figure 5-139. System can check the IP address validity after the edit operation and implement IPv6 optimization.
 - Default: Click it to restore default setup. In this case, the trusted sites and blocked sites are both null.
- Step 4 Click Save to complete setup.
- If you enabled trusted sites, only the IP in the trusted sites list can access the device.
 - If you enabled blocked sites, the IP in the blocked sites cannot access the device.



Figure 5-138

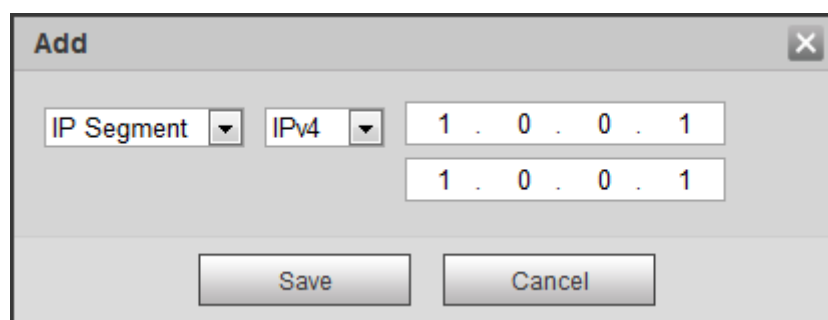

Figure 5-139





5.10.5.14.2 System Service

It is to enable/disable system service.

Step 1 From main menu->Setting->System->Security->System Service.

Enter system service interface. See Figure 5-140.

Step 2 Set parameters.

Parameter	Function
Password reset	It is to enable/disable password reset function. You can only go to the local menu to answer the security questions to reset password if this function is disabled.  Note This function is enabled by default.
Mobile phone push	The alarm triggered snapshot image can push to the mobile phone if this function is enabled.  Note This function is enabled by default.
CGI	Front-end device can use CGI protocol to connect to the device.  Note This function is enabled by default.
ONVIF	Front-end device can use ONVIF protocol to connect to the device.  Note This function is enabled by default.
Audio/video transmission encryption	The audio/video transmission is encrypted if this function is enabled. Make sure the corresponding device or software supports video decryption function.

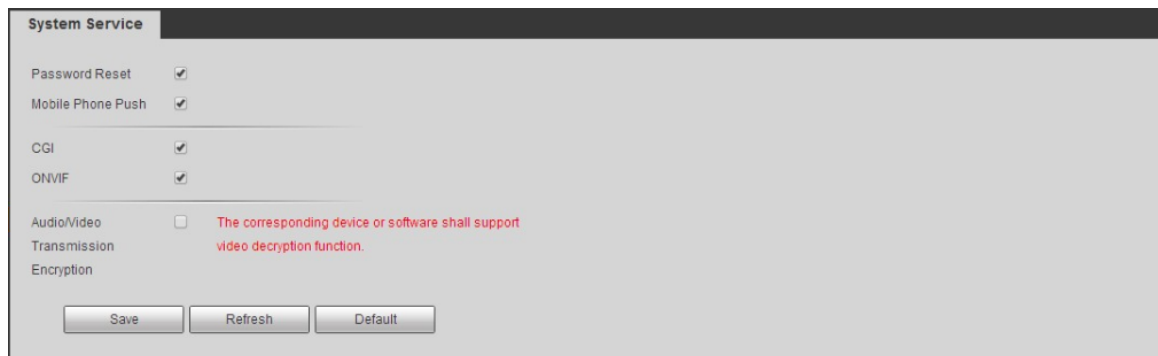

Figure 5-140

Step 3 Click Save or Apply.

5.10.5.14.3 HTTPS

From main menu->Setting->System->Security->HTTPS, enter HTTPS interface. See Figure 5-141.

In this interface, you can set to make sure the PC can successfully login via the HTTPS. It is to guarantee communication data security. The reliable and stable technology can secure the user information security and device safety..

 **Note**

- You need to implement server certificate again if you have changed device IP.
- You need to download root certificate if it is your first time to use HTTPS on current PC.

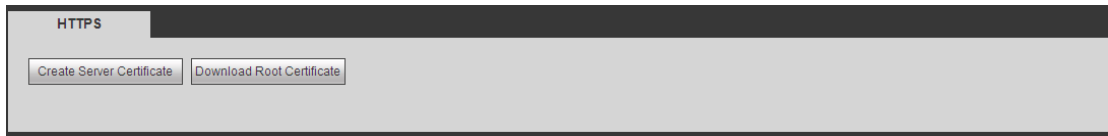
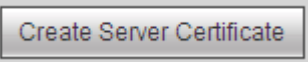

Figure 5-141

5.10.5.14.3.1 Create Server Certificate

If it is your first time to use this function, please follow the steps listed below.

In Figure 5-141, click  button, input country name, state name and etc. Click Create button. See Figure 5-142.

Note

Please make sure the IP or domain information is the same as your device IP or domain name.

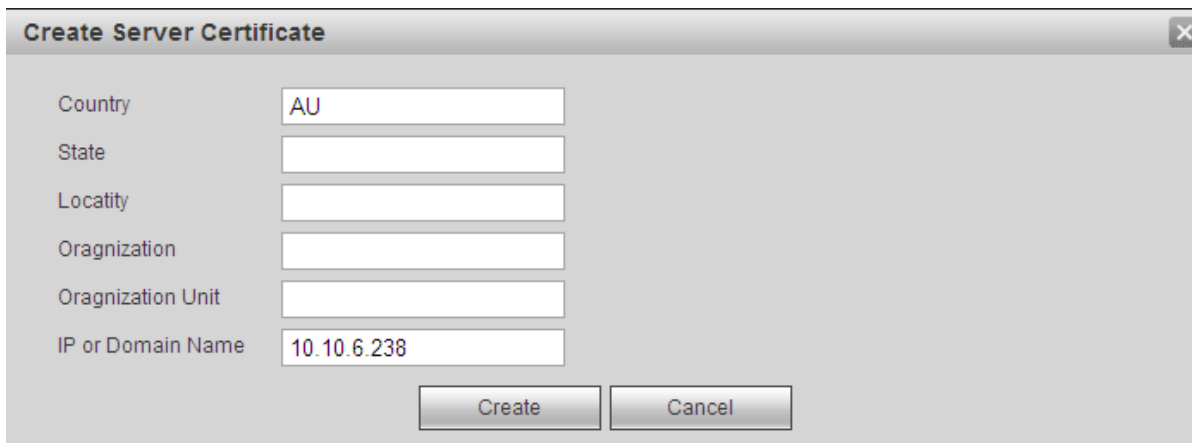

Figure 5-142

You can see the corresponding prompt. See Figure 5-143. Now the server certificate is successfully created.



Figure 5-143

5.10.5.14.3.2 Download root certificate

In Figure 5-141, click  button, system pops up a dialogue box. See Figure 5-144.



Figure 5-144

Click Open button, you can go to the following interface. See Figure 5-145.

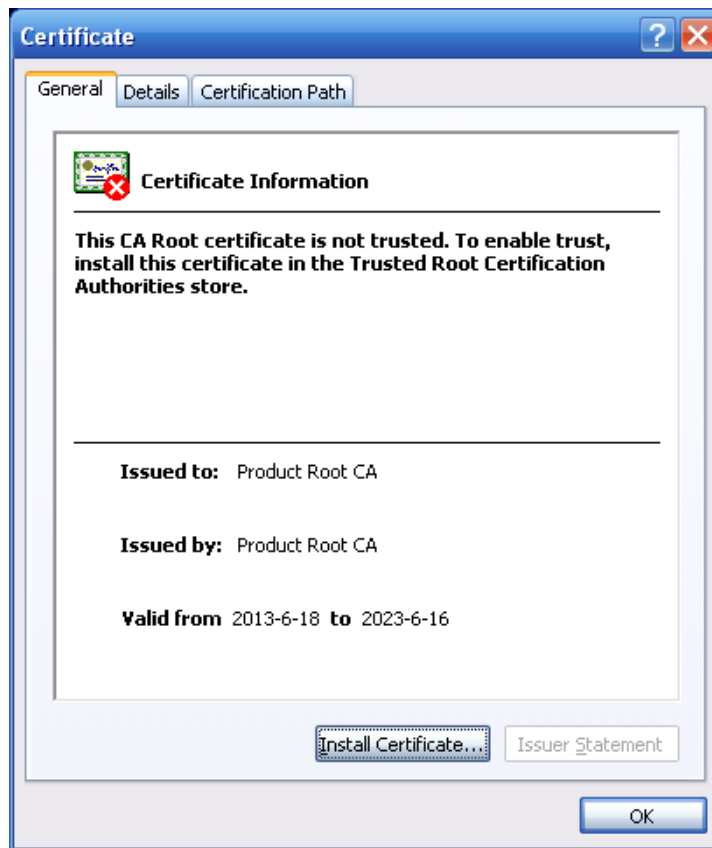

Figure 5-145

Click Install certificate button, you can go to certificate wizard. See Figure 5-146.



Figure 5-146

Click Next button to continue. Now you can select a location for the certificate. See Figure 5-147.

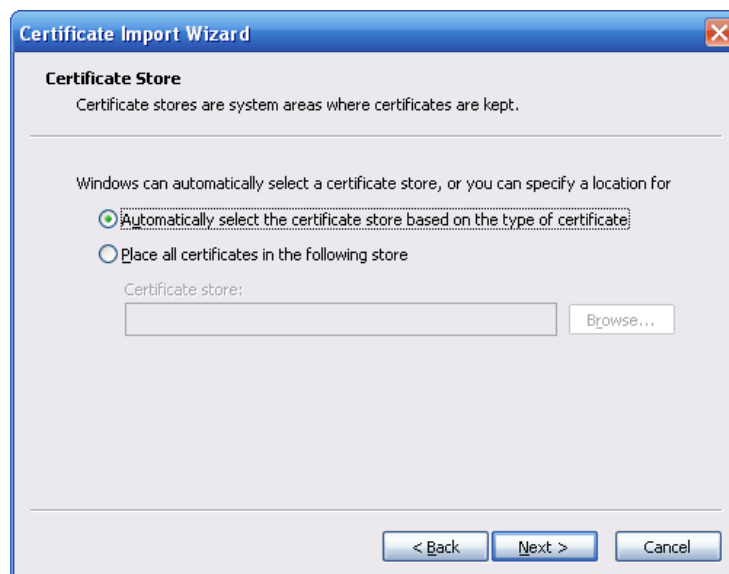

Figure 5-147

Click Next button, you can see the certificate import process is complete. See Figure 5-148.

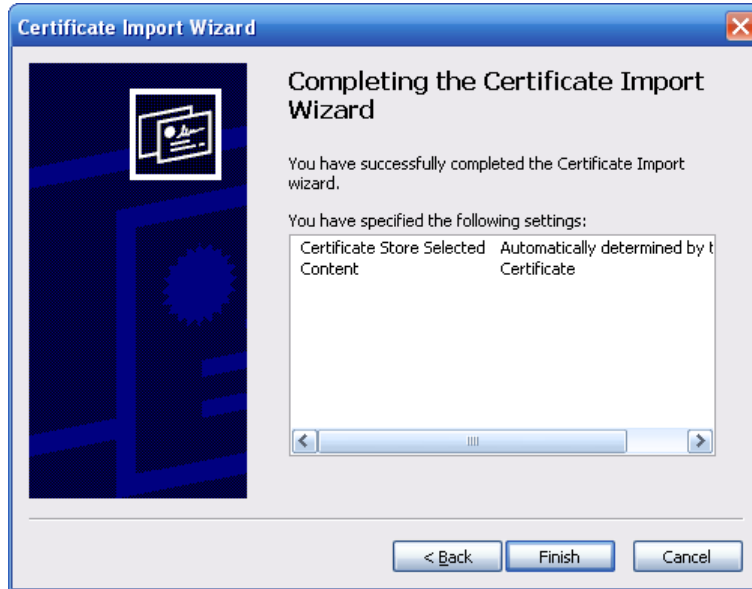

Figure 5-148

Click Finish button, you can see system pops up a security warning dialogue box. See Figure 5-149.

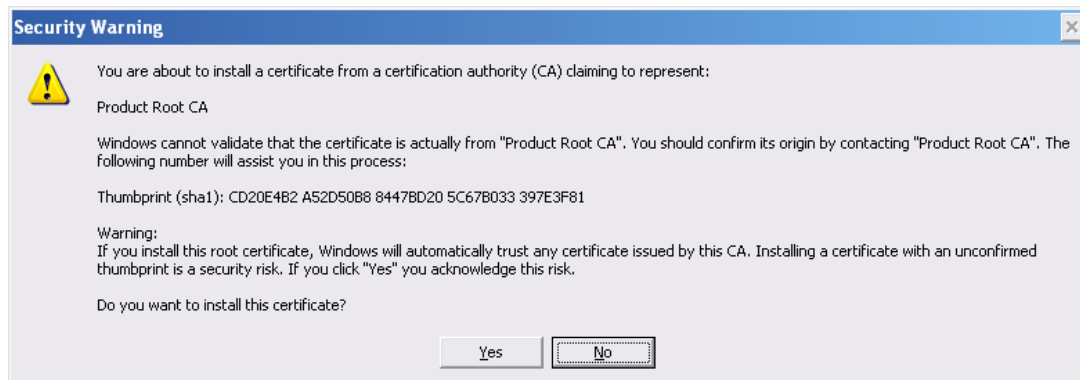

Figure 5-149

Click Yes button, system pops up the following dialogue box, you can see the certificate download is complete. See Figure 5-150.



Figure 5-150

5.10.5.14.3.3 View and set HTTPS port

From Setup->Network->Connection, you can see the following interface. See Figure

5-151.

You can see HTTPS default value is 443.

The screenshot shows a 'Connection' configuration window with the following fields and values:

Max Connection	128	(0~128)
TCP Port	37777	(200~65535)
UDP Port	37778	(200~65535)
HTTP Port	80	(1~65535)
HTTPS Port	443	(128~65535)
RTSP Port	554	(128~65535)
RTSP Format	rtsp://<User Name>:<Password>@<IP Address>:<Port>/cam/realmonitor?channel=1&subtype=0 channel: Channel, 1-32; subtype: Code-Stream Type, Main Stream 0, Sub Stream 1.	

Buttons: Save, Refresh, Default

Figure 5-151

5.10.5.14.3.4 Login

Open the browser and then input <https://xx.xx.xx.xx:port>.

xx.xx.xx.xx: is your device IP or domain name.

Port is your HTTPS port. If you are using default HTTPS value 443, you do not need to add port information here. You can input <https://xx.xx.xx.xx> to access.

Now you can see the login interface if your setup is right.

5.11 Information

5.11.1 Version

Here you can view record channel, alarm input/output information, software version, release date and etc.

5.11.2 Log

Here you can view system log. See Figure 5-152.

The screenshot shows a 'Log' interface with the following details:

Start Time: 2014 - 08 - 21 00 : 00 : 00 End Time: 2014 - 08 - 22 00 : 00 : 00

Type: All Search Matched 63 logs Log Time 2014-08-21 11:38:36 - 2014-08-21 16:35:38

No.	Time	Event
1	2014-08-21 11:38:36	Shut down
2	2014-08-21 11:38:36	Boot up
3	2014-08-21 11:38:36	Video Loss
4	2014-08-21 11:38:36	Video Loss
5	2014-08-21 11:38:36	Video Loss
6	2014-08-21 11:38:36	Video Loss
7	2014-08-21 11:38:36	HDD
8	2014-08-21 11:38:56	User logged in

System Log Info

Buttons: Backup, Clear Page: 1 / 1 Go To: 1

Figure 5-152

Please refer to the following sheet for log parameter information.

Parameter	Function
Type	Log types include: system operation, configuration operation, data operation, event operation, record operation, user management, log clear.
Start time	Set the start time of the requested log.
End time	Set the end time of the requested log.
Search	You can select log type from the drop down list and then click search button to view the list. You can click the stop button to terminate current search operation.
Detailed information	You can select one item to view the detailed information.
Clear	You can click this button to delete all displayed log files. Please note system does not support clear by type.
Backup	You can click this button to backup log files to current PC.

5.11.3 Online User

It is to display current online user, user group, IP address and login time.

The online user interface is shown as in Figure 5-153.

No.	User Name	Group Name	IP Address	User Login Time
1	admin	admin	10.15.9.152	2013-10-24 04:31:33 PM
2	admin	admin	10.15.9.152	2013-10-24 04:21:12 PM
3	admin	admin	10.15.6.145	2013-10-24 04:50:01 PM

Refresh

Figure 5-153

5.11.4 HDD

The HDD interface is shown as in Figure 5-154. Here you can view HDD information.

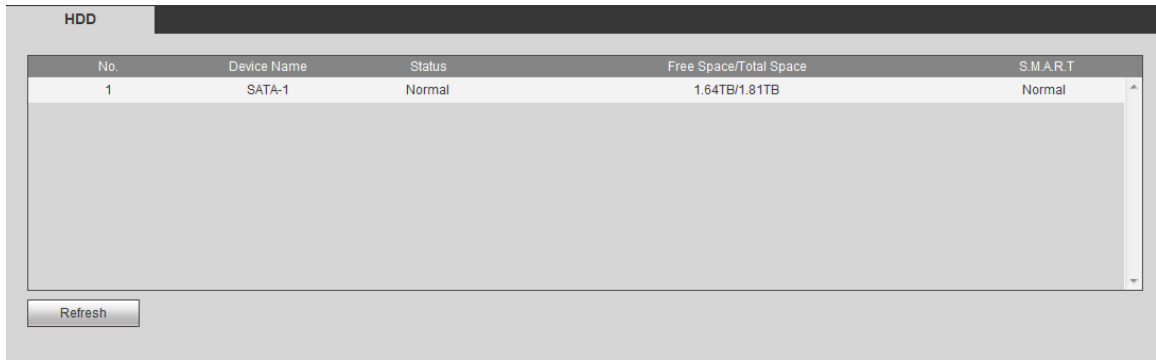

Figure 5-154

5.12 Playback

Click Playback button, you can see an interface is shown as in Figure 5-155.

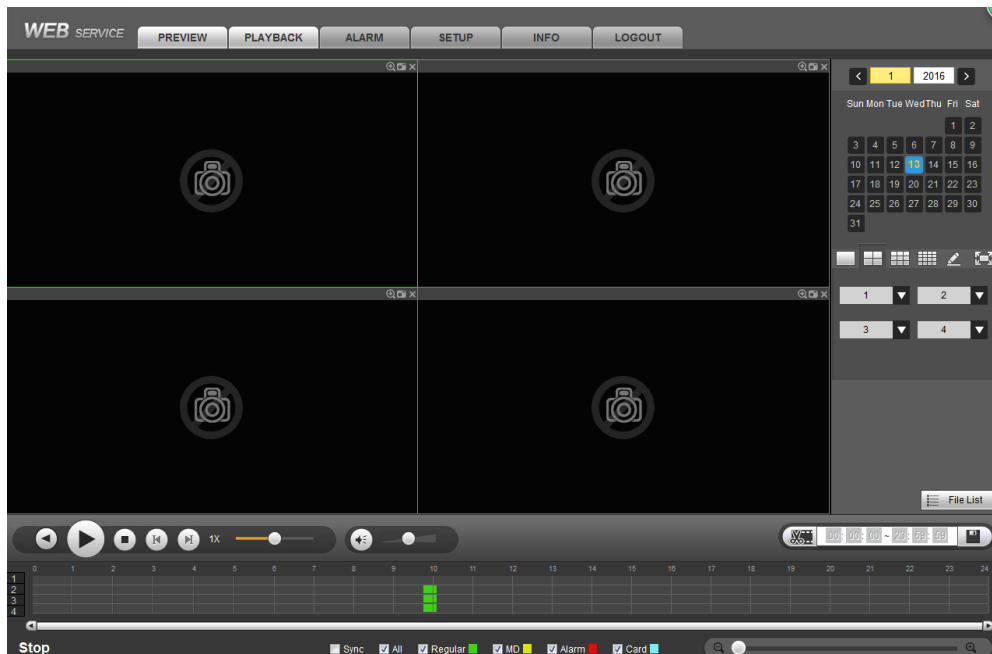

Figure 5-155

5.12.1 Search Record

Please set record type, record date, window display mode and channel name.

- Select Date

You can click the date on the right pane to select the date. The green highlighted date is system current date and the blue highlighted date means it has record files.

- Window Split

Select window split mode. Click  to display in full screen. Click ESC button to exit.

See Figure 5-156.



Figure 5-156

- Customized playback

Click , you can see the following interface. See Figure 5-157.

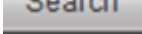

Figure 5-157

Now you can select one or more channel(s) and then click  to search record(s).

System supports one or more channels. The window split mode can auto adjust according to the channel amount. System max supports 16-split.

Click  button to select all channels at the same time.

Click , system begins playback.

- Select Channel

1~n(n depends on your product channel amount) means main stream and A1~An ((n depends on your product channel amount)) means sub stream.

- Select Record Type

Check the corresponding box to select record type. See Figure 5-158.



Figure 5-158

5.12.2 Fisheye Playback De-Warp

 **Note**

Some series product supports de-warp function.

When playing fisheye channel record file, it can de-warp.

In 1-window playback mode, click the  at the top right corner, system pops up installation mode and display mode interface. Select the corresponding mode, it can display the dewarp video. Please refer to Fisheye de-warp in chapter 5.6.1 for detailed information.

5.12.3 File List

Click File list button, you can see the corresponding file(s) in the list. See Figure 5-159.

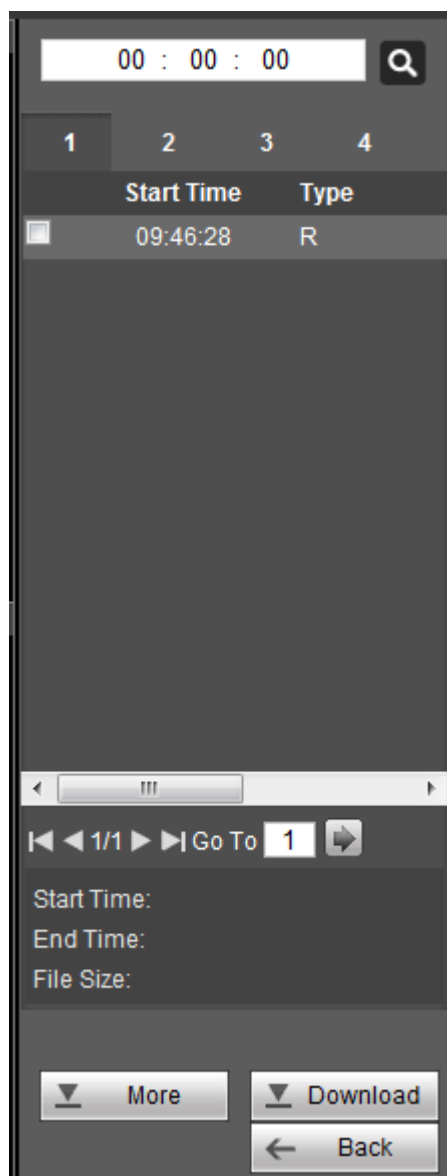

Figure 5-159

5.12.4 Playback

Select a file you want to play and then click Play button, system can begin playback. You can select to playback in full-screen. Please note for one channel, system cannot

playback and download at the same time. You can use the playback control bar to implement various operations such as play, pause, stop, slow play, fast play and etc.

5.12.5 Download

Select the file(s) you want to download and then click download button, you can see an interface shown as in Figure 5-160. The Download button becomes Stop button and there is a process bar for your reference. Please go to you default file saved path to view the files.

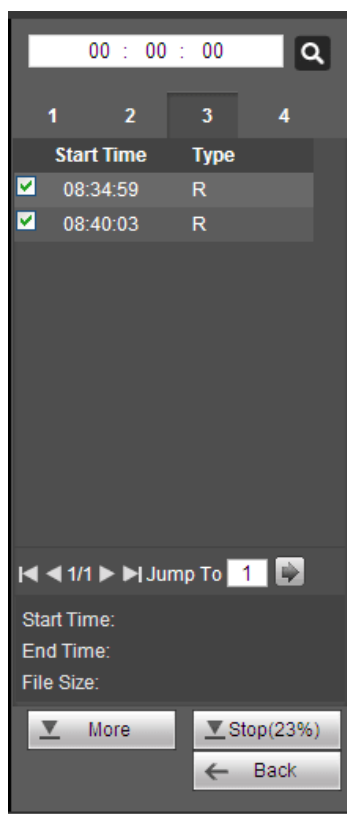

Figure 5-160

5.12.6 Load more

It is for you to search record or picture. You can select record channel, record type and record time to download. Or you can use watermark function to verify file.

5.12.6.1 Download By File

Select channel, record type, bit stream type and then input start time and end time. Click Search button, the download by file interface is shown as in Figure 5-161.

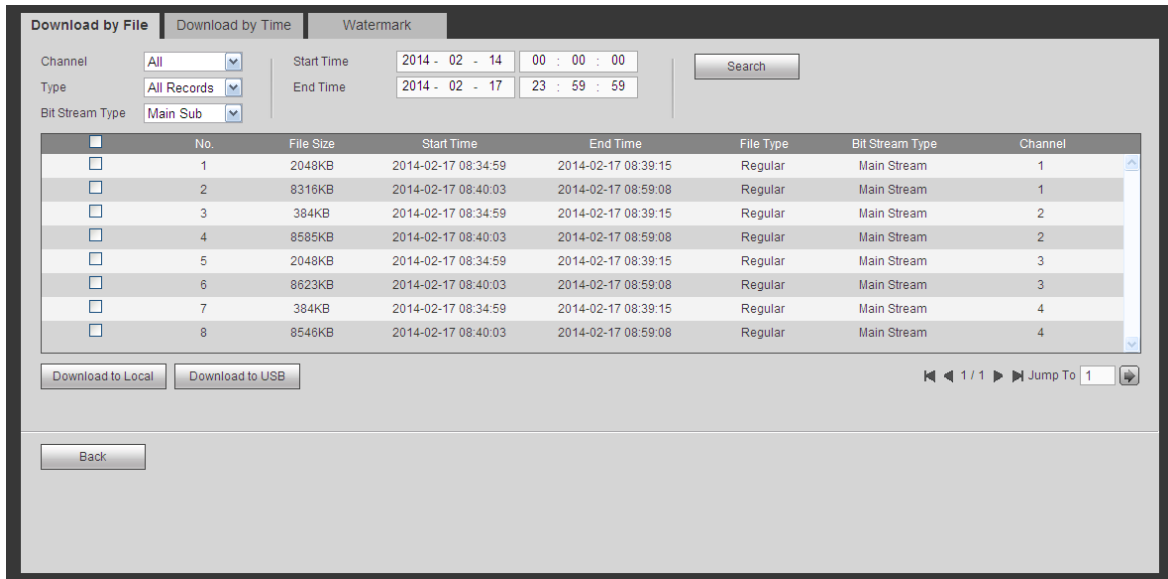

Figure 5-161

Check the file(s) you want to download and there are two options for you to save the file(s).

- Download to local

Click Download to local, system pops up the following interface for you to set record format and saved path. See Figure 5-162.

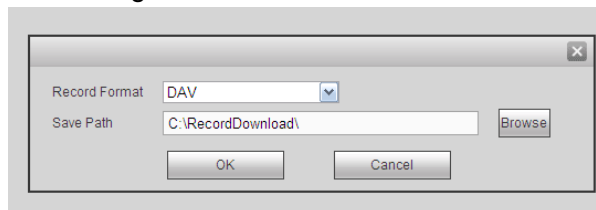

Figure 5-162

You can click OK to download and view the download process. After the download operation, you can see corresponding dialog box.

- Download to USB

Connect the corresponding peripheral device, and then click Download to USB button, you can see the following interface. See Figure 5-163.

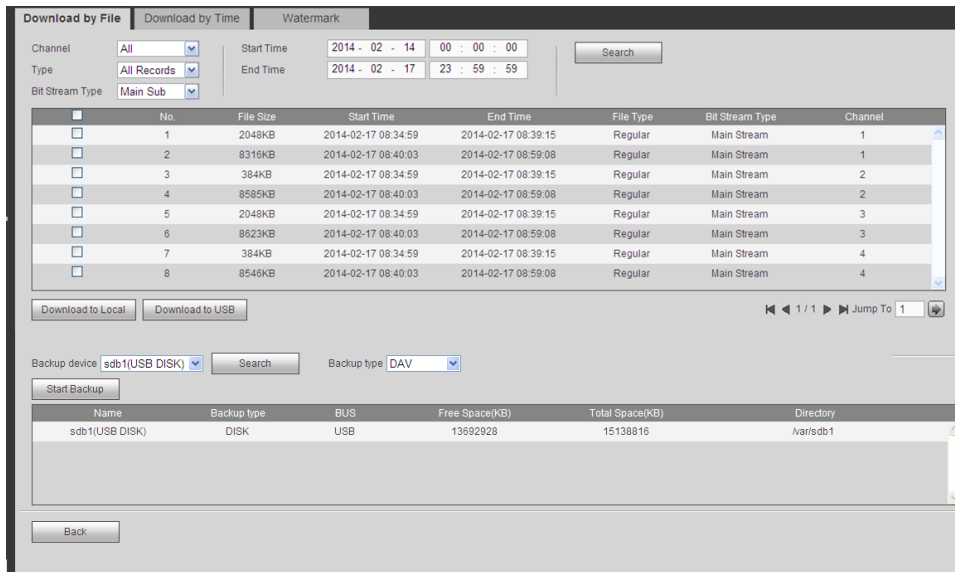

Figure 5-163

Select Backup device and backup type first and then click Start backup button. After the download operation, you can see corresponding dialogue box.

5.12.6.2 Download by Time

Select channel, bit stream type, start time and end time.

Click Download to Local button, you can see download by time interface is shown as in Figure 5-164.

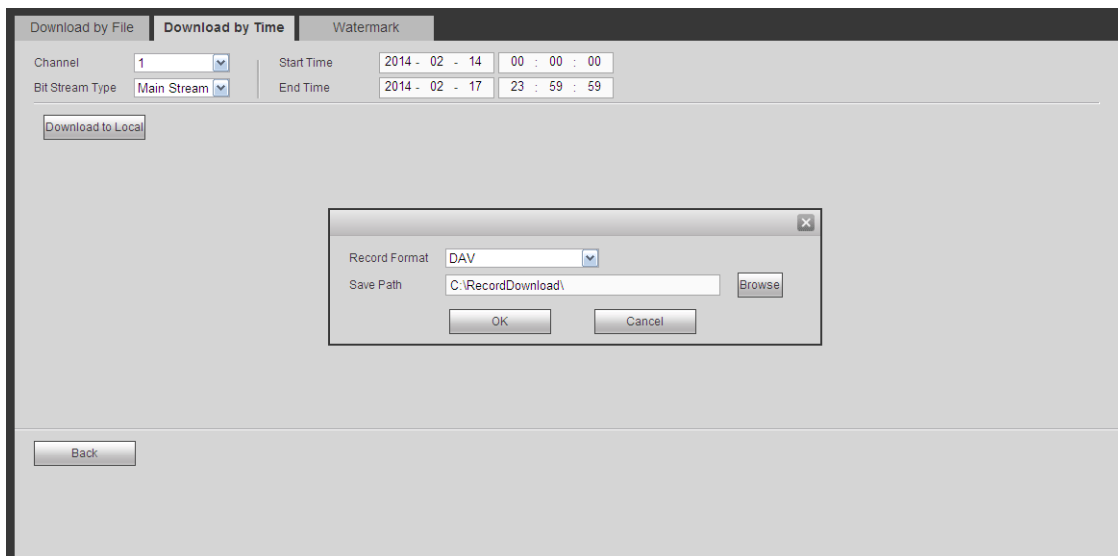

Figure 5-164

Set record format and saved path, you can click OK to download and view the download process. After the download operation, you can see corresponding dialog box.

5.12.6.3 Watermark

Watermark interface is shown as In Figure 5-165. Please select a file and then click Verify button to see the file has been tampered with or not

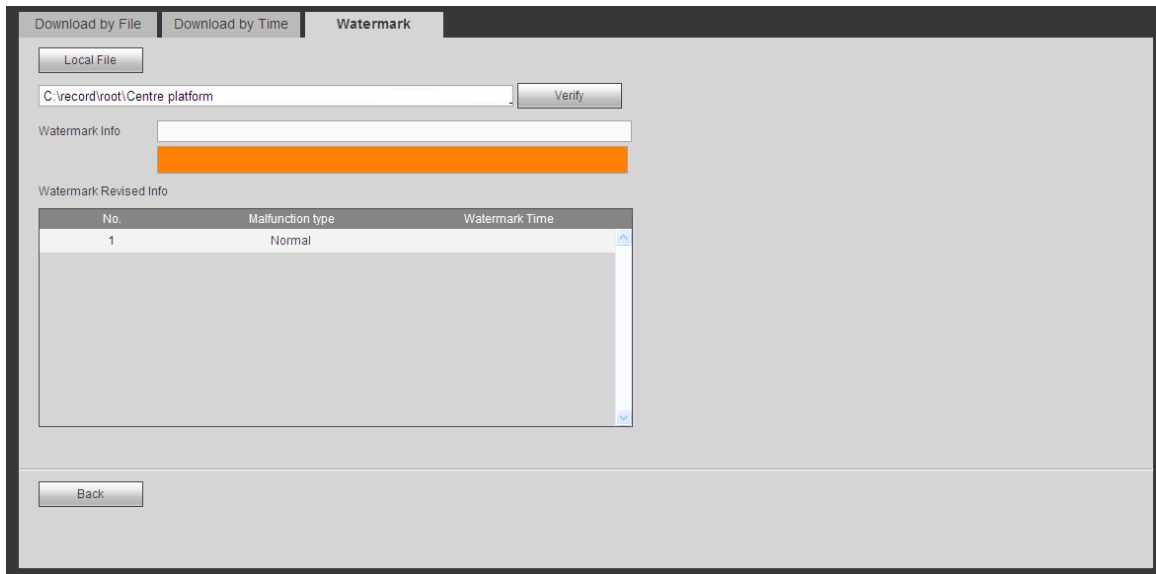

Figure 5-165

5.13 Face Search

On the main interface, click Face search button, you can see an interface shown as below. See Figure 5-166.

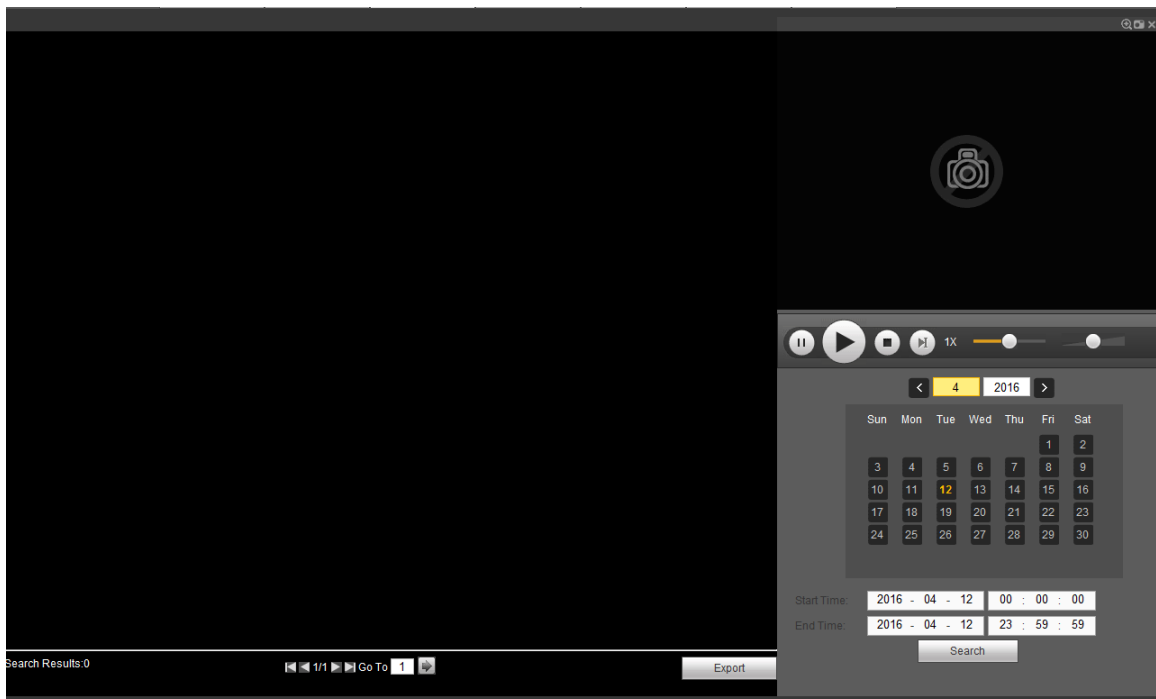

Figure 5-166

Please refer to the following sheet for detailed information.

SN	Name	Function
----	------	----------

SN	Name	Function
1	Display pan	<ul style="list-style-type: none"> ● It is to display human face detection file list. The latest file is at the top. \ ● Click Export, you can export the selected file to the USB device. There are two types: image/record. <ul style="list-style-type: none"> ✧ Image: Export the recognized human face image. ✧ Record: Export the record file before and after 10 seconds when the DVR recognizes the human face.
2	Playback pane	Play the searched record file or image. Double click to playback in full screen.
3	Search pane	Set date, start time and end time, click Search button, you can view the corresponding file list.

5.14 Alarm

Click alarm function, you can see an interface is shown as Figure 5-167.

Here you can set device alarm type and alarm sound setup (Please make sure you have enabled audio function of corresponding alarm events.).

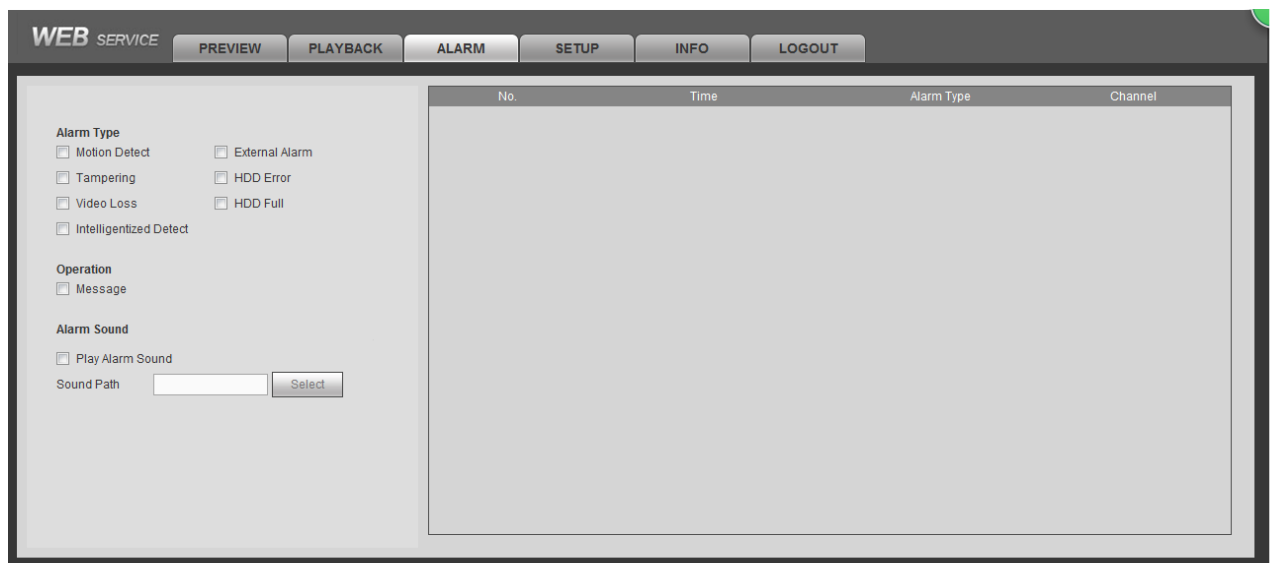

Figure 5-167

Please refer to the following sheet for detailed information.

Type	Parameter	Function
Alarm Type	Video loss	System alarms when video loss occurs.
	Motion detection	System alarms when motion detection alarm occurs.
	Tampering	System alarms when camera is viciously masking.
	Disk full	System alarms when disk is full.
	Disk error	System alarms when disk error occurs.
	External alarm	Alarm input device sends out alarm.

Type	Parameter	Function
Operation	Prompt	Check the box here, system can automatically pops up an alarm icon on the Alarm button in the main interface when there is an alarm.
Alarm Sound	Play alarm sound	System sends out alarm sound when an alarm occurs. You can specify as you wish.
	Sound path	Here you can specify alarm sound file.

5.15 Log out

Click log out button, system goes back to log in interface. See Figure 5-168. Input user name and password to login again.

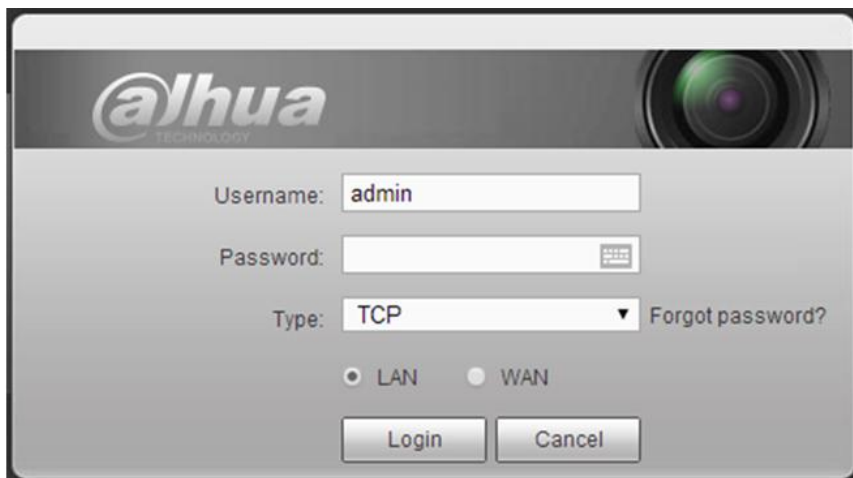

Figure 5-168

5.16 Un-install Web Control

You can use web un-install tool “uninstall web.bat” to un-install web control.

Please note, before you un-installation, please close all web pages, otherwise the un-installation might result in error.

6 SmartPSS

Besides Web, you can use our Smart PSS to login the device.

For detailed information, please refer to *Smart PSS user's manual*.

7 FAQ



1. DVR cannot boot up properly.

There are following possibilities:

- Input power is not correct.
- Power connection is not correct.
- Power switch button is damaged.
- Program upgrade is wrong.
- HDD malfunction or something wrong with HDD ribbon.
- Seagate DB35.1,DB35.2,SV35 or Maxtor 17-g has compatibility problem. Please upgrade to the latest version to solve this problem.
- Front panel error.
- Main board is damaged.

2. How to restore factory default setup even I cannot login the user interface.

There are following possibilities:

- Please use the reset button to restore factory default setup. Please shut down the device, remove the top cover and front panel. Go to the mainboard and find the  button. Press  to boot up and then remain pressing for 5 to 10 seconds. Device automatically restoring factory default setup and then reboot.

Note

Please make sure you purchased device has the reset button on the mainboard.

3. DVR often automatically shuts down or stops running.

There are following possibilities:

- Input voltage is not stable or it is too low.
- HDD malfunction or something wrong with the ribbon.
- Button power is not enough.
- Front video signal is not stable.
- Working environment is too harsh, too much dust.
- Hardware malfunction.

4. System cannot detect hard disk.

There are following possibilities:

- HDD is broken.
- HDD ribbon is damaged.
- HDD cable connection is loose.
- Main board SATA port is broken.

5. There is no video output whether it is one-channel, multiple-channel or all-channel output.

There are following possibilities:

- Program is not compatible. Please upgrade to the latest version.
- Brightness is 0. Please restore factory default setup.
- There is no video input signal or it is too weak.
- Check privacy mask setup or your screen saver.
- DVR hardware malfunctions.

6. Real-time video color is distorted.

There are following possibilities:

- When using BNC output, NTSC and PAL setup is not correct. The real-time video becomes black and white.
- DVR and monitor resistance is not compatible.
- Video transmission is too long or degrading is too huge.
- DVR color or brightness setup is not correct.

7. Cannot search local records.

There are following possibilities:

- HDD ribbon is damaged.
- HDD is broken.
- Upgraded program is not compatible.
- The recorded file has been overwritten.
- Record function has been disabled.

8. Video is distorted when searching local records.

There are following possibilities:

- Video quality setup is too low.
- Program read error, bit data is too small. There is mosaic in the full screen. Please restart the DVR to solve this problem.
- HDD data ribbon error.
- HDD malfunction.
- DVR hardware malfunctions.

9. There is no audio when monitor.

There are following possibilities:

- It is not a power picker.
- It is not a power acoustics.
- Audio cable is damaged.
- DVR hardware malfunctions.

10. There is audio when monitor but there is no audio when system playback.

There are following possibilities:

- Setup is not correct. Please enable audio function
- Corresponding channel has no video input. Playback is not continuous when the screen is blue.

11. Time display is not correct.

There are following possibilities:

- Setup is not correct
- Battery contact is not correct or voltage is too low.
- Crystal is broken.

12. DVR cannot control PTZ.

There are following possibilities:

- Front panel PTZ error
- PTZ decoder setup, connection or installation is not correct.
- Cable connection is not correct.
- PTZ setup is not correct.
- PTZ decoder and DVR protocol is not compatible.
- PTZ decoder and DVR address is not compatible.
- When there are several decoders, please add 120 Ohm between the PTZ decoder A/B cables furthest end to delete the reverberation or impedance matching. Otherwise the PTZ control is not stable.
- The distance is too far.

13. Motion detection function does not work.

There are following possibilities:

- Period setup is not correct.
- Motion detection zone setup is not correct.
- Sensitivity is too low.
- For some versions, there is hardware limit.

14. Cannot log in client-end or web.

There are following possibilities:

- For Windows 98 or Windows ME user, please update your system to Windows 2000 sp4. Or you can install client-end software of lower version. Please note right now, our DVR is not compatible with Windows VISTA control.
- ActiveX control has been disabled.
- No dx8.1 or higher. Please upgrade display card driver.
- Network connection error.
- Network setup error.
- Password or user name is invalid.
- Client-end is not compatible with DVR program.

15. There is only mosaic no video when preview or playback video file remotely.

There are following possibilities:

- Network fluency is not good.
- Client-end resources are limit.

- There is multiple-cast group setup in DVR. This mode can result in mosaic. Usually we do not recommend this mode.
- There is privacy mask or channel protection setup.
- Current user has no right to monitor.
- DVR local video output quality is not good.

16. Network connection is not stable.

There are following possibilities:

- Network is not stable.
- IP address conflict.
- MAC address conflict.
- PC or DVR network card is not good.

17. Burn error /USB back error.

There are following possibilities:

- Burner and DVR are in the same data cable.
- System uses too much CPU resources. Please stop record first and then begin backup.
- Data amount exceeds backup device capacity. It may result in burner error.
- Backup device is not compatible.
- Backup device is damaged.

18. Keyboard cannot control DVR.

There are following possibilities:

- DVR serial port setup is not correct
- Address is not correct
- When there are several switchers, power supply is not enough.
- Transmission distance is too far.

19. Alarm signal cannot be disarmed.

There are following possibilities:

- Alarm setup is not correct.
- Alarm output has been open manually.
- Input device error or connection is not correct.
- Some program versions may have this problem. Please upgrade your system.

20. Alarm function is null.

There are following possibilities:

- Alarm setup is not correct.
- Alarm cable connection is not correct.
- Alarm input signal is not correct.
- There are two loops connect to one alarm device.

21. Remote control does not work.

There are following possibilities:

- Remote control address is not correct.
- Distance is too far or control angle is too small.
- Remote control battery power is low.
- Remote control is damaged or DVR front panel is damaged.

22. Record storage period is not enough.

There are following possibilities:

- Camera quality is too low. Lens is dirty. Camera is installed against the light. Camera aperture setup is not correct.
- HDD capacity is not enough.
- HDD is damaged.

23. Cannot playback the downloaded file.

There are following possibilities:

- There is no media player.
- No DXB8.1 or higher graphic acceleration software.
- There is no DivX503Bundle.exe control when you play the file transformed to AVI via media player.
- No DivX503Bundle.exe or ffdshow-2004 1012 .exe in Windows XP OS.

24. Forget local menu operation password or network password

Please contact your local service engineer or our sales person for help. We can guide you to solve this problem.

25. When I login via HTTPS, a dialogue says the certificate for this website is for other address.

Please follow chapter 5.10.5.14.3.1 to create server certificate.

26. When I login via HTTPS, a dialogue says the certificate is not trusted.

Please follow chapter 5.10.5.14.3.2 to download root certificate.

27. When I login via HTTPS, a dialogue says the certificate has expired or is not valid yet.

Please make sure your PC time is the same as the device time.

28. I connect the general analog camera to the device, there is no video output.

There are following possibilities:

- Check camera power supplying, data cable connection and etc.
- This series device does not support the analog camera of all brands. Please make sure the device supports general standard definition analog camera.

29. I connect the standard definition analog camera or the HDCVI camera to the device, there is no video output.

There are following possibilities:

- Check camera power supplying, or camera data cable connection.
- For the product supports analog standard definition camera/HD camera, you need to go to the main menu->Setting->Camera->Channel type to select corresponding channel type and then restart the DVR.

30. I cannot connect to the IP channel.

There are following possibilities:

- Check the camera is online or not.
- Check IP channel setup is right or not (such as IP address, user name, password, connection protocol, port number.).
- The camera has set the whitelist (Only the specified devices can connect to the camera).

31. After I connected to the IP channel, there one-window output is OK, but there is no multiple-window output.

There are following possibilities:

- Check the sub stream of the camera has been enabled or not.
- Check the sub stream type of the camera is H.264 or not.
- Check the device supports camera sub stream resolution or not (such as 960H, D1, HD1 and etc.).

32. After I connected to the IP channel, there multiple-window output is OK, but there is no one-window output.

There are following possibilities:

- Check there is video from the IP channel or not. Please go to the main menu->info->System->BPS to view bit stream real-time information.
- Check the main stream of the camera has been enabled or not.
- Check the main stream type of the camera is H.264 or not.
- Check the device supports camera main stream resolution or not (such as 960H, D1, HD1 and etc.).
- Check camera network transmission has reached the threshold or not. Please check the online user of the camera.

33. After I connected to the IP channel, there is no video output in the one-window or the multiple-window mode. But I can see there is bit stream.

There are following possibilities:

- Check the main stream/sub stream type of the camera is H.264 or not.
- Check the device supports camera main stream/sub stream resolution or not (such as 1080P, 720P, 960H, D1, HD1 and etc.).

- Check the camera setup. Please make sure It supports the products of other manufacturers.

34. DDNS registration failed or cannot access the device domain name.

There are following possibilities:

- Check the device is connected to the WAN. Please check the device has got the IP address if the PPPoE can dial. If there is a router, please check the router to make sure the device IP is online.
- Check the corresponding protocol of the DDNS is enabled. Check the DDNS function is OK or not.
- Check DNS setup is right or not. Default Google DNS server is 8.8.8.8, 8.8.5.5. You can use different DNS provided by your ISP.

35. I cannot use the P2P function on my cell phone or the WEB.

There are following possibilities:

- Check the device P2P function is enabled or not. (Main menu->Setting->Network->P2P)
- Check the device is in the WAN or not.
- Check cell phone P2P login mode is right or not.
- It is the specified device P2P login port or not when you are using P2P client.
- Check user name or password is right or not.
- Check P2P SN is right or not. You can use the cell phone to scan the QR code on the device P2P interface (Main menu->Setting->Network->P2P), or you can use the version information of the WEB to confirm. (For some previous series products, the device SN is the main board SN, it may result in error.)

36. I connect the standard definition camera to the device, there is no video output.

There are following possibilities:

- Check the DVR supports standard definition signal or not. Only some series product supports analog standard definition signal, HDCVI signal input.
- Check channel type is right or not. For the product supports analog standard definition camera/HD camera, you need to go to the main menu->Setting->Camera->Channel type to select corresponding channel type (such as analog) and then restart the DVR. In this way, the DVR can recognize the analog standard definition.
- Check camera power supplying, or camera data cable connection.

37. I cannot connect to the IP camera.

There are following possibilities:

- Check DVR supports IP channel or not. Only some series products support A/D switch function, it can switch analog channel to the IP channel to connect to the IP camera. From Setting->Camera->Channel Type, select the last channel to

switch to the IP channel. Some series product products support IP channel extension, it supports N+N mode.

- Check the IPC and the DVR is connected or not. Please go to the main menu->Setting->Camera->Remote to search to view the IP camera is online or not. Or you can go to the main menu->Info->Network->Test, you can input IP camera IP address and then click the Test button to check you can connect to the IP camera or not.
- Check IP channel setup is right or not (such as IP address, manufacturer, port, user name, password, remote channel number and etc.).

Daily Maintenance

- Please use the brush to clean the board, socket connector and the chassis regularly.
- The device shall be soundly earthed in case there is audio/video disturbance. Keep the device away from the static voltage or induced voltage.
- Please unplug the power cable before you remove the audio/video signal cable, RS232 or RS485 cable.
- Do not connect the TV to the local video output port (VOUT).It may result in video output circuit.
- Always shut down the device properly. Please use the shutdown function in the menu, or you can press the power button in the front panel for at least three seconds to shut down the device. Otherwise it may result in HDD malfunction.
- Please make sure the device is away from the direct sunlight or other heating sources. Please keep the sound ventilation.
- Please check and maintain the device regularly.

Appendix AHDD Capacity Calculation

Calculate total capacity needed by each DVR according to video recording (video recording type and video file storage time).

Step 1: According to Formula (1) to calculate storage capacity q_i that is the capacity of each channel needed for each hour, unit Mbyte.

$$q_i = d_i \div 8 \times 3600 \div 1024 \quad (1)$$

In the formula: d_i means the bit rate, unit Kbit/s

Step 2: After video time requirement is confirmed, according to Formula (2) to calculate the storage capacity m_i , which is storage of each channel needed unit Mbyte.

$$m_i = q_i \times h_i \times D_i \quad (2)$$

In the formula:

h_i means the recording time for each day (hour)

D_i means number of days for which the video shall be

kept

Step 3: According to Formula (3) to calculate total capacity (accumulation) q_T that is needed for all channels in the DVR during **scheduled video recording**.

$$q_T = \sum_{i=1}^c m_i \quad (3)$$

In the formula: c means total number of channels in one DVR

Step 4: According to Formula (4) to calculate total capacity (accumulation) q_T that is needed for all channels in DVR during **alarm video recording (including motion detection)**.

$$q_T = \sum_{i=1}^c m_i \times a\% \quad (4)$$

In the formula: $a\%$ means alarm occurrence rate

You can refer to the following sheet for the file size in one hour per channel. (All the data listed below are for reference only.)

Bit stream size (max)	File size	Bit stream size (max)	File size
96K	42M	128K	56M
160K	70M	192K	84M
224K	98M	256K	112M
320K	140M	384K	168M

448K	196M	512K	225M
640K	281M	768K	337M
896K	393M	1024K	450M
1280K	562M	1536K	675M
1792K	787M	2048K	900M

Appendix B Compatible backup devices

Appendix B-1 Compatible USB list

Manu factor	Model	Capacity
Sandisk	Cruzer Micro	512M
Sandisk	Cruzer Micro	1G
Sandisk	Cruzer Micro	2G
Sandisk	Cruzer Freedom	256M
Sandisk	Cruzer Freedom	512M
Sandisk	Cruzer Freedom	1G
Sandisk	Cruzer Freedom	2G
Kingston	DataTraveler II	1G
Kingston	DataTraveler II	2G
Kingston	DataTraveler	1G
Kingston	DataTraveler	2G
Maxell	USB Flash Stick	128M
Maxell	USB Flash Stick	256M
Maxell	USB Flash Stick	512M
Maxell	USB Flash Stick	1G
Maxell	USB Flash Stick	2G
Kingax	Super Stick	128M
Kingax	Super Stick	256M
Kingax	Super Stick	512M
Kingax	Super Stick	1G
Kingax	Super Stick	2G
Netac	U210	128M
Netac	U210	256M
Netac	U210	512M
Netac	U210	1G
Netac	U210	2G
Netac	U208	4G
Teclast	Ti Cool	128M
Teclast	Ti Cool	256M
Teclast	Ti Cool	512M
Teclast	Ti Cool	1G
SanDisk	cruzer mirco	2G
SanDisk	cruzer mirco	8G
SanDisk	Ti Cool	2G
SanDisk	Hongjiao	4G
Lexar	Lexar	256MB
Kingston	Data Traveler	1G
Kingston	Data Traveler	16GB

Kingston	Data Traveler	32GB
Aigo	L8315	16GB
Sandisk	250	16GB
Kingston	Data Traveler Locker+	32GB
Netac	U228	8GB

Appendix B-2 Compatible SD Card list

Brand	Standard	Capacity	Card type
Transcend	SDHC6	16GB	Big
Kingston	SDHC4	4GB	Big
Kingston	SD	2GB	Big
Kingston	SD	1GB	Big
Sandisk	SDHC2	8GB	Small
Sandisk	SD	1GB	Small

Appendix B-3 Compatible Portable HDD list

Brand	Model	Capacity
YDStar	YDstar HDD box	40G
Netac	Netac	80G
Iomega	Iomega RPHD-CG" RNAJ50U287	250GB
WD Elements	WCAVY1205901	1.5TB
Newsmy	Liangjian	320GB
WD Elements	WDBAAR5000ABK-00	500GB
WD Elements	WDBAAU0015HBK-00	1.5TB
Seagate	FreeAgent Go(ST905003F)	500GB
Aigo	H8169	500GB

Appendix B-4 Compatible USB DVD List

Brand	Model
Samsung	SE-S084
BenQ	LD2000-2K4

Appendix B-5 Compatible SATA DVD List

Brand	Model
LG	GH22NS30
Samsung	TS-H653 Ver.A

Samsung	TS-H653 Ver.F
Samsung	SH-224BB/CHXH
SONY	DRU-V200S
SONY	DRU-845S
SONY	AW-G170S
Pioneer	DVR-217CH

Appendix B-6 Compatible SATA HDD List

Please upgrade the DVR firmware to latest version to ensure the accuracy of the table below.

Size	Type	Brand	Model	Environment	Volume	
3.5" HDD	Surveillance hard disk	Seagate	ST1000VM002	DVR with 4 HDDs or below	1T	
			ST2000VM003	16ch HD video recording	2T	
			ST3000VM002	Don't support RAID	3T	
			ST4000VM000		4T	
			ST1000VX000	DVR with 8 HDDs or below	1T	
			ST2000VX000	32ch HD video recording	2T	
			ST3000VX000	Don't support RAID	3T	
			ST1000VX002		1T	
			ST2000VX004		2T	
			ST3000VX004		3T	
			ST1000VX001	DVR with 8 HDDs or below	1T	
			ST1000VX005	64ch HD video recording	1T	
			ST2000VX003	Don't support RAID	2T	
			ST2000VX008		2T	
			ST3000VX006		3T	
			ST3000VX010		3T	
			ST4000VX000		Build RAID	4T
			ST4000VX007		DVR with 8 HDDs or below	4T
			ST5000VX0001	64ch HD video recording	5T	
			ST6000VX0001	If there is no raid in device	6T	
			ST6000VX0023	DVR with 16 HDDs or below	6T	
			ST6000VX0003	64ch HD video recording	6T	
			ST8000VX0002		8T	
			ST8000VX0022		8T	
			ST100000VX0004		10T	
			ST1000VX003		DVR with 8 HDDs or below	1T
			ST2000VX005	64ch HD video recording	2T	
			ST3000VX005	Don't support RAID	3T	
ST4000VX002	Build RAID	4T				

3.5" HDD			ST5000VX0011	DVR with 8 HDDs or below 64ch HD video recording	5T
			ST6000VX0011	If there is no raid in device	6T
			ST8000VX0012	DVR with 16 HDDs or below 64ch HD video recording	8T
		WD	WD10EURX (EOL)	DVR with 8 HDDs or below 32ch HD video recording Don't support RAID	1T
			WD20EURX (EOL)		2T
			WD30EURX (EOL)		3T
			WD40EURX (EOL)		4T
			WD10PURX	DVR with 8 HDDs or below 32ch HD video recording Don't support RAID	1T
			WD20PURX		2T
			WD30PURX		3T
			WD40PURX		4T
			WD50PURX		5T
			WD60PURX		6T
			WD80PUZX		8T
			WD10PURZ		1T
			WD20PURZ		2T
			WD30PURZ		3T
			WD40PURZ	4T	
			WD50PURZ	5T	
			WD60PURZ	6T	
			WD80PURZ	8T	
			WD4NPURX	Build RAID DVR with 8 HDDs or below 64ch HD video recording If there is no raid in device	4T
			WD6NPURX		DVR with 16 HDDs or below 64ch HD video recording 6T
		TOSHIB A	DT01ABA100V	DVR with 8 HDDs or below 16ch HD video recording Don't support RAID	1T
			DT01ABA200V		2T
			DT01ABA300V		3T
			MD03ACA200V	DVR with 8 HDDs or below 32ch HD video recording Don't support RAID	2T
			MD03ACA300V		3T
			MD03ACA400V		4T
			MD04ABA400V		4T
MD04ABA500V	5T				
Enterprise	Seagate	ST1000NM003	DVR with SATA interface,	1T	

hard disk	3	especially for device with 16 HDDs or more and need to build RAID. For large capacity hard disk, please consider the power supply of DVR.	
	ST2000NM003		2T
	3		
	ST3000NM003		3T
	3		
	ST4000NM003		4T
	3		
	ST1000NM005		1T
	5		
	ST2000NM005		2T
	5		
	ST3000NM000		3T
	5		
	ST4000NM003		4T
	5		
	ST6000NM011	6T	
	5		
	ST8000NM005	8T	
	5		
	ST10000NM00	10T	
	16		
	ST4000NM002	4T	
	4		
	ST6000NM002	6T	
4			
ST1000NM002	DVR product with SAS interface, especially for device with 16 HDDs or more and need to build RAID. For large capacity hard disk, please consider the power supply of DVR.	1T	
3			
ST2000NM002		2T	
3			
ST3000NM002		3T	
3			
ST4000NM002		4T	
3			
ST6000NM001		6T	
4			
ST1000NM004		1T	
5			
ST2000NM004		2T	
5			
ST3000NM002	3T		
5			
ST4000NM002	4T		
5			
ST6000NM009	6T		

			5		
			ST6000NM003		6T
			4		
			ST8000NM007		8T
			5		
		WD	WD1003FBYZ	DVR product with SATA interface, especially for device with 16 HDDs or more and need to build RAID.	1T
			WD1004FBYZ (replace WD1003FBYZ)		1T
			WD2000FYYZ	For large capacity hard disk, please consider the power supply of DVR.	2T
			WD2004FBYZ (replace WD2000FYYZ)		2T
			WD3000FYYZ		3T
			WD4000FYYZ		4T
			WD2000F9YZ	DVR product with SATA interface, especially for device with 16 HDDs or more and need to build RAID.	2T
			WD3000F9YZ		3T
			WD4000F9YZ	For large capacity hard disk, please consider the power supply of DVR.	4T
			WD4002FYYZ		4T
			WD6001FSYZ	For large capacity hard disk, please consider the power supply of DVR.	6T
			WD6002FRYZ		6T
			WD8002FRYZ		8T
		HITACHI	HUS724030AL A640	DVR product with SATA interface, especially for device with 16 HDDs or more and need to build RAID.	3T
			HUS726060AL E610		6T
			HUH728060AL E600	For large capacity hard disk, please consider the power supply of DVR.	6T
			HUH728080AL E600		8T
			HUS726020AL 5210	DVR product with SAS interface, especially for device with 16 HDDs or more and need to build RAID.	2T
			HUS726040AL 5210		4T
			HUS726060AL 5210		6T
2.5" HDD	Surveillance hard disk	Seagate	ST320VT000	Product using 2.5" HDD, with 8 HDDs or below 32ch HD video recording	320G
			ST500VT000		500G
			ST2000LM003(EOL)		2T
		TOSHIBA	MQ01ABD050 V	Product using 2.5" HDD, with 8 HDDs or below	500G

			MQ01ABD100 V	32ch HD video recording	1T
	Enterprise hard disk	Seagate	ST1000NX031 3	Cloud storage product using 2.5" HDD.	1T
			ST2000NX025 3		2T

Appendix C Compatible CD/DVD Burner List

NOTE: Please upgrade the DVR firmware to latest version to ensure the accuracy of the table below. And you can use the USB cable with the model recommended to set USB burner.

Manufacturer	Model	Port Type	Type
Sony	DRX-S50U	USB	DVD-RW
Sony	DRX-S70U	USB	DVD-RW
Sony	AW-G170S	SATA	DVD-RW
Samsung	TS-H653A	SATA	DVD-RW
Panasonic	SW-9588-C	SATA	DVD-RW
Sony	DRX-S50U	USB	DVD-RW
BenQ	5232WI	USB	DVD-RW

Appendix D Compatible Displayer List

Please refer to the following sheet form compatible displayer list.

Brand	Model	Dimension (Unit: inch)
BENQ (LCD)	ET-0007-TA	19-inch (wide screen)
DELL (LCD)	E178FPc	17-inch
BENQ (LCD)	Q7T4	17-inch
BENQ (LCD)	Q7T3	17-inch
HFNOVO (LCD)	LXB-L17C	17-inch
SANGSUNG (LCD)	225BW	22 寸(wide screen)
HFNOVO(CRT)	LXB-FD17069HB	17 -inch
HFNOVO(CRT)	LXB-HF769A	17-inch
HFNOVO(CRT)	LX-GJ556D	17-inch
Samsung (LCD)	2494HS	24-inch
Samsung (LCD)	P2350	23-inch
Samsung (LCD)	P2250	22-inch
Samsung (LCD)	P2370G	23-inch
Samsung (LCD)	2043	20-inch
Samsung (LCD)	2243EW	22-inch
Samsung (LCD)	SMT-1922P	19-inch
Samsung (LCD)	T190	19-inch
Samsung (LCD)	T240	24-inch
LG (LCD)	W1942SP	19-inch
LG (LCD)	W2243S	22-inch
LG (LCD)	W2343T	23-inch
BENQ (LCD)	G900HD	18.5-inch
BENQ(LCD)	G2220HD	22-inch
PHILIPS (LCD)	230E	23-inch
PHILIPS (LCD)	220CW9	23-inch
PHILIPS (LCD)	220BW9	24-inch
PHILIPS (LCD)	220EW9	25-inch

Appendix E Compatible Switcher

Brand	Model	network working mode
D-Link	DES-1016D	10/100M self-adaptive
D-Link	DES-1008D	10/100M self-adaptive
Ruijie	RG-S1926S	Five network modes 1. AUTO 2. HALF-10M 3. FULL-10M 4. HALF-100M 5. FULL-100M
H3C	H3C-S1024	10/100M self-adaptive
TP-LINK	TL-SF1016	10/100M self-adaptive
TP-LINK	TL-SF1008+	10/100M self-adaptive

Appendix F Compatible Wireless Mouse List

Please refer to the following sheet for compatible SD card brand.

Brand	Model
SUNT 讯拓™	V80
Rapoo	3500
Logitech	M215
Shuangfeiyan	Tianyao G7-630

Appendix G Earthing

1. What is the surge?

Surge is a short current or voltage change during a very short time. In the circuit, it lasts for microsecond. In a 220V circuit, the 5KV or 10KV voltage change during a very short time (about microseconds) can be called a surge. The surge comes from two ways: external surge and internal surge.

- The external surge: The external surge mainly comes from the thunder lightning. Or it comes from the voltage change during the on/off operation in the electric power cable.
- The internal surge: The research finds 88% of the surge from the low voltage comes from the internal of the building such as the air conditioning, elevator, electric welding, air compressor, water pump, power button, duplicating machine and other device of inductive load.

The lightning surge is far above the load level the PC or the micro devices can support. In most cases, the surge can result in electric device chip damage, PC error code, accelerating the part aging, data loss and etc. Even when a small 20 horsepower inductive engine boots up or stops, the surge can reach 3000V to 50000V, which can adversely affect the electronic devices that use the same distribution box.

To protect the device, you need to evaluate its environment, the lightning affection degree objectively. Because surge has close relationship with the voltage amplitude, frequency, network structure, device voltage-resistance, protection level, ground and etc. The thunder proof work shall be a systematic project, emphasizing the all-round protection (including building, transmission cable, device, ground and etc.). There shall be comprehensive management and the measures shall be scientific, reliable, practical and economic. Considering the high voltage during the inductive thundering, the International Electrotechnical Committee (IEC) standard on the energy absorbing step by step theory and magnitude classification in the protection zone, you need to prepare multiple precaution levels.

You can use the lightning rod, lightning strap or the lightning net to reduce the damage to the building, personal injury or the property,

- The lightning protection device can be divided into three types:
Power lightning arrester: There are 220V single-phrase lightning arrester and 380V three-phrase lightening arrester (mainly in parallel connection, sometimes use series connection) You can parallel connect the power lightning arrester in the electric cable to reduce the short-time voltage change and release the surge current. From the BUS to the device, there are usually three levels so that system can reduce the voltage and release the current step by step to remove the thunderstorm energy and guarantee the device safety. You can select the replaceable module type, the terminal connection type and portable socket according to your requirement.

- Signal lightning arrester: This device is mainly used in the PC network, communication system. The connection type is serial connection. Once you connected the signal lightning arrester with the signal port, it can cut the channel of the thunderstorm to the device, and on the other hand, it can discharge the current to the ground to guarantee the device proper work. The signal lightning arrester has many specifications, and widely used in many devices such as telephone, network, analog communication, digital communication, cable TV and satellite antenna. For all the input port, especially those from the outdoor, you need to install the signal lightning arrester.
- Antenna feed cable lightning arrester: It is suitable for antenna system of the transmitter or the device system to receive the wireless signal. It uses the serial connection too.

Please note, when you select the lightning arrester, please pay attention to the port type and the earthing reliability. In some important environment, you need to use special shielded cable. Do not parallel connect the thunder proof ground cable with the ground cable of the lightning rod. Please make sure they are far enough and grounded respectively.

2. The earthing modes

We all know the earthing is the most complicated technology in the electromagnetism compatibility design since there is no systematic theory or module. The earthing has many modes, but the selection depends on the system structure and performance. The following are some successfully experience from our past work.

One-point ground: In the following figure you can see there is a one-point ground. This connection provides common port to allow signal to be transmitted in many circuits. If there is no common port, the error signal transmission occurred. In the one-point ground mode, each circuit is just grounded only and they are connected at the same port. Since there is only one common port, there is no circuit and so, there is no interference.

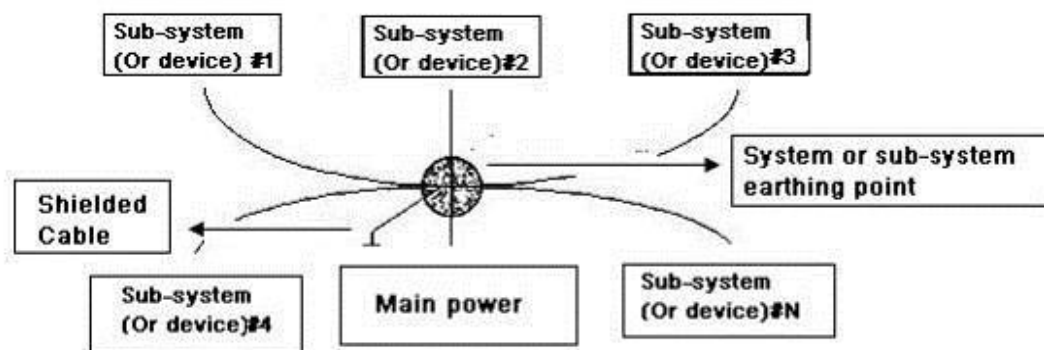

Multiple-point ground: In the following figure, you can see the internal circuit uses the chassis as the common point. While at the same time, all devices chassis use the earthing as the common port. In this connection, the ground structure can provide the lower ground resistance because when there are multiple-point grounds; each ground cable is as short as possible. And the parallel cable connection can reduce the total

conductance of the ground conductor. In the high-frequency circuit, you need to use the multiple-point ground mode and each cable needs to connect to the ground. The length shall be less than the 1/20 of the signal wavelength.

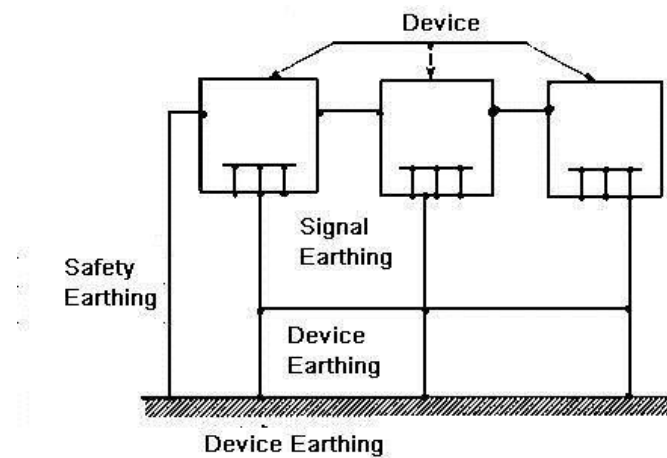

Mixed ground: The mixed ground consists of the feature of the one-point ground and multiple-point ground. For example, the power in the system needs to use the one-point ground mode while the radio frequency signal requires the multiple-point ground. So, you can use the following figure to earth. For the direct current (DC), the capacitance is open circuit and the circuit is one-point ground. For the radio frequency signal, the capacitance is conductive and the circuit adopts multiple-point ground.

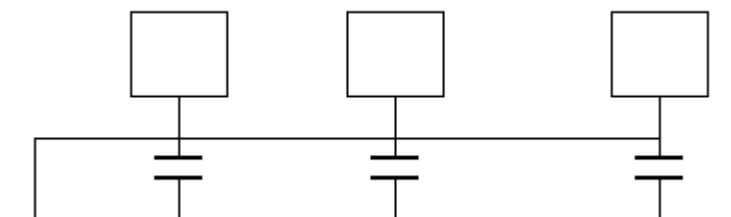

When connecting devices of huge size (the device physical dimension and connection cable is big comparing with the wave path of existed interference), then there are possibility of interference when the current goes through the chassis and cable. In this situation, the interference circuit path usually lies in the system ground circuit.

When considering the earthing, you need to think about two aspects: The first is the system compatibility, and the other is the external interference coupling into the earth circuit, which results in system error. For the external interference is not regular, it is not easy to resolve.

3. Thunder proof ground method in the monitor system

- The monitor system shall have sound thunder proof earthing to guarantee personnel safety and device safety.
- The monitor system working ground resistance shall be less than 1Ω.

- The thunder proof ground shall adopt the special ground cable from the monitor control room to the ground object. The ground cable adopts copper insulation cable or wire and its ground section shall be more than 20mm².
- The ground cable of the monitor system can not short circuit or mixed connected with the strong alternative current cable.
- For all the ground cables from the control room to the monitor system or ground cable of other monitor devices, please use the copper resistance soft cable and its section shall be more than 4mm².
- The monitor system usually can adopt the one-point ground.
- Please connect the ground end of 3-pin socket in the monitor system to the ground port of the system (protection ground cable)

4. The shortcut way to check the electric system using the digital multimeter

For 220V AC socket, from the top to the bottom, E (ground cable), N (neutral cable), L(live cable). Please refer to the following figure.

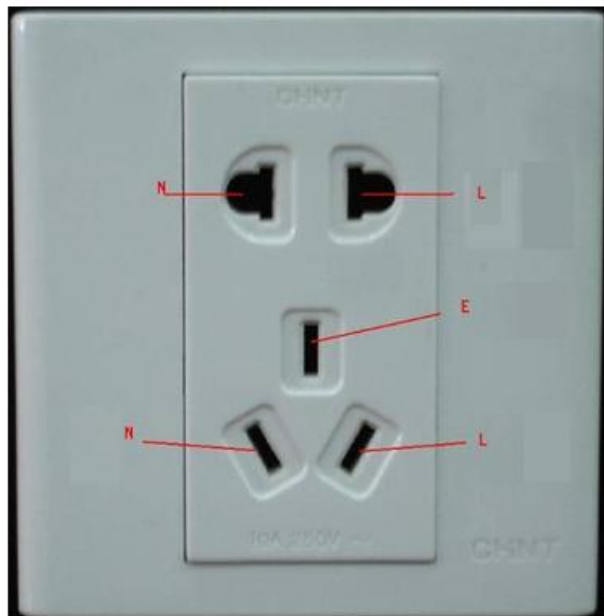

There is a shortcut way to check these three cables connection are standard or not (not the accurate check).

Importance

In the following operations, the multimeter range shall be at 750V!

For E (earth cable)

Turn the digital multimeter to 750V AC, use your one hand to hold the metal end, and then the other hand insert the pen to the E port of the socket. See the following figure. If the multimeter shows 0, then you can see current earth cable connection is standard. If the value is more than 10, then you can see there is inductive current and the earth cable connection is not proper.



For L (live cable)

Turn the digital multimeter to 750V AC, use your one hand to hold the metal end, and then the other hand insert the pen to the L port of the socket. See the following figure. If the multimeter shows 120, then you can see current live cable connection is standard. If the value is less than 60, then you can see current live cable connection is not proper or it is not the live cable at all.



For N (Neutral cable)

Turn the digital multimeter to 750V AC, use your one hand to hold the metal end, and then the other hand insert the pen to the N port of the socket. See the following figure. If the multimeter shows 0, then you can see current N cable connection is standard. If the value is more than 10, then you can see there is inductive current and the neutral cable connection is not proper. If the value is 120, then you can know misconnected the neutral cable to the live cable.

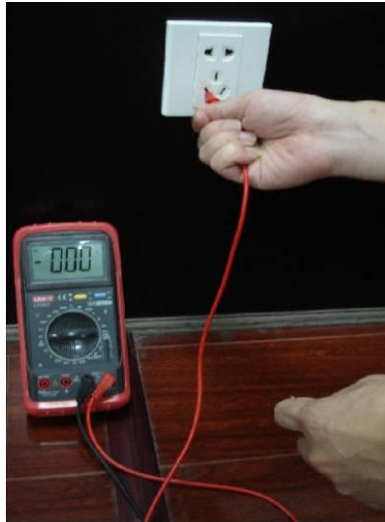

 **Note**

- **This manual for reference only. Slight difference may be found in the user interface.**
- **All the designs and software here are subject to change without prior written notice.**
- **All trademarks and registered trademarks mentioned are the properties of their respective owners.**
- **If there is any uncertainty or controversy, please refer to the final explanation of us.**
- **Please visit our website or contact your local retailer for more information.**

ZHEJIANG DAHUA VISION TECHNOLOGY CO.,LTD.

Address: No. 1199 Bin'an Road, Binjiang District, Hangzhou, China.

Postcode: 310053

Tel: +86-571-87688883

Fax: +86-571-87688815

Email: overseas@dahuasecurity.com

Website: www.dahuasecurity.com